

SPONSORED BY THE



Federal Ministry  
of Education  
and Research



**DECHEMA**

Gesellschaft für Chemische Technik  
und Biotechnologie e.V.

Results of the BMBF funding measure

# Technologies for Sustainability and Climate Protection – Chemical Processes and Use of CO<sub>2</sub>

Alexis Bazzanella, Dennis Krämer (Editors)



SPONSORED BY THE



Federal Ministry  
of Education  
and Research



**DECHEMA**

Gesellschaft für Chemische Technik  
und Biotechnologie e.V.

**Publisher:**

DECHEMA Gesellschaft für Chemische Technik und Biotechnologie e.V.  
Theodor-Heuss-Allee 25  
60486 Frankfurt/Main  
Germany

Dr. Alexis Bazzanella

Phone: +49 69 7564 343

Email: alexis.bazzanella@dechema.de

Dennis Krämer

Phone: +49 69 7564 618

Email: dennis.kraemer@dechema.de

**Layout:**

PM-Grafikdesign

Peter Mück

63607 Wächtersbach

Germany

Email: mueck@pm-grafikdesign.de

**Printed by:**

Seltersdruck & Verlag Lehn GmbH + Co. KG.

65618 Selters (Taunus)

Germany

Email: info@seltersdruck.de

ISBN 978-3-89746-200-7

Date: January 2019

The project on which this report is based was funded by the Federal Ministry of Education and Research. The responsibility for the content of this publication lies with the respective authors..

**Images:**

Front cover: © Thinkstock; page 2: © Presse- und Informationsamt der Bundesregierung-Jesco Denzel;

Page 107: © frank peters-stock.adobe.com; Seite 276: © Thinkstock-NicoElNino

---

---

**Results of the BMBF funding measure**

# **Technologies for Sustainability and Climate Protection – Chemical Processes and Use of CO<sub>2</sub>**

Alexis Bazzanella, Dennis Krämer (Editors)





## Foreword by Dr. Georg Schütte, State Secretary at the Federal Ministry of Education and Research

When it comes to identifying the greatest global challenges currently faced, the impact of climate change and the need to reduce global dependence on fossil fuels are seen to be two sides of the same coin. Finding solutions and proposing new courses of action are key objectives of the scientific and research communities. But the road to a green economy is not without its obstacles and new approaches are therefore needed to resolve controversial issues and to identify the right path to take.

One example of this type of new approach is the use of carbon dioxide as a material resource. As a greenhouse gas, CO<sub>2</sub> is present in almost inexhaustible quantities and making use of it as a chemical feedstock will lessen the chemical industry's dependence on oil as the main source of the carbon building blocks that the chemical sector requires. This not only broadens the raw materials base in the chemical industry, it also reduces consumption of petroleum feedstocks. Carbon emissions will also be correspondingly lower. In combination with renewable energy sources, CO<sub>2</sub> can be converted into sustainable energy storage materials and fuels.

In the period from 2010 to 2016, the funding programme 'Technologies for Sustainability and Climate Protection – Chemical Processes and Use of CO<sub>2</sub>' supported a total of 33 collaborative projects. In this globally unique research programme, the German Federal Ministry of Education and Research (BMBF) provided 100 million euros to support the three main areas: 'CO<sub>2</sub> Utilisation', 'Chemical energy storage systems' and 'Energy-efficient chemical processes'. A further 50 million euros in funding was injected by participating companies. The projects in the research programme have helped to position Germany at the very forefront of technology development in this highly innovative sector. In one of the funded projects, for example, synthetic diesel was produced for the first time from CO<sub>2</sub>, water and renewable energy. The first industrial facility for the production of CO<sub>2</sub>-based foam components is now on stream. These and other results from the research programme are described in detail in this publication.

The success achieved shows that we are on the right path. There is, however, still a significant need for more research in key technological areas, such as photocatalysis and electrocatalysis. The BMBF has therefore decided to fund a follow-up programme entitled 'CO<sub>2</sub>Plus – Utilisation of CO<sub>2</sub> to Expand the Resource Base', which will run until 2019 and will support a further 13 collaborative projects with partners from academia and industry who will be addressing presently unresolved questions regarding CO<sub>2</sub> capture and utilisation.

The BMBF will continue to cooperate with innovative companies in order to transform promising research results into industrial applications and thus deliver key research-driven input aimed at achieving a sustainable economy.

A handwritten signature in black ink, appearing to read 'Georg Schütte', written in a cursive style.

Dr. Georg Schütte  
State Secretary at the Federal Ministry  
of Education and Research

**Dear reader,**

Over the last few years, public awareness and understanding of the concept of using carbon dioxide as a material resource have been raised through articles in nearly all major German newspapers, through specialist books and publications, papers in scientific and technical journals, events and even television reports. The depth of coverage has ranged from the very broad and general to the highly specific and academic. Newspaper articles and specialist technical papers can of course only ever cover certain parts or specific aspects of the field. On the other hand, the books published on the subject are highly specialised and academic in nature. Our aim with this final report on the research and development programme 'Technologies for Sustainability and Climate Protection – Chemical Processes and Use of CO<sub>2</sub>' that was funded by the German Federal Ministry of Education and Research (BMBF) has been to bridge the gap between the very general and the highly specific and to present a comprehensive review of this important field to the widest possible audience. The report is structured to give readers the opportunity to move from a general overview of the field to more detailed descriptions and discussions of the current state of the art. We believe that this report offers something of value for interested members of the general public as well as to experts working in the field.

The BMBF-funded research and development programme 'Technologies for Sustainability and Climate Protection – Chemical Processes and Use of CO<sub>2</sub>' ran from 2010 to the end of 2016 and covered the following main areas: 'Using CO<sub>2</sub> as a material resource', 'Chemical energy storage' and 'Energy-efficient processes'. Each of these main areas is accompanied in this final report by a review article that provides a comprehensive overview of the topic. The 33 projects that received funding have been classified into these three main areas or clusters. A short article has been provided for each research project and focuses on presenting the central results of the project. In the 'Energy-efficient processes' cluster, the review article, which covers the subject of carbon capture, serves as an example of the very diverse range of projects grouped in this part of the report.

The BMBF-funded research and development programme also included an accompanying impact assessment and communication project that was managed by DECHEMA and as part of which academics at Berlin Technical University analysed the potential leverage that can be achieved by the programme. The CO<sub>2</sub>Net project also attempted to establish a consensus on a uniform approach to conducting life cycle assessments (LCAs) for research projects concerned with utilising CO<sub>2</sub> as a material resource. As a result of that work, it was decided to include a specialist article that provides practical guidelines on conducting LCAs. Chapter 4 therefore offers methodological guidance drawn up by a team of authors from the ifeu Institute for Energy and Environmental Research on implementing carbon accounting mechanisms for processes in the chemical industry.

The objective of the Federal Ministry of Education and Research, the project organisers and the members of the impact assessment and communication project team was to identify early on any synergies that existed between the research projects and to encourage and promote their use. Exploiting such synergies would, however, not have been possible without the support of the project teams themselves. The same is true for the organisation of a series of successful conferences, workshops and other PR events. We would therefore like to convey our sincere thanks to all those involved in the funded projects and express our gratitude for the outstanding support we have received throughout the programme. This applies in particular to the work required to compile this final report in book form, especially in view of the fact that a number of projects were completed two years before the book's publication date.

The editors would also like to thank the authors of the various articles and Mr Mück for his work on the graphical layout of the publication.

The editors

Alexis Bazzanella, Dennis Krämer

	Seite
<b>I Imprint</b>	
<b>II Foreword BMBF – Georg Schütte</b>	2
<b>III Editors' Foreword (DECHEMA)</b>	3
<b>CO<sub>2</sub>Net – Supporting the programme, assessing its impact and communicating the results</b>	6
<b>1 CO<sub>2</sub> Utilization</b>	<b>12</b>
<b>1.1 CO<sub>2</sub> Utilization – Motivation, Challenges, Outlook</b> (Dipl.-Ing. Dennis Krämer, Dr. Alexis Bazzanella, DECHEMA e.V.)	12
Funded Projects:	
1.2 DreamReaction	32
1.3 CO <sub>2</sub> as a polymer building block	37
1.4 DreamProduction	44
1.5 Valery – Energy efficient synthesis of aliphatic aldehydes from alkanes and carbon dioxide: Valeraldehyde from butane and CO <sub>2</sub>	50
1.6 ECCO <sub>2</sub> – Combinatorial electrocatalytic CO <sub>2</sub> reduction	54
1.7 COOBAF – Chemical Processes – Collaborative project: CO <sub>2</sub> -based acetone fermentation	62
1.8 DMEExCO <sub>2</sub> – Integrated dimethyl ether synthesis from methane and CO <sub>2</sub>	68
1.9 DreamPolymers	74
1.10 FfPaG – Solid and liquid products from gases	80
1.11 PhotoKat – Developing active and selective photocatalysts for the reduction of CO <sub>2</sub> to form C1 feedstock	88
1.12 OrgKoKat – New organocatalysts and cooperative catalytic processes for utilising CO <sub>2</sub> as a building block in chemical syntheses	95
1.13 ACER – Sodium acrylate from CO <sub>2</sub> and Ethene	101
<b>2 Chemical Energy Storage</b>	<b>107</b>
<b>2.1 Chemical Energy Storage</b> (Prof. Dr. Michael Sterner, OTH Regensburg)	107
Funded Projects:	
2.2 sunfire – Liquid hydrocarbons from CO <sub>2</sub> , H <sub>2</sub> O and renewable electricity	133
2.3 CO <sub>2</sub> RRECT – Utilisation of CO <sub>2</sub> as a carbon building block using predominantly renewable sources of energy	142
2.4 SEE – Storage of electrical energy from renewable resources in the natural gas grid	149
2.5 iC <sup>4</sup> : integrated Carbon Capture, Conversion and Cycling	154
2.6 SolarStep – Chemicals Research and Engineering	161
2.7 HyCats – New catalysts and technologies for solar chemical hydrogen production	172

	Seite
<b>3 Energy Efficient Processes</b>	<b>178</b>
<b>3.1 Carbon capture</b> (Prof. Klaus Görner, Universität Duisburg-Essen)	<b>178</b>
Funded Projects:	
3.2 EffiCO <sub>2</sub> – New efficient carbon capture solvent	200
3.3 CO <sub>2</sub> -Kompressor – Developing a miniaturised, oil-free CO <sub>2</sub> compressor with an integrated CO <sub>2</sub> -cooled electric motor drive for large-scale CO <sub>2</sub> heat pumps	204
3.4 InnovA <sup>2</sup> – Innovative plant equipment concepts for increasing the efficiency of production processes	210
3.5 Abwärme – Using low-temperature waste heat to drive absorption refrigerators and absorption heat transformers – Novel refrigerant-absorbent pairs	217
3.6 EP-Wüt – Energy-efficient heat exchangers	224
3.7 OPHINA – Organic solvent nanofiltration for energy-efficient processes	232
3.8 LICIL – Methods for Extracting Lignin, Cellulose and Hemicellulose with the Aid of Novel Ionic Liquids	235
3.9 Mixed-Matrix-membranes for gas separation	243
3.10 EManagement – EEnergy efficiency management and benchmarking for the process industry	249
3.11 HY-SILP – Development of novel, resource-saving hydroformylation technologies and use of Supported Ionic Liquid Phase (SILP) catalysts	255
3.12 InReff – Integrated Resource Efficiency for Reducing Climate Impacts in the Chemical Industry	262
3.13 Multi-Phase – Increased energy efficiency and reduced greenhouse gas emissions through use of multi-scale modelling of multi-phase reactors	269
3.14 IL-WIND – Development of IL-based lubricants for wind turbines	272
3.15 SIT – Utilisation of low-calorific industrial heat by means of sorption heat pump systems using ionic liquids and thermochemical accumulators	275
<b>4 Methodological Guidance on Implementing Carbon Accounting Mechanisms for Processes in the Chemical Industry – ifeu Heidelberg</b>	<b>278</b>
(Horst Fehrenbach, Axel Liebich, Jonas Harth, Nabil Abdallah, Andreas Detzel, Balint Simon, Thomas Fröhlich, Jürgen Giegrich, ifeu – Institut für Energie- und Umweltforschung Heidelberg GmbH)	

# CO<sub>2</sub>Net – Supporting the programme, assessing its impact and communicating the results

*Dipl.-Ing. Dennis Krämer, Dr. Alexis Bazzanella, DECHEMA e.V.*



In order to raise awareness and visibility of major research and development programmes and to facilitate networking between the individual collaborative projects within such programmes, the German Federal Ministry of Education and Research (BMBF) funds accompanying impact assessment and communication projects as part of subject-driven R&D programmes. The funding programme ‘Technologies for Sustainability and Climate Protection – Chemical Processes and Use of CO<sub>2</sub>’ was accompanied by the impact assessment and communication project ‘CO<sub>2</sub>Net’, which was carried out by DECHEMA – Society for Chemical Engineering and Biotechnology between 2010 and the end of 2016.

Key objectives of CO<sub>2</sub>Net were to collect, collate and communicate the results from the projects and to encourage networking between projects working in similar areas in order to exploit potential synergies. Other duties within the CO<sub>2</sub>Net project included the preparing and implementing programme-level events, compiling and distributing information materials on the research and development programme, preparing project results for dissemination to different target groups, and forging and maintaining contacts with other comparable European research activities. The central role played by DECHEMA made it ideally suited to accessing the information needed to analyse and assess the impact of the programme. This article reviews the measures carried out as part of the impact assessment and communication project CO<sub>2</sub>Net with detailed descriptions of the most important project elements.

## Exploiting synergies: Identifying and discussing commonalities

Key functions of the CO<sub>2</sub>Net project included identifying areas of content overlap between the collaborative projects funded under the programme and organising opportunities for inter-project knowledge sharing in areas of common interest. In order to be able to identify and discuss synergies, members of the CO<sub>2</sub>Net project team took part in the internal meetings of the individual research projects. The areas of common ground identified in this way were then addressed in discussion meetings to which representatives from the relevant research projects were invited. One particularly important

cross-project topic was that of calculating the carbon footprint of the processes developed in the projects. Each of the projects had its own individual approach. However, the results of these calculations can only be compared if there is some form of consensus with respect to fundamental issues of carbon accounting and allocating environmental burdens. During a series of technical discussion meetings, the project team members responsible for carbon accounting issues worked together to develop a uniform approach and to find a common set of rules governing system boundaries and burden allocation. These cross-project meetings focused predominantly on the use of CO<sub>2</sub> as a material resource.

## Status conferences: A key forum for the CO<sub>2</sub> utilisation community

Over the course of the programme, DECHEMA organised five public status conferences, whose focus was on providing a forum for presenting the projects and their results. The aim was to present the research topics and the results in such a way that they would be of value to both the specialist technical and scientific community and to the broader public. The status conferences drew together members of the expert community and acted as a platform for disseminating information and for networking. The status conferences on utilising CO<sub>2</sub> as a material resource also provided an opportunity for information and ideas from experts who were not receiving funding from within the programme. Over a period of several years, a relatively small area of research grew into a substantial community that included representatives from industry, academia and government. Over the course of the programme and the three consecutive funding periods it was possible to observe how the range of CO<sub>2</sub> utilisation topics grew and developed, how new research concepts were introduced and how they gradually evolved towards industrial implementation and commercialisation. The status confer-



ences were also enhanced by policy discussions to reflect the fact that using CO<sub>2</sub> as a material resource has political relevance to the ongoing transition to a renewables-based energy system and to achieving stated climate protection goals. The presence of high-ranking representatives from industry underscored the willingness of industry to commit time and resources to this important topic.

Government interest and support for the programme were shown when the Minister for Education and Research, Prof. Johanna Wanka, attended the status conferences in 2013 and 2015 in Berlin. A particular highlight of the programme in 2015 was when the minister's official car was filled with sunfire diesel that had been synthesised from water and carbon dioxide using energy from renewable sources. That event showcased just how simply the new fuel could be used without the need to modify any existing infrastructure.



## Data analysis and estimating project impact potential

As the funding body, BMBF is clearly interested in an assessment of the leverage achieved by the programme in relation to its original goals. In the case of the funding programme 'Technologies for Sustainability and Climate Protection – Chemical Processes and Use of CO<sub>2</sub>', such an assessment covers not only the potential economic benefits of the technologies developed during the programme, but also the reductions in energy consumption and CO<sub>2</sub> emissions that can be achieved by implementing these technologies. The



following performance indicators were used to provide a project-independent means of assessing the potential impact of the individual research projects within the programme:

- Reduction in emissions of CO<sub>2</sub> and other greenhouse gases relative to a benchmark process
- Substitution of fossil raw materials
- Reduction in energy consumption
- Estimation of future market potential

As the technologies under development will need to go through a market implementation phase, the values of the indicators were forecast for the years 2020 and 2030. The projects were also asked to make a conservative and an optimistic projection of future development and implementation paths. The aim was to highlight the potential offered by the technologies once they were fully developed and to demonstrate existing barriers to implementation. The forecasts were nevertheless based on the assumption that each project would conclude successfully and that the technology would undergo systematic implementation. The data from the individual projects were collected and grouped into clusters. The results of the project surveys are therefore shown only as aggregate values and the way in which the results were presented to the public did not enable conclusions to be drawn about individual projects. Future potential impact was assessed and the results presented for the three clusters: 'Using CO<sub>2</sub> as a material resource', 'Chemical energy storage' and 'Energy-efficient processes'.

## Presenting the projects in public: PR strategies

One of the central objectives of the CO<sub>2</sub>Net project was the public dissemination and communication of the programme's achievements. The project and the programme were both presented to specialist audiences at a number of different academic and technical conferences. DECHEMA contributed by drafting press releases and penned a number of articles for trade publications during the period 2010 to 2015. In 2012 and 2015, DECHEMA organised a BMBF stand at the ACHEMA international trade fair to present the funding programme 'Technologies for Sustainability and Climate Protection – Chemical Processes and Use of CO<sub>2</sub>'. DECHEMA also organised a session of talks on the subject of utilising CO<sub>2</sub> as a material resource at the ACHEMASIA fair in 2013 in Beijing.





The stand at the ACHEMA 2015 received particularly positive feedback. The aim of the stand was to provide information on the BMBF research and development programme and to showcase the funded projects for experts working in the field and to interested visitors hoping to learn more about the subject. With about 160,000 visitors from 110 countries and over 3800 exhibitors, ACHEMA provided an outstanding PR platform. From 15–19 June 2015, the stand, which was part of the ‘Research and Innovation’ exhibitors group, was home to a range of exciting exhibits and activities related to the BMBF-funded programme. The focus was on presenting the projects in the clusters ‘Using CO<sub>2</sub> as a material resource’ and ‘Chemical energy storage’ with selected projects from the research area ‘Energy-efficient processes’. The stand was designed to create a lively and dynamic atmosphere. With an area covering 180 square metres, the stand housed a model that showcased the CO<sub>2</sub> value chain and included eye-catching exhibits designed to draw attention to the two lighthouse projects ‘Dream Production’ and ‘sunfire’. The different stages of the value chain and the stand exhibits were linked by LED strips, allowing visitors to the stand to follow the value creation process from generation of renewable energy to the production of synthetic fuels or CO<sub>2</sub>-based plastics. Project representatives were on hand to talk about their projects and answer visitors’ questions. In addition to the main model and exhibits, there were also a science rally for school students, a ‘science slam’ and a number of speed presentations. The BMBF stand was a great success not only with visitors but also with those members of the project teams who were on hand to assist and supervise the exhibits and activities. Members of the stand team reported that they had numerous interesting discussions with potential customers, suppliers and even prospective investors.

---

## International contacts and networking

To broaden international awareness and interest in the programme and to initiate new areas of collaborative research, DECHEMA representatives regularly attended international events to establish a broad network of experts working in the field. One of the objectives was to promote the topic of CO<sub>2</sub> utilisation within the European research funding environment. DECHEMA therefore took part in roundtable discussions at the European Chemical Industry Council (Cefic) and in events hosted by the European Commission to stimulate awareness of the topic. The German research activity within this dedicated programme of research and development was seen as both exemplary and pioneering by many EU member states. BMBF also requested that DECHEMA participate in the EU project 'Smart Carbon Dioxide Transformation (SCOT)'. The SCOT project brought together European experts on CO<sub>2</sub> utilisation and led to the creation of a project vision, a roadmap and an action plan. Project members are currently establishing an association to promote CO<sub>2</sub> utilisation. The aim of the association, which will include a large number of industrial stakeholders, is to speak with one voice on behalf of the professional community in an effort to drive forward relevant issues, one particularly important example of which is anchoring this topic within the funding landscape of the EU.

### Outlook: Which areas still require funding and support?

So after five successful years of research and development, is the field of CO<sub>2</sub> utilisation now done and dusted, or is there still a need for more research and financial support? As part of the CO<sub>2</sub>Net impact assessment and communication project, DECHEMA continuously analysed the need for further research in the field of using CO<sub>2</sub> as a material resource. These findings and forecasts were then used to draft recommendations aimed at developing the programme for the future and the results were forwarded to the project organiser and to BMBF. This information identifying areas of future research importance was used to design the BMBF-funded follow-up programme entitled 'CO<sub>2</sub>Plus'.



# 1.1 CO<sub>2</sub> Utilization

## – Motivation, Challenges, Outlook –

*Dipl.-Ing. Dennis Krämer, Dr. Alexis Bazzanella, DECHEMA e.V.*

### 1.1.1 Introduction

#### 1.1.1.1 Motivation

The sustainable use of raw materials, strategies for fighting climate change, and transitioning from conventional to renewable sources of energy are three central challenges of our time, all of which are addressed by current endeavours to achieve the sustainable use of carbon dioxide (CO<sub>2</sub>) as a chemical feedstock. However, the ways in which CO<sub>2</sub> can be utilised and exploited in industrial value chains are both complex and very varied. CO<sub>2</sub> can be used as a raw material for a large number of applications and products, such as plastics, transport fuels and construction materials. But evaluating whether a specific application really does boost sustainability is not a simple exercise. Part of the problem involves identifying a source of CO<sub>2</sub> that is suitable for a particular application, as well as specifying appropriate carbon capture and preuse processing technologies.

This text discusses the motivation behind current work aimed at achieving the industrial utilisation of the chemically inert combustion product CO<sub>2</sub>. The main focus of the discussion is on technological, economic and political aspects.

#### 1.1.1.1.1 Carbon for plastics, petrochemicals and construction materials

Chemistry is all around us and plays a role in every aspect of our lives. The processes that chemically transform primary materials into products have a significant impact on how we live. On the one hand, chemical products improve the standard of living for many people and enable us to save energy and thus reduce carbon emissions to the environment (e.g. through the thermal insulation of buildings); on the other hand, the production processes used in the chemical industry generate emissions themselves and these emissions need to be managed in an environmentally compatible and sustainable way. The process of chemical conversion, the expertise and know-how involved and the associated supply chains are all elements in the overall practice of manufacturing chemical products – but most people going about their daily lives are essentially unaware of these elements. For many consumers, the chemical industry is simply a black box. This is primarily because the chemical industry manufactures products that are themselves the starting materials for other branches of industry. Companies in the chemical industry are therefore predominantly involved in the B2B (business-to-business) sector, in which the consumers of the end products are not involved. Many people are therefore unaware of the extremely broad range of products generated by the chemical industry.

The chemical industry produces a huge number of plastics and polymers and other chemical components that are used in the automotive sector, in

CO<sub>2</sub> as a source of carbon for the chemical industry?

90% of organic chemicals are secondary products generated from fossil carbon resources

### Applications for plastics in Europe 2010

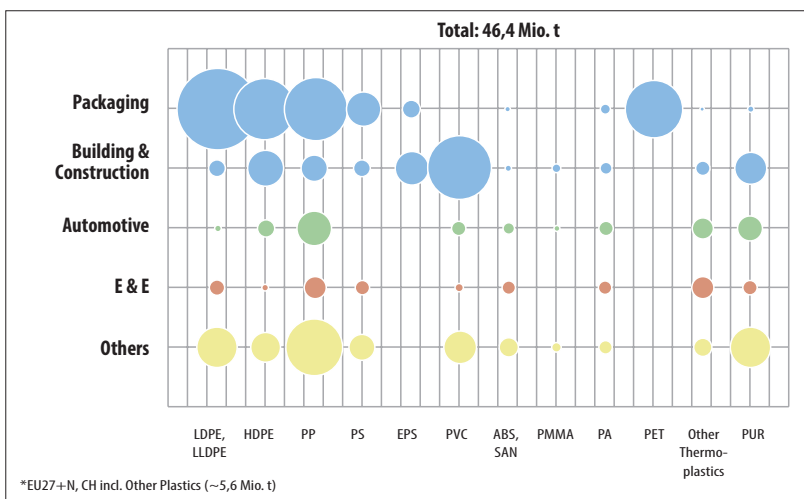

Fig. 1:  
Applications for plastics in Europe 2010  
(Source: PlasticsEurope Market Research Group; © CHEManager)

Will CO<sub>2</sub> be able to replace crude oil in the future?

the construction industry, in cosmetics, in pharmaceutical products and in many other fields. The vast majority of these products are associated with that part of chemistry known as organic chemistry and for which carbon is the essential element. **Carbon**, which is abbreviated in chemistry with the letter 'C', is an element whose electron configuration makes it able to form complex chemical compounds. It is this property of carbon that forms the basis for life on Earth and it enables the formation and processing of a vast number of different molecules by chemical synthesis and conversion. Carbon is present in the natural world in a variety of forms. It is found in a variety of naturally occurring sources, such as carbonates, crude oil, natural gas, coal and carbon dioxide. Currently, however, crude oil is the source of carbon for almost all of the world's plastics, organic chemicals and fuels. In 2017, the German chemical industry consumed around 17.4 million metric tons of fossil resources (petroleum products, natural gas, coal). However, fossil sources of carbon are finite; humans continue to consume in huge quantities a scarce resource that the global economy currently cannot do without or does not want to do without. With finite sources of fossil carbon becoming increasingly scarce, the chemical industry is slowly beginning to lose its conventional raw materials base. In future, therefore, companies in the chemical sector will be forced to use alternative sources of carbon in order to be able to continue to produce the products currently being marketed. The forecasting of future market behaviour is also becoming increasingly uncertain, as such projections rely on taking a large number of variables into account. The increasing scarcity of fossil resources will result in politically influenced and strategic interventions that in turn will drive fluctuations in market prices, making long-term planning of raw material supplies much harder. In mid-2014, the price of oil was around US\$ 115 per barrel. As a result of a fracking boom in the USA and politically motivated strategic moves

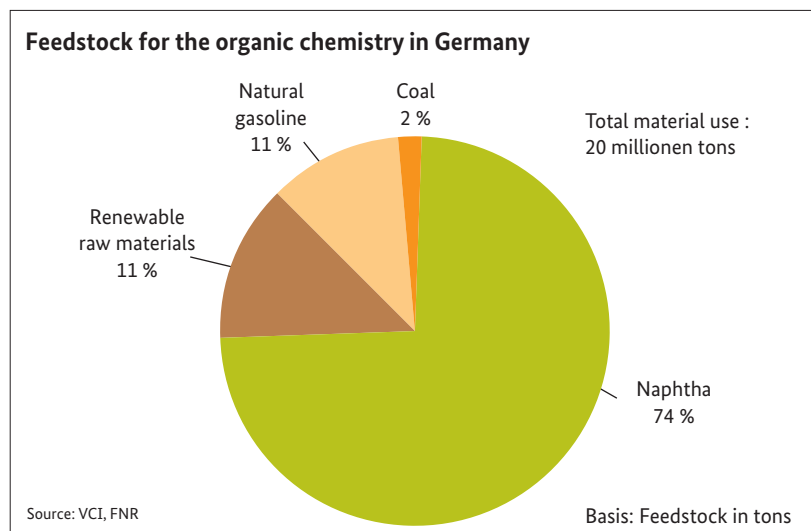

Fig. 2:  
Raw materials mix used for the production of organic chemicals (Germany 2017), total quantity: approx. 20m metric tons (Source: VCI)



on the part of the oil-producing nations, the price had fallen to US\$ 30 per barrel by the beginning of 2016. At the time of writing, the price has risen again to around US\$ 50, partly in response to a consensus among OPEC member countries to reduce output levels of crude oil. Over the long-term however, it seems clear that prices for fossil raw materials will increase. In an attempt to reduce the quantities of fossil resources used, and so become less dependent on raw material suppliers, and to avoid the planning uncertainty described above, the chemical industry is currently evaluating the possibility of using carbon dioxide as a source of carbon. After all, CO<sub>2</sub> is produced in large quantities in power plants and industrial facilities, as well as in biogas plants, breweries and waste incinerators. And so the question automatically arises: **Can CO<sub>2</sub> replace crude oil in the future?**

#### 1.1.1.1.2 Climate change and political goals

Another reason for utilising CO<sub>2</sub> as a raw material for chemical synthesis is anthropogenic climate change. Climate scientists on the Intergovernmental Panel on Climate Change (IPCC) not only agree, but they have also convinced the global community that current changes to the Earth's climate are principally attributable to emissions of CO<sub>2</sub> and other greenhouse gases into the atmosphere. Since the beginning of the Industrial Revolution, the concentration of CO<sub>2</sub> in the Earth's atmosphere has risen from around 280 ppm to 400 ppm causing significant changes to the climate with devastating consequences for many regions of the planet. In order to counter further climate change and to maintain current living conditions for humankind, it is necessary to drastically reduce emissions of CO<sub>2</sub> and other greenhouse gases. The major goal is to restrict any increase in the global average temperature to less than 2 °C. In December 2015 at the COP21 (UN Climate Conference – Conference of the Parties) in Paris, the 195 member countries of

Post-COP21 strategies



Fig. 3:  
The consequences of climate change: Increased levels of drought, flooding and storms (Source: Thinkstock)

the UNFCCC (United Nations Framework Convention on Climate Change) pledged to take significant steps to achieve the two-degree climate target by the 2100 horizon. The agreement came into force on 14 November 2016. The measures to be introduced will be flexible and will take account of the circumstances of the different countries.<sup>111</sup>

Germany has published its Climate Action Plan 2050 and has committed itself to reducing greenhouse gas emissions by 80–95% of 1990 levels by the year 2050, with interim targets set for the years 2020, 2030 and 2040. This ambitious goal can only be achieved through drastic cuts in the use of conventional fossil energy resources.

#### The signatories to the UN Climate Conference agreed

- to the long-term goal of limiting the increase in global average temperature to well below 2 °C above pre-industrial levels
- to the goal of limiting the temperature rise to 1.5 °C, as this would significantly reduce the risks and impacts associated with climate change
- on the need to ensure that global emissions peak as soon as possible, while recognising that this will take longer to achieve for developing countries
- to undertake rapid reductions thereafter in accordance with the best available science

Source: European Commission  
[https://ec.europa.eu/clima/policies/international/negotiations/paris\\_de](https://ec.europa.eu/clima/policies/international/negotiations/paris_de), retrieved 25.05.2017 e

Making use of CO<sub>2</sub> as a chemical feedstock can make a significant contribution to reducing CO<sub>2</sub> emissions in a number of industrial sectors provided that certain conditions are met, particularly the use of renewable sources of energy to drive the processes involved. It must, however, be emphasised that CO<sub>2</sub> utilisation represents only a small portion of the total quantities of CO<sub>2</sub> currently being emitted into the atmosphere and that using CO<sub>2</sub> as a chemical feedstock cannot be the sole solution to the greenhouse gas emissions problem. CO<sub>2</sub> utilisation essentially offers a means of optimising the carbon footprint of individual industrial processes. This situation is analogous to that in which a broad range of individual energy efficiency measures can, when taken together, produce a significant reduction in CO<sub>2</sub> emissions. There is no one single solution to the problem of climate change. A whole raft of different measures need to be implemented in order to mitigate emissions of greenhouse gases into the atmosphere in accordance with the objectives of international climate action plans.

The greatest contribution to reducing greenhouse gas emissions must come from the energy sector and renewable energy sources will therefore continue to play a significant role in this regard. The transport sector will also need to change, with partial electrification in conjunction with the transition to a renewable sources of energy representing a major step in the right direction. Expanding the role played by renewable sources of energy brings with it the

need for new energy storage concepts that will be able to compensate for the weather-dependent and time-dependent fluctuations in electric power derived from wind and solar sources. CO<sub>2</sub> utilisation can help to couple these different sectors. (For more information, please refer to the sections dealing with chemical energy storage systems.)

### 1.1.1.2 CO<sub>2</sub> utilisation: Concepts and product portfolio

The portfolio of products and services relating to CO<sub>2</sub> utilisation is very complex. On the one hand, CO<sub>2</sub> can be used directly, for example as an inert gas in packaging. But it can also undergo chemical conversion in which it is transformed into other materials via chemical synthesis or biotechnological processes. CO<sub>2</sub> is suitable for use as a raw material for the production of speciality chemicals or primary chemical products (often referred to as bulk chemicals), but it can also be used in manufacturing products ranging from special plastics to fuels or construction materials. The specific benefits and the motivation for utilising CO<sub>2</sub> varies from application to application and from process to process. Making physical use of CO<sub>2</sub> as a gas is already well known and there are already a large number of established processes in which CO<sub>2</sub> is used in this way on the industrial scale. However, making use of CO<sub>2</sub> in this manner does not necessarily lead to any reduction in CO<sub>2</sub> emissions. Although applications that exploit the physical properties of CO<sub>2</sub> do not require large amounts of energy, the CO<sub>2</sub> is immediately emitted after use and the potential emissions savings that can be achieved via these physical applications are notably limited. Some of the physical properties of CO<sub>2</sub> make it particularly well suited for certain applications. Reducing consumption of fossil raw materials or mitigating CO<sub>2</sub> emissions are not usually the motivation behind applications that exploit the physical properties of CO<sub>2</sub>. However, if CO<sub>2</sub> has to be 'produced' especially for such applications, it is worth examining whether use can be made of more sustainable sources of CO<sub>2</sub> that already exist.

The situation is quite different in the case of the chemical utilisation of CO<sub>2</sub>. In this case, the CO<sub>2</sub> undergoes chemical conversion, reacting with other molecules to yield useful products. It is important to note, however, that in most situations a substantial amount of energy is necessary in order to chemically convert the CO<sub>2</sub>. For environmental reasons, it is essential that the energy used in these chemical conversion processes comes from renewable sources. Carbon dioxide is also a relatively chemically inert molecule and therefore needs to be activated by means of catalysts, which can be thought of as a kind of chemical 'marriage broker'. The objective is to achieve CO<sub>2</sub> fixation in usable higher value products, thus promoting not only environmental sustainability but economic benefits as well. The period of CO<sub>2</sub> fixation corresponds to the life cycle of the product. Extreme cases are transport



fuels, which immediately rerelease the CO<sub>2</sub> on combustion. If it proves possible to recover CO<sub>2</sub> from the atmosphere and to use it for fuel production, the transport fuels of the future would be substantially more climate-friendly than those used at present. If the CO<sub>2</sub> used in the production of transport fuels is sourced from industrial processes, the overall result is a reduction in the consumption of fossil resources. In this case, CO<sub>2</sub> serves to broaden the raw materials base of the chemical industry and CO<sub>2</sub> emissions are reduced as conventional fossil-based fuels do not need to be used. By analysing the carbon foot-print of competing processes, it should, in general, be possible to identify the process that generates the smallest additional quantities of CO<sub>2</sub> emissions and that may even yield a carbon footprint smaller than the corresponding reference process. Ultimately, the question whether or not it makes economic as well as environmental sense to utilise CO<sub>2</sub> as a chemical feedstock must be answered separately for each individual process at each individual production site.

There are also a large number of biotechnological pathways in which CO<sub>2</sub> is used as a starting material. In these biotech applications, microorganisms are used either to bind the CO<sub>2</sub> in biomass or to convert it to higher value products. As is the case with the chemical utilisation of CO<sub>2</sub>, the sustainability of the overall biotech process must be assessed. It is also possible to utilise CO<sub>2</sub> biologically: natural processes such as photosynthesis can be exploited to bind CO<sub>2</sub> within biomass, such as algae.

Experts in the CO<sub>2</sub> utilisation field currently predict that by 2030 the first CO<sub>2</sub>-based consumer products, such as mattresses, will be marketed, that construction materials produced using CO<sub>2</sub> will be competing with conventionally produced materials, and that CO<sub>2</sub>-based fuels will be available. According to this vision of the future, it is predicted that a CO<sub>2</sub>-based economy will be fully established by 2050.

Fig. 4:  
Pathways for transformation  
and usage of CO<sub>2</sub>  
(Source: compiled by the authors)

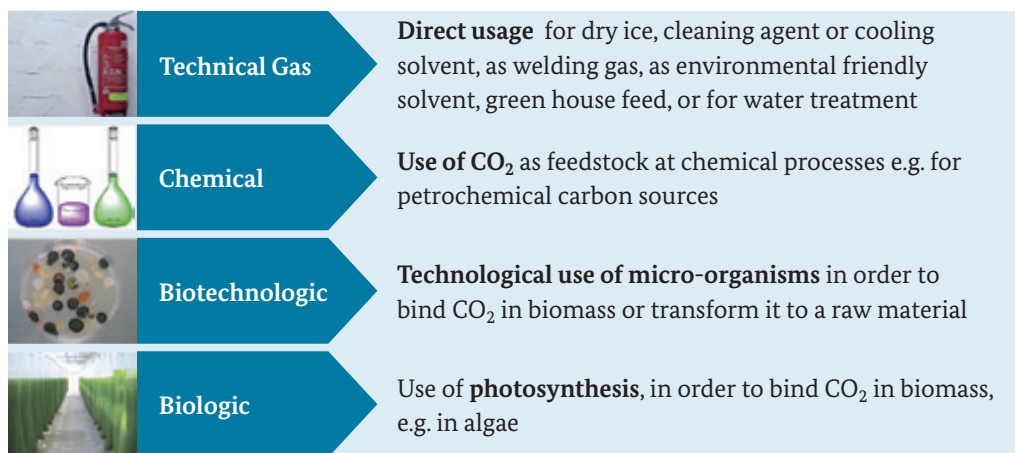

## 1.1.2 CO<sub>2</sub> utilisation

The utilisation of CO<sub>2</sub> as a material resource can be divided initially into the areas physical use and chemical use. The physical use of CO<sub>2</sub> as an industrial gas is already well-established in many areas. The chemical utilisation of CO<sub>2</sub> is not new but the opportunity now exists to exploit novel synthetic routes that allow the molecule to be incorporated sustainably in both existing and new value generating production chains. In this section, we provide an overview of the various areas in which CO<sub>2</sub> can be utilised.

### Where is CO<sub>2</sub> already used?

- Sparkling and refreshing – CO<sub>2</sub> is used in the beverages industry to create carbonated drinks.
- Putting out fires – CO<sub>2</sub> is used in fire extinguishers both as a propellant and an extinguishing agent.
- Clean and fresh – CO<sub>2</sub> is used in the textiles sector as a cleaning agent.
- Keeping a clear head – Climate change and CO<sub>2</sub> emissions have been giving people a headache for years. But CO<sub>2</sub> can also help to relieve headaches, as it is used in the manufacture of aspirin.
- Well packaged – CO<sub>2</sub> is used as a protective inert gas in the food industry, where it helps to extend the shelf-life of food, such as meat.
- Promoting growth – CO<sub>2</sub> and ammonia have been used in fertiliser production since the 19th century.
- Ice cold – CO<sub>2</sub> is used as a refrigerant in a wide range of technical processes.

### 1.1.2.1 The physical use of CO<sub>2</sub>

The physical utilisation of carbon dioxide refers to those applications in which the whole molecule is used directly without undergoing any chemical conversion. CO<sub>2</sub> is selected for these applications because it has a number of useful physical properties: it is non-flammable, non-toxic and relatively inert, it has an easily accessible supercritical regime and, when compared to other refrigerants, it has a comparatively low greenhouse gas potential. CO<sub>2</sub> is therefore used as a refrigerant in a wide variety of processes. In the food industry, it is used as an inert protective gas to extend the shelf-life of foods, it is used in the beverages industry to produce carbonated drinks and to remove caffeine from coffee. CO<sub>2</sub> is also used both as a propellant and as an extinguishing agent in fire extinguishers, as a cleaning agent in the textile industry, as an extraction agent and for impregnating wood.

The physical utilisation of CO<sub>2</sub> also covers Enhanced Oil/Gas Recovery (EOR, EGR) procedures. Enhanced oil or gas recovery involves injecting CO<sub>2</sub> into natural gas or oil fields, which raises the pressure in the reservoir, thus increasing the amount of gas or oil that can be extracted from the field. As a result of EOR and EGR activities, about 20 million metric tons of CO<sub>2</sub> are stored below ground annually. EOR and EGR are primarily a means of improving oil and gas extraction making extraction from a particular oil or gas field profitable for longer.

These procedures were not introduced in order to promote sustainability. However such pathways must be taken into account whenever CO<sub>2</sub> is generated in an industrial process and cannot be utilised in any other way.

CO<sub>2</sub> is used in its solid, liquid and gaseous forms. Making direct physical use CO<sub>2</sub> is not an energy intensive process. However, with the exception of EOR/EGR, these applications result in the direct release of CO<sub>2</sub> back into the atmosphere. These applications do not therefore result in a reduction in CO<sub>2</sub> emissions.

### 1.1.2.2 The chemical use of CO<sub>2</sub>

The chemical and biotechnological utilisation of CO<sub>2</sub> involves using it as a reactant in chemical and biochemical reactions. The use of CO<sub>2</sub> as a building block in chemical reactions is not new and a number of long-established processes based on this concept already exist. The spectrum of products in which CO<sub>2</sub> can be used as a reactant or feedstock ranges from basic chemicals to polymers, special chemicals and synthetic fuels. Dividing CO<sub>2</sub>-based products into chemicals and fuels is not always clear cut, as some substances, such as methanol, are clearly important in both categories. Figure X shows a number of the many products fabricated via CO<sub>2</sub>-based syntheses.

#### 1.1.2.2.1 Major commercial processes

At present, around 110 million metric tons of CO<sub>2</sub> are utilised as chemical feedstock. The syntheses and products described below represent the most important ways in which CO<sub>2</sub> is utilised as a chemical building block.

##### 1.1.2.2.1.1 Synthesis of urea

In the urea synthesis reaction, CO<sub>2</sub> reacts with ammonia to form **urea**. Urea can be used as a nitrogen fertiliser or as a starting material in the chemical industry for the production of other chemical products, such as urea resins. Urea resins are useful as adhesives and for their impregnation and insulation properties. Annual production levels for urea are around 150 million metric tons, for which about 110 million tons of CO<sub>2</sub> are utilised. Ammonia and urea production facilities are typically integrated so that the CO<sub>2</sub> for the

---

In terms of quantities produced, urea production is the most important commercial CCU operation

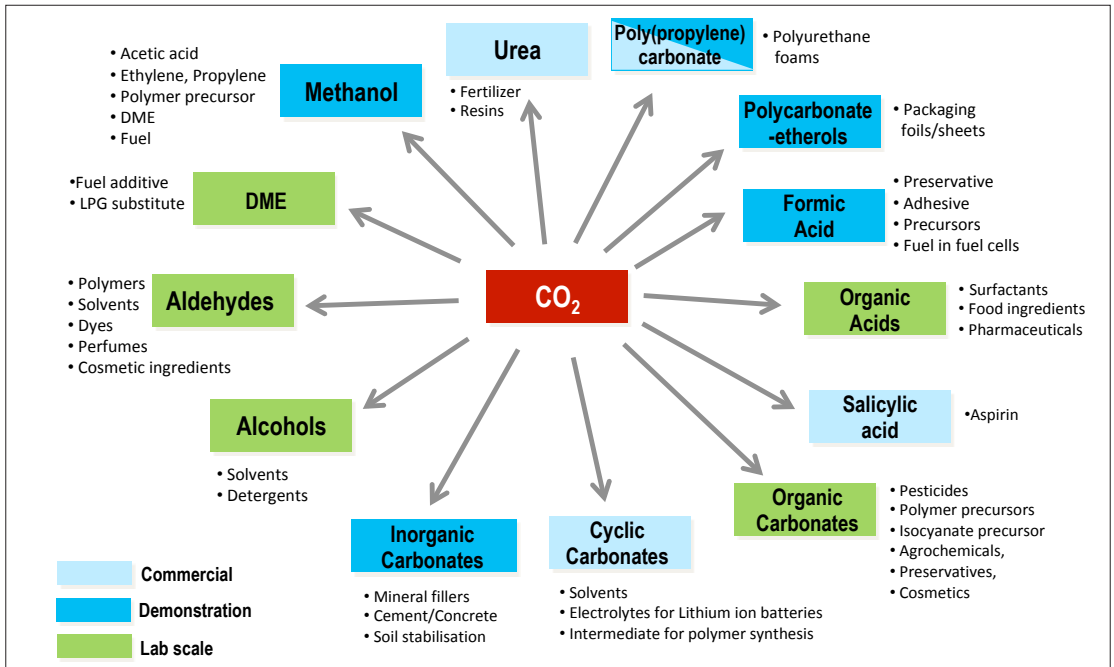

urea synthesis is taken directly from the synthesis gas unit, which is part of the ammonia production process. The urea synthesis reaction is shown in Equation (1):

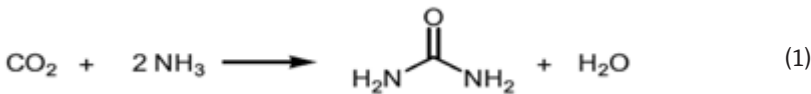

#### 1.1.2.2.1.2 The Kolbe-Schmitt synthesis of salicylic acid

Another example of an established process involving the chemical utilisation of CO<sub>2</sub> is the **Kolbe-Schmitt reaction** (also referred to as the Kolbe process) in which sodium phenoxide and CO<sub>2</sub> react as shown in Equation (2) to form salicylic acid. Salicylic acid can then be reacted further to produce dye-stuffs and odorous compounds. It is also a key component in the manufacture of the active ingredient acetylsalicylic acid, which is more commonly known as Aspirin<sup>TM</sup>. Annual production of salicylic acid is around 70,000 metric tons, for which 25,000 metric tons of CO<sub>2</sub> are required.<sup>vi</sup>

The Kolbe Schmitt reaction to form salicylic acid:

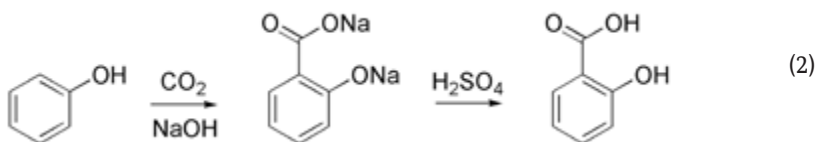
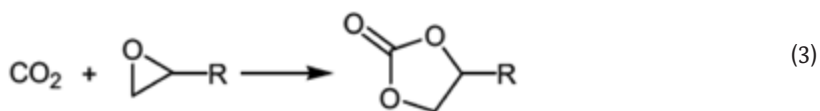

Fig. 5: Products from CO<sub>2</sub>-based syntheses

### 1.1.2.2.1.3 Cyclic carbonates

Another established process is the production of cyclic carbonates by reacting epoxides with CO<sub>2</sub> as shown in Equation (3). Annual production levels are about 80,000 metric tons, for which 40,000 tons of CO<sub>2</sub> are required. Cyclic carbonates are used as solvents, electrolytes for lithium-ion batteries and as intermediates in a variety of polymer syntheses. The reaction below illustrates the formation of a cyclic carbonate from an epoxide:



### 1.1.2.2.1.3 Methanol synthesis

Another industrial process in which CO<sub>2</sub> is used as a reactant is when it is added in small quantities to hydrogen-rich synthesis gas to synthesise methanol. Global production of methanol is around 80 million metric tons per annum, for which approximately 2 million tons of CO<sub>2</sub> are used. The direct synthesis of methanol from CO<sub>2</sub> and hydrogen described in Equation (4) has not yet been implemented on a major industrial scale, but is already being used in a number of smaller commercial plants (see Section 1.2.2.2).



### 1.1.2.2.2 Processes currently in the demonstration phase and commercial facilities in the process-launch or expansion phase

A number of processes in which CO<sub>2</sub> is used as a chemical building block are currently poised for introduction into the market. Demonstration plants are already in operation for the products and processes described below, and a number are now commercially available on the market.

#### 1.1.2.2.2.1 Polymers

Expressed simply, polymers are chemical substances composed of a large number of repeating units of the same groups of atoms that are arranged such that they form linear or branched chains. Synthetic polymers are usually referred to as plastics.

The manufacture of plastics involves linking together the chemical building blocks (the 'monomers') that make up the polymer. In the case of CO<sub>2</sub>, it can either be used as a monomer and be directly incorporated into the polymer chain, or the polymer can be composed of monomers that were previously synthesised using CO<sub>2</sub>. The chemical industry hopes that CO<sub>2</sub>-based plastics will deliver innovative new products exhibiting novel or improved material

properties. This is because the properties shown by a plastic (hard or soft, brittle or elastic, foamable or non-foamable) can vary significantly depending on the choice of starting materials. This variability in material properties is what makes plastics economically so attractive. A further incentive for utilising  $\text{CO}_2$  in the synthesis of plastics is that the production process may be more environmentally friendly with lower levels of process-related  $\text{CO}_2$  emissions or reduced consumption of fossil resources. Evaluating whether or not this is the case for a given  $\text{CO}_2$ -based process requires a life cycle assessment to be carried out and the results must then be compared with those for an established conventional process that uses purely fossil-based raw materials.

The polymer reaction that produces polyether carbonate polyols – components used in the manufacture of the ubiquitous mass-produced plastic polyurethane – was developed in the ‘Dream Reactions’ project, itself part of the research and development programme ‘Technologies for Sustainability and Climate Protection – Chemical Processes and Use of  $\text{CO}_2$ ’ funded by the German Federal Ministry of Education and Research (BMBF). The ‘Dream Reactions’ project involved fundamental studies aimed at understanding the catalytic production of monomeric and polymeric carbonates using  $\text{CO}_2$  as a synthetic building block. The goal was to synthesise polyether carbonate polyols from  $\text{CO}_2$  and epoxides. Polyols are a group of organic compounds that contain the hydroxyl group ( $-\text{OH}$ ) as a repeat structural element. The project partners, coordinated by COVESTRO, succeeded in manufacturing polyether carbonate polyols with outstanding material properties via a catalytic reaction that utilised  $\text{CO}_2$ . A life cycle assessment conducted by RWTH



Fig. 6:  
Completed Mini Plant for the  
production of  $\text{CO}_2$ -containing  
polyols

Aachen University showed that the carbon footprint of the overall process was significantly lower than that of the reference process. A key factor behind the reduced carbon footprint was the partial replacement of the fossil-based epoxides by CO<sub>2</sub>.

A pilot plant was built and operated in Leverkusen as part of a second project 'Dream Production'. Once the pilot plant's test phase had been completed successfully, COVESTRO funded its own commercial plant in Dormagen, which went on stream in 2016. The product is a novel polyol containing about 20 % CO<sub>2</sub>. The polyol is a central component for synthesising a polyurethane foam that will be used in the manufacture of foam mattresses. The commercial plant in Dormagen has an annual production capacity of 5000 metric tons of polyether carbonate polyol. The CO<sub>2</sub> used in the production of the polyol comes from an ammonia-producing plant operated on the same site by the company Ineos.

But COVESTRO is not the only company currently implementing polymer production projects: in the USA, NOVOMER is operating a commercial plant for polycarbonates and polyols; in Japan between 65 and 260 kilotons of bisphenol-A polycarbonate is being produced annually in five commercial plants; and in China, Jinlong-Cas Chemical Co. operates a facility that produces 10,000 metric tons of poly(propylene carbonate) per year. Potential global demand for poly(propylene carbonate) has been estimated to be around 50,000 metric tons annually.

#### 1.1.2.2.2 Synthetic fuels

The production of synthetic fuels is a very promising area for the chemical utilisation of CO<sub>2</sub>. If it was possible to manufacture all liquid fuels from CO<sub>2</sub>, their production would require **3–5 billion metric tons of CO<sub>2</sub>** globally per year depending on actual future levels of fuel demand. Another particularly appealing feature of CO<sub>2</sub>-based fuels is that they can be introduced into an existing market infrastructure. As already mentioned, synthetic fuels can also be used as chemical systems for storing excess electricity from renewable energy sources, thus providing the necessary temporary and spatial flexibility to manage energy supply bottlenecks. Demonstration units that use CO<sub>2</sub> as a chemical building block in the production of synthetic diesel, synthetic petrol, kerosene, methane and methanol are already in existence.

At present, the processes that play a key role in the production of CO<sub>2</sub>-based liquid fuels are hydrogen production by **electrolysis**, the generation of synthesis gas (syngas) via the **reverse watergas shift reaction (RWGS)** and subsequent chemical conversion processes, such as the Fischer-Tropsch reaction. Hydrogen (H<sub>2</sub>) is an essential component in the production of synthetic fuels, as it is needed to chemically reduce the CO<sub>2</sub>. In the electrolysis of wa-



ter, the water is split into H<sub>2</sub> and oxygen (O<sub>2</sub>) (Equation (x)). **Electrolysis** requires substantial amounts of energy and for reasons of sustainability this electrical energy must be generated from renewable sources. A number of process design concepts propose making use of the fluctuating levels of excess electricity from renewable sources.

**Electrolysis:  $3 \text{ H}_2\text{O} + e^- \rightarrow 3 \text{ H}_2 + 1,5 \text{ O}_2$  (289.5 kJ/Mol)**

H<sub>2</sub> and CO<sub>2</sub> can be converted to produce a mixture of the gases CO and H<sub>2</sub> (syngas) via the **reverse water gas shift reaction (RWGS)**, with water produced as a by-product.

**Reverse Water-gas-shift reaction:  $\text{CO}_2 + 3 \text{ H}_2 \leftrightarrow \text{CO} + 2 \text{ H}_2 + \text{H}_2\text{O}$**

The term Fischer-Tropsch synthesis (**FT synthesis**) refers to a number of reactions in which synthesis gas from carbonaceous resources (coal, natural gas, crude oil and biomass) is converted into hydrocarbons of different chain lengths. F-T synthesis is the final stage in the chain of processes utilising CO<sub>2</sub> in the production of synthetic fuels. The process, which was discovered by Franz Fischer and Hans Tropsch in 1925, was used principally to convert coal into liquid products. It was deployed in the Second World War in Germany to maintain the supply of fuel. At a time in which natural gas is becoming increasingly scarce and more expensive, the FT process offers a means of converting synthesis gas to petrol, diesel, kerosene and other hydrocarbon products for the chemical industry. The FT reaction is shown schematically in Equation (x):

**FT-synthesis:  $n \text{ CO} + 2n \text{ H}_2 \rightarrow \text{-(CH}_2\text{)}_n\text{-} + n \text{ H}_2\text{O}$  (x)**

The Dresden-based company *sunfire* is using this synthetic route to produce fuels for cars, ships and planes as well as other chemicals from CO<sub>2</sub>, water and renewable energy. As part of a BMBF-funded project of the same name, sunfire has built a pilot plant in Dresden for the production of synthetic fuels. The heat generated by the Fischer-Tropsch reaction is used to generate steam that is then split in a particularly efficient high-temperature electrolysis unit to yield hydrogen – an approach that significantly boosts the efficiency of the overall process. It is also worth noting that the steam electrolysis unit is reversible and can be operated as a fuel cell, i.e. if there is an increase in demand for electricity, the hydrogen produced previously can be recombined with oxygen to generate electricity. The pilot plant began operating in 2014 and has a capacity of around 1 barrel (159 litres) of fuel per day.

Fischer-Tropsch Synthesis:  
Fuels for the future using  
technology from the past



Known processes working together in a new way:

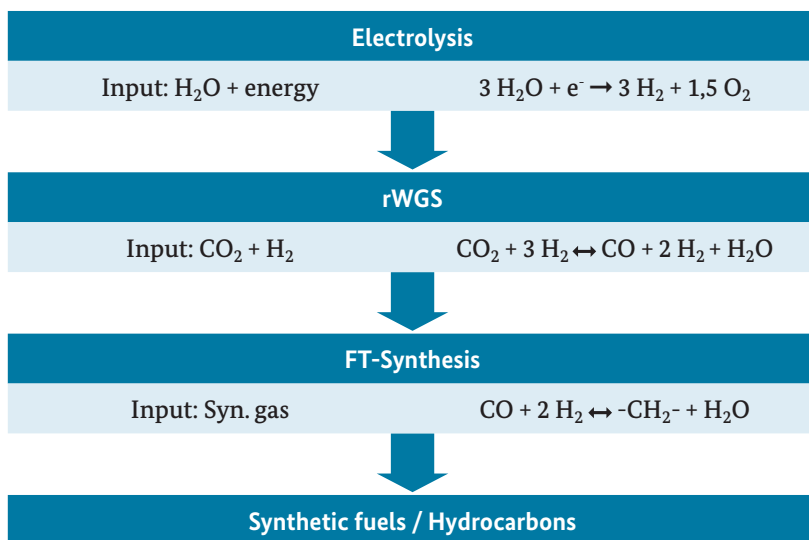

In the **methanation reaction** (also known as the **Sabatier process**), methane can be generated from CO<sub>2</sub> and hydrogen in accordance with the reaction shown in Equation (y):



In 2013, the car manufacturer Audi began operating a **demonstration plant** comprising a 6-MW electrolysis unit and methanation plant in Werlte. In the demonstration facility, a renewables-powered PEM-electrolysis unit is used to generate hydrogen which is then converted with CO<sub>2</sub> from a biogas plant to produce methane. Audi is currently testing the possibility of supplying 'Audi e-gas' to cars or other gas consumers such as domestic households. The plant feeds around 1000 metric tons of gas into the gas network each year. According to Audi, approximately 2800 metric tons of CO<sub>2</sub> are utilised annually.

Methane and methanol can be used as a source of energy or as a raw material in the chemical industry

Methane and methanol can be used as a source of energy or as a raw material in the chemical industry

**Methanol** is not only an important feedstock in the chemical industry, it can also be used directly as a fuel or for the synthesis of fuel components. Currently, the European Union allows the addition of up to 3% of methanol to petrol. Methanol is also a precursor in the production of important chemicals such as methyl tert-butyl ether (MTBE), dimethyl carbonate (DMC) and dimethyl ether (DME). MTBE is added to petrol as an anti-knock agent, DMC can be used as an alternative fuel additive and DME may be used in future as an alternative to diesel fuel.

Dimethyl carbonate (DMC) can be produced from methanol and CO<sub>2</sub> with high yields. Dimethyl ether (DME) can also be produced directly from H<sub>2</sub> and CO<sub>2</sub>.

While methanol is typically synthesised from syngas, a mixture of carbon monoxide and hydrogen, it can also be generated from the reaction of carbon dioxide and hydrogen (see Equation (z)):



The world's largest Power-to Methanol plant has been built by Carbon Recycling International in Iceland. The plant consumes around 5500 metric tons of CO<sub>2</sub> each year in the methanol production process. The plant is powered using electricity from hydrothermal or geothermal sources in Iceland. Electricity is used to generate H<sub>2</sub>, which is then converted catalytically with CO<sub>2</sub> to produce methanol. The CO<sub>2</sub> feedstock is captured from the flue gases of a geothermal facility located on the same site as the power-to-methanol plant.

#### 1.1.2.2.3 Formic acid

The hydrogenation of carbon dioxide leads initially to the formation of formic acid (HCO<sub>2</sub>H). Formic acid is an industrial chemical that is used for neutralising alkaline reaction mixtures, as a preservative in the food industry, for tanning in the leather industry, and for bonding polyamide in the plastics industry. There is also the possibility of generating hydrogen from formic acid for use in fuel cells. Small-scale demonstration plants with an annual production capacity of up to 350 kg of formic acid that use CO<sub>2</sub> as a chemical feed-stock have already been tested successfully. Mention should also be made of the 'Energy-efficient Electrochemistry in Microreactor 2.0' project that is being coordinated by the University of Stuttgart. The goal of this applied research project is to develop an energy-efficient electrochemical process for manufacturing formic acid from CO<sub>2</sub> emission sources. Electrochemical conversion of CO<sub>2</sub> into formic acid will take place in microreactors and by making use of renewable energy sources, such as photovoltaic or wind power, the process can function as an energy storage system. There are plans to evaluate the technology at a later date in order to determine how much CO<sub>2</sub> can be converted and whether or not the process represents an economically viable option for industrial companies.

#### 1.1.2.2.4 Inorganic carbonates (minerals/construction materials)

The construction industry is another area offering a number of promising opportunities for using CO<sub>2</sub> as a raw material. Through its reaction with silicates and mineral oxides, CO<sub>2</sub> can be incorporated in inorganic carbonates, which can be used, for example, in construction materials like cement, which is the binder used in concrete. This type of CO<sub>2</sub> utilisation represents

One goal for the future is to construct an entire building with a negative carbon foot-print by using cement from mineralised waste and CO<sub>2</sub> captured from industrial sources.

a genuine carbon sink, as the carbonates that form are stable over geological timescales. The process actually occurs very slowly in nature and is responsible for binding many millions of tons of CO<sub>2</sub> each year. For industrial applications, the process (see Equation (xx)) needs to be accelerated significantly before it can be regarded as viable.

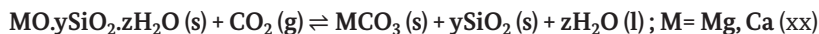

When computing the carbon footprint for the overall process the fact that the process of mineralisation is very energy intensive (e.g. milling, high-temperature reactions) must also be taken into account. Nevertheless, this application has the potential for utilising significant quantities of CO<sub>2</sub>, reflecting the fact that cement is one of the world's most commonly used materials. The cement industry is very interested in reducing its own carbon emission levels, as 5 % of global CO<sub>2</sub> emissions come from the cement industry.

The British company Carbon8 treats industrial waste with CO<sub>2</sub> to produce minerals that can be used as aggregate for concrete or as building materials. The patented Accelerated Carbonation Technology (ACT) offers a quick and easy means of processing solid waste residues. The CO<sub>2</sub>-based product can be used as a secondary aggregate, engineering fill or for construction materials with specialist properties. The Recoval company in Belgium also uses CO<sub>2</sub> to produce aggregates that can be used, for example, in road construction. Companies such as Heidelberg Cement, Shell, Lafarge, Saint Gobain and ArcelorMittal are also currently researching how CO<sub>2</sub> can be incorporated in construction materials. There is also interest in implementing such projects in Germany.

#### 1.1.2.2.3 Basic research into CO<sub>2</sub> utilisation

Considerable basic research still needs to be carried out if CO<sub>2</sub> utilisation is to become established in all industrial and geographical areas. This is true for all aspects and all types of CO<sub>2</sub> utilisation. In the following section we highlight the important role played by catalysis.

##### 1.1.2.2.3.1 Catalysis

As already mentioned, the greatest barrier to industrial CO<sub>2</sub> utilisation is the stability and relative inertness of the molecule. As part of the basic research work being undertaken in this field, catalysis has a particularly important role to play as it is one way of encouraging CO<sub>2</sub> to undergo chemical reactions. Understanding the reaction mechanisms involved requires a fundamental understanding of catalytic processes. There are a large variety of catalytic systems that can potentially transform CO<sub>2</sub> into a promising reactant for the synthesis of chemical products in the chemical and allied industries. In **homogeneous catalysis**, the reactants and the catalyst are in the

Catalysis is a key element  
in achieving efficient  
CO<sub>2</sub> utilisation

same phase, typically in solution. Homogeneous catalysis is used, for example, in the hydrogenation of CO<sub>2</sub> and the dehydrogenation of formic acid. In **heterogeneous catalytic systems**, the reactants and the catalyst are in different phases, with the catalyst typically present in the form of a solid. The advantage of heterogeneous catalysis, is that at the end of the reaction it is easier to separate the catalyst from the reactants and products. Heterogeneous catalysts are significant factors in the economic success of numerous industrial processes that produce basic chemicals, such as the Haber-Bosch process for synthesising ammonia, or methanol production. Heterogeneous catalysis is also integral to Fischer-Tropsch syntheses. **Electrocatalysis** is a subset of heterogeneous catalysis in which the electrocatalyst acts to lower the activation energy of electrochemical reactions. In the case electrochemical processes relating to CO<sub>2</sub> utilisation, much of the focus of current research is on studying the electrolysis of water to generate hydrogen or the joint electrolysis of water and CO<sub>2</sub>, examining, for example, catalysts that are able to extend the service lives of fuel cells. In **photocatalysis**, a chemical reaction is initiated through the action of light. Making efficient use of sunlight in order to overcome the relative inertness of CO<sub>2</sub> would represent an important breakthrough in the field of chemical energy storage. A coupled system in which hydrogen is generated photocatalytically from water and then reacts with CO<sub>2</sub> would correspond to a technical implementation of the natural process of photosynthesis and would enable the direct production of 'solar fuels' or formic acid from renewable sources of energy. However, the field of photocatalysis is still very much an area in which basic research needs to be carried out. The most important objective of the research is to significantly improve reaction yields. Another area is that of **biocatalysis** in which enzymes or microorganisms (whole cells) are used to convert, in this case, CO<sub>2</sub> to useful chemical products. A number of microbes are able to metabolise CO<sub>2</sub> and transform it into new substances. In order to do this, the microorganisms need energy, sunlight, heat or even electric current. The latter case is an example of **microbial electrosynthesis** in which researchers are attempting to use electroactive microorganisms to produce chemicals, such as acetate, ethanol, butyrate, butanol, acetone or methane. There are also plans to combine green electricity and organisms able to metabolise CO<sub>2</sub> to produce bioplastics. The 'BioElectroPlast' project, which is part of the BMBF-funded research and development programme 'CO<sub>2</sub>Plus', is looking to achieve this very goal.

Another area of research aimed at positively influencing the function of catalysts, or possibly even replacing them, is that of non-thermal plasmas. A non-thermal plasma is a mixture of particles that contains charged components (ions and electrons) and in which there are significant differences in the temperatures of the different types of particles. The idea is to study these plasmas so as to identify new synthetic pathways that are more direct than

those associated with the 'usual' catalytic CO<sub>2</sub> hydrogenation mechanism. The idea is that plasma chemistry would facilitate the efficient activation of CO<sub>2</sub> at room temperature and atmospheric pressure. The unusual chemical properties of non-thermal plasmas are due to the high temperature of the electrons in the plasma environment. As plasma-based applications can influence both homogeneous and heterogeneous catalytic systems, impacting electrochemistry, photochemistry and radiation chemistry, non-thermal plasmas provide a large number of new avenues for catalyst researchers to explore. As plasma applications require the input of large amounts of energy, renewable sources of energy will be needed if these processes are to be sustainable.

### 1.1.2.3 Summary

The use of carbon dioxide as a chemical feedstock is a broad and varied field in which the combustion product CO<sub>2</sub> can be used to manufacture fuels, plastics and construction materials. If CO<sub>2</sub> is to be utilised in a meaningful way, chemists, engineers and biotechnologists must work together with environmental analysts, economists and policymakers to identify those pathways that are worth exploring, and then conduct the necessary research, implement the findings and create the requisite policy and regulatory framework that will enable CO<sub>2</sub> to be incorporated successfully into the value chain. Exploiting the potential of CO<sub>2</sub> utilisation to the full will only be possible through a concerted effort by all stakeholders. From a technical and engineering perspective, innovation can boost process efficiency and new catalysts can help to reduce the energy requirements associated with using CO<sub>2</sub> as a chemical building block. But the free market also raises barriers to CO<sub>2</sub> utilisation, as the relatively low price of fossil-based raw materials currently means that CO<sub>2</sub>-based products, like plastics and synthetic fuels, will, for the time being at least, remain niche products. If this situation is to change, policymakers will need to create a statutory environment that ensures that processes in which CO<sub>2</sub> is used as a chemical feedstock can compete with conventional fossil-based production processes. This could be achieved by adjusting the EU Emissions Trading System (EU ETS) and through amendments to the relevant EU directives for raw materials, fuels and waste. Another conceivable approach would be to create incentives, such as tax reductions for CO<sub>2</sub> utilisation pathways, that would encourage industry to reduce its consumption of fossil raw materials.

If we are to achieve a broader raw materials base for process industries, manufacture the fuels of the future, and construct buildings and roads using carbon-neutral materials, continued investment in research and development in this field is essential.

## References:

PlasticsEurope Market Research Group

- I Source: VCI - Rohstoffmix der organischen Chemieproduktion [*VCI - Raw Materials Mix in the Production of Organic Chemicals*], <https://www.vci.de/vci/downloads-vci/top-thema/daten-fakten-rohstoffbasis-der-chemischen-industrie-de.pdf>, 2014, retrieved on 25.05.2017
- III Source: European Commission [https://ec.europa.eu/clima/policies/international/negotiations/paris\\_en](https://ec.europa.eu/clima/policies/international/negotiations/paris_en), retrieved on 25.05.2017
- IV Umweltbundesamt [*Federal Environment Agency*], <http://www.umweltbundesamt.de/daten/klimawandel/klimaschutzziele-deutschlands#textpart-1>, retrieved on 25.05.2017
- V Source: European Commission [https://ec.europa.eu/clima/policies/international/negotiations/paris\\_en](https://ec.europa.eu/clima/policies/international/negotiations/paris_en), retrieved on 25.05.2017
- VI Winnacker-Küchler: *Chemische Technik, Prozesse und Produkte [Chemical Engineering, Processes and Products]* [Eds.: R. Dittmeyer, W. Keim, G. Kreysa, A. Oberholz], 5th updated and expanded edition, Wiley-VCH, 2003–2005.

## 1.2 Dream Reactions

### BMBF Project FKZ 033RC0901

Project Coordinator: Dr. Aurel Wolf, Covestro

Project Partner: KIT, Cat Catalytic Center Aachen, TU Dortmund, TU Darmstadt, RWTH Aachen, LIKAT, Max-Planck-Institut für Kolloid- und Grenzflächenforschung

#### 1.2.1 Introduction

The main goals of the BMBF-funded 'Dream Reactions' project were carbon utilisation and carbon fixation (BMBF: German Federal Ministry of Education and Research). The challenge was to make CO<sub>2</sub> readily available as a cost-effective, non-toxic C<sub>1</sub> synthetic building block by developing sustainable processes for synthesising monomeric and polymeric carbonates. The overall project was split into two subprojects: 'Aliphatic Polycarbonates' (PPP) and 'Aromatic Carbonates' (DPC).

The 'Dream Reactions' project was a collaborative undertaking in which Bayer Technology Services GmbH collaborated with a consortium of researchers from the Karlsruhe Institute of Technology, Dortmund Technical University, Darmstadt Technical University, the Max Planck Institute of Colloids and Interfaces, RWTH Aachen University and the Leibniz Institute for Catalysis at the University of Rostock. At the core of the project was the development of novel chemical technologies for utilising CO<sub>2</sub> as an alternative source of carbon. Particular focus was placed on developing innovative and sustainable chemical processes that would offer not only a significant potential for CO<sub>2</sub> fixation but also help to maximise value creation. The development of catalytic systems that enable the resource-efficient and energy-efficient chemical conversion of CO<sub>2</sub> as a C<sub>1</sub> building block is the foundation underlying all of these novel chemical processes. The catalysed synthesis of monomeric and polymeric carbonates from CO<sub>2</sub> was a central object of study within this BMBF-funded project.

The 'Dream Reactions' project pursued two main lines of study. One was the development of highly active and selective catalytic systems for synthesising polyether polycarbonate polyols from carbon dioxide and epoxides. These 'novel' polyols are very interesting compounds and can be used, for example, as building blocks in the production of polyurethanes. The other area of focus was on the catalytic synthesis of monomeric carbonates like dimethyl and diphenyl carbonate. A number of different synthetic routes were examined, including the direct carboxylation of methanol and the direct carbonylation of phenols and other alcohols. The aim was to gain access to these useful intermediates for the phosgene-free synthesis of conventional polycarbonate structures.

## 1.2.2 Project description

The goal is to develop innovative and sustainable chemical processes that exhibit a high CO<sub>2</sub> fixation potential, high energy efficiency and high selectivity, and that also avoid or minimise waste generation. These novel processes will require the development of a **new generation of catalysts** that enable the production of monomeric and polymeric carbonates using carbon dioxide as a C<sub>1</sub> synthetic building block (see Figure 7). The catalysts to be developed will activate the relatively inert CO<sub>2</sub> so that it can be utilised as a valuable feedstock for synthesising carbonates. Another approach that will be explored involves building up the carbonate unit from carbon monoxide (CO) and oxygen. Both reactions can be considered to be dream reactions – hence the name of the project. Up until now, alternative CO/CO<sub>2</sub>-based processes have not been economically viable compared with the established phosgene-based production processes, but new catalysts and new synthetic strategies could well make the development of cost-effective and environmentally friendly processes a realistic option.

The technical complexity of the traditional synthetic route involving phosgene is just one of the drivers behind the development of the alternative processes presented here. The *dream reaction* being targeted in this project **involves the fixation of CO<sub>2</sub>** and the potential to save energy in the

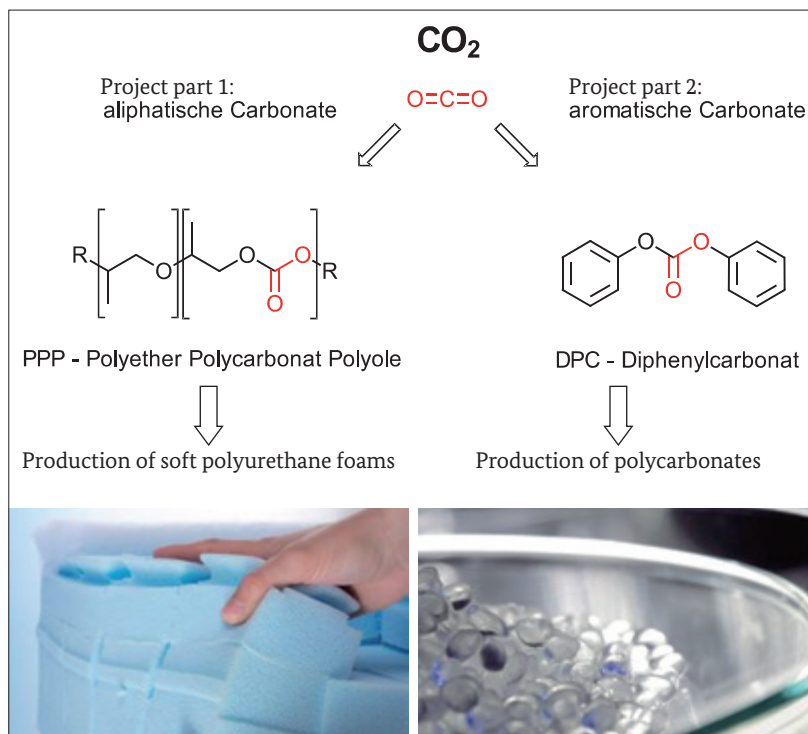

Fig. 7: Carbon dioxide (CO<sub>2</sub>) as a C<sub>1</sub> building block in the synthesis of polyether polycarbonate polyols (PPP), which are used as intermediates in the manufacture of soft polyurethane foams, and of diphenyl carbonate, which is used in the manufacture of polycarbonates.



production process, both of which are of significant interest from an economic and an environmental perspective. This would result in a reduction in the carbon footprint associated with the target compounds when compared with the carbon footprint of established synthetic routes.

In 2013, around 16.4 million metric tons of polyurethane was produced from the industrial conversion of **polyols** with isocyanates. With an annual growth rate of about 5%, polyurethanes are one of the mass products of the global plastics market. Most of the polyols used today are the polyether polyols generated via a ring-opening polymerisation of propylene oxide and ethylene oxide. At present, both of these epoxides are synthesised from fossil resources and their partial substitution by CO<sub>2</sub> in polyether polycarbonate polyols would therefore represent a substantial reduction in the consumption of oil-based resources. The main industrial consumers of polyurethanes are the furniture and wood industry (30 %), the construction sector (25%) and the automotive and transport industry (15 %).

With an annual production volume of 3.3 million metric tons and a market volume of USD 10 billion, **polycarbonates** are one of the world's most important polymer groups. Over the last few years, demand for polycarbonates has grown by 8% annually. The use of significant quantities of CO<sub>2</sub> as a C<sub>1</sub> synthetic building block (potentially several hundreds of thousands of metric tons per year) in this continuously expanding market would send a very clear signal about the use of CO<sub>2</sub> as a chemical feedstock for other synthesis reactions. This would enable CO<sub>2</sub> to become established as an alternative to conventional C<sub>1</sub> building blocks over the long term.

The uses of polycarbonates cover a wide range, from automotive construction (e.g. windows, windscreens, headlamps), electrical components and equipment parts (e.g. computer casings, CDs), medical applications (e.g. pharmaceutical capsules, surgical dressings), agricultural applications (e.g. biodegradable sheeting), packing materials (e.g. bags, packaging fillers, hygiene products) to consumer goods (e.g. bottles).

### 1.2.3 Results

A wide-ranging catalyst screening programme was conducted in the 'Aliphatic Carbonates' subproject. The aim of the screening programme was to discover a suitable catalyst system for activating and converting the reaction of carbon dioxide with propylene oxide to produce polyether polycarbonate polyols. At the beginning of the project, a number of homogenous catalysts were already known that enabled the conversion of epoxides with CO<sub>2</sub> to generate high molecular weight polycarbonates. However, as these

materials do not have any defined functional end groups, they are unsuitable for use in manufacturing polyurethanes. The research effort was focused on transition metal complexes of aluminium, iron, chromium and cobalt for which a library of selected ligands had been synthesised. The best result was achieved with a cobalt(III) catalyst that enabled the conversion of cyclohexene oxide to the corresponding polyether polycarbonate polyol with a yield of 43% and a molar carbonate-to-ether ratio of 49:1. In addition, aluminium complexes with bis(phenoxide) ligands were developed that led to the 100% conversion of cyclohexene oxide, but produced less carbonate than ether product (carbonate-to-ether ratio was 1:5). Although these newly developed complexes exhibited outstanding activity with respect to the conversion of cyclohexene oxide, none of them proved capable of converting propylene oxide to the copolymer. The most promising system identified for the copolymerisation of propylene oxide and CO<sub>2</sub> was the double-metal cyanide (DMC) catalyst system (Figure 2), which has the general sum formula Zn<sub>3</sub>[Co(CN)<sub>6</sub>]<sub>2</sub>ZnCl<sub>2</sub>·H<sub>2</sub>O·ROH, where R denotes an organic residue. The DMC catalyst system was developed further and resulted in an outstanding productivity of 5200–10700 g (PPP) per gram of catalyst at a selectivity of 94–98% and a catalyst load of the order of 100 ppm depending on requirements, and was in some cases even greater.

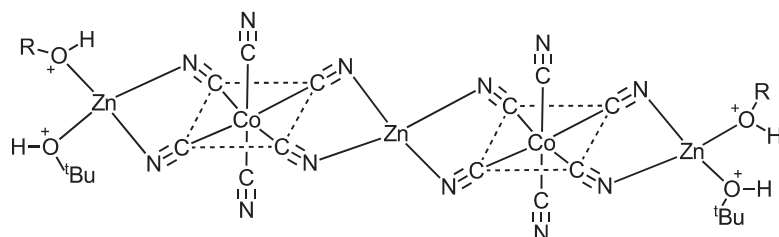

Fig. 8:  
Schematic representation  
of a double-metal cyanide  
catalyst (DMC).

By carefully controlling the composition of the reaction system, the viscosity and CO<sub>2</sub>-content could be varied across a wide range. By selecting different starter molecules it also proved possible to synthesise copolymers with different functionalities, i.e. with different numbers of hydroxyl groups per polymer molecule.

The aim of the subproject ‘**Aromatic Carbonates**’ was to develop an economical, phosgene-free synthetic route to diphenyl carbonate (DPC). These DPC molecules can then undergo further reaction with bisphenol A to produce polycarbonates. The subproject conducted research into catalytic systems that would be capable of catalysing the reaction between phenol and CO<sub>2</sub> or CO to yield diphenyl carbonate. Experiments involving palladium-based catalyst candidates failed as it was not possible to stabilise the catalysts during the reaction. Direct carbonylation of phenol to DPC was achieved with the aid of novel heterobimetallic catalysts, but the activity displayed was low. Metal-free triazine-based catalysts were able to convert

CO<sub>2</sub> and epichlorohydrin to produce a cyclic carbonate, however, subsequent transesterification of the cyclic carbonate to form DPC failed.

### 1.2.4 Exploitation, commercialisation and dissemination of results

The fundamental research work carried out in the ‘Dream Reactions’ project has yielded important information, particularly with respect to catalytic routes to polyether polycarbonate polyols, and this has opened up new avenues to explore in future projects.

Process scale-up and the production of the first sample quantities were achieved in the BMBF-funded follow-up project ‘Dream Production’. In addition to examining the use of industrial CO<sub>2</sub> from a power plant, the ‘Dream Production’ project also conducted a systematic LCA of the overall process.

The results concerning the catalysed production of polyether polycarbonate polyols acquired during the ‘Dream Reactions’ and ‘Dream Production’ projects provide a basis for future commercialisation. Building on the results of the ‘Dream’ projects, a plant with a production capacity of 5000 metric tons of PPP per year has been established in Dormagen Industry Park in order to demonstrate the feasibility of producing CO<sub>2</sub>-based polyols on a commercial scale. The project was showcased as part of an exhibition stand at the 2016 *Woche der Umwelt* (‘Environment Week’), which was organised by the German Federal Environmental Foundation (DBU) and the Office of the Federal President in Bellevue Palace in Berlin.

The project results and findings were disseminated to the scientific community via presentations at conferences and publications in international journals (Green Chemistry, ChemSusChem, etc.). A number of *Diplom* and PhD research theses were completed over the course of the project and two patents were also registered.

#### References:

<https://www.woche-der-umwelt.de/> (retrieved on 24 June 2016)

# 1.3 CO<sub>2</sub> as a polymer building block

BMBF Project FKZ 033RC0902

Project Coordinator: Prof. Bernhard Rieger, Dr. Carsten Troll, Technische Universität München

Project Partner: BASF, Siemens, Universität Hamburg

## 1.3.1 Introduction

Carbon dioxide is both a greenhouse gas and an inexpensive readily available raw material. The collaborative project 'CO<sub>2</sub> as a polymer building block' aims to transform CO<sub>2</sub> into a usable molecular building block for synthesising high-value polymers and thus contribute to solving the climate protection and resource management challenges that are the focus of the German government's High-Tech Strategy. The project concentrates solely on CO<sub>2</sub> utilisation strategies that involve oligomeric and macromolecular chemistry. In addition to assessing the technical feasibility of potential CO<sub>2</sub> utilisation routes, the project will also analyse them in terms of environmental impact and economic viability. From a chemical perspective, the project will focus on two main areas of research: catalytic systems that facilitate the polymerisation reactions, and the properties of the polymer products. New approaches will lead to the development of more active catalysts that will, in turn, enable the more efficient copolymerisation of carbon dioxide with epoxides to form polycarbonates. The polymers themselves are based to about 50% on O<sub>2</sub>/CO<sub>2</sub> and are environmentally compatible. Depending on the epoxides used, the product polymers are characterised by their biodegradability, their excellent haptic properties, optical transparency and very interesting mechanical and thermal properties. Since Inoue and co-workers first discovered in 1969 that a mixture of ZnEt<sub>2</sub> and H<sub>2</sub>O actively catalysed the alternating copolymerisation of propylene oxide (PO) and CO<sub>2</sub> there

Fig. 9:  
Copolymerization of carbon dioxide with epoxides to polycarbonates

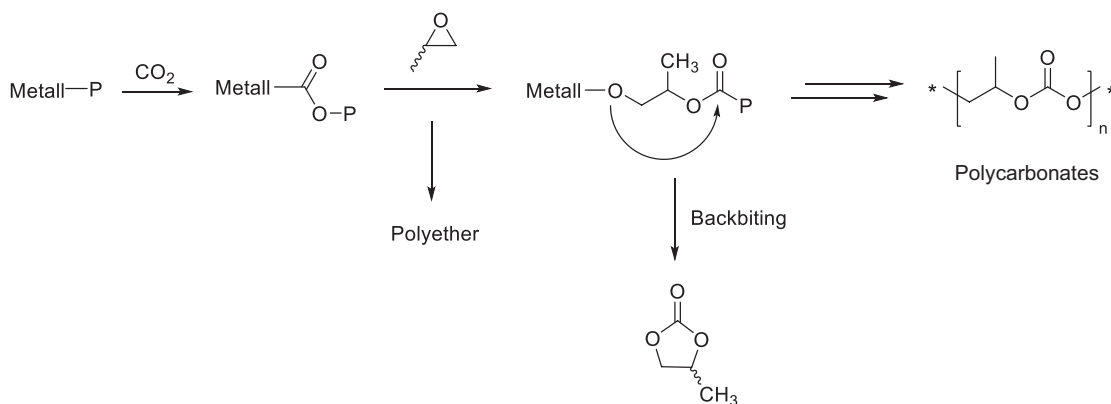

have been numerous articles published on the subject. The copolymerisation is based on consecutive coordination and insertion steps.

The structure of the catalyst plays a major role in the copolymerisation reaction and is the key to determining technical and commercial viability. Thermodynamically favoured side reactions, such as the formation of polyethers by homopolymerisation of the oxiranes or the formation of cyclic carbonates via a backbiting reaction have to be suppressed. Both homogeneous and heterogeneous metalorganic compounds are used as catalysts. Compounds that are active for polymerisation include zinc, aluminium and chromium complexes, but also insoluble zinc compounds, such as those that form when diethyl zinc reacts with water, alcohols, phenols or carboxylic acids. In this project the goal is to use CO<sub>2</sub> as a synthetic building block in the formation of polymeric materials. Custom-designed metalorganic catalysts will be used to provide resource-friendly and energy-efficient syntheses of polymers via the reaction of carbon dioxide with the reactive C<sub>3</sub> building block propylene oxide. The resulting polycarbonates and polyurethanes are important starting materials for engineering materials, polymer films and foams. The polymeric materials produced in the project will be analysed in detail to determine their properties and optimised to enable their use in novel applications. Another project goal is to adjust the service temperature of the polymer material within certain limits by inserting additional termonomers or, alternatively, by including suitable fillers or blending components. New concepts for controlling molecular weight will be exploited to enable the direct production of oligomeric polycarbonate building blocks

Fig. 10:  
Synthesis routes to  
polymeric materials.

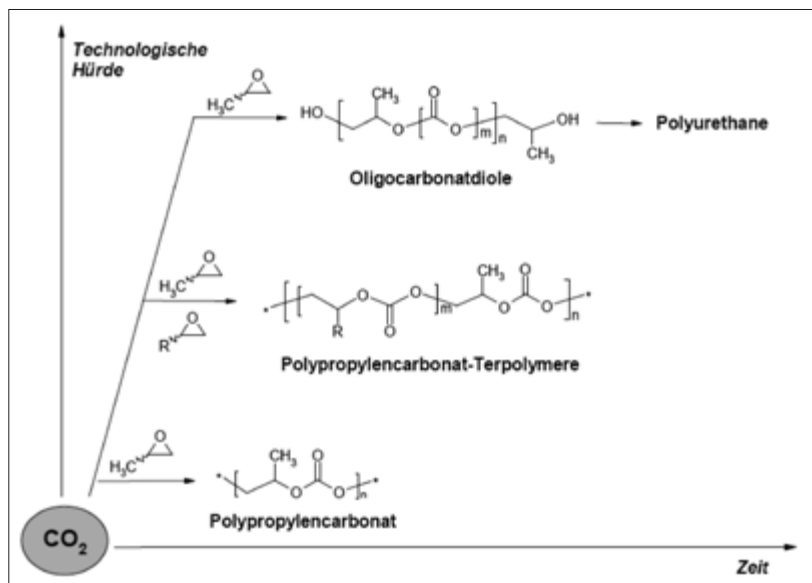

for use in polyurethane synthesis. For products with commercial potential, a process will be developed that meets the requirements for industrial-scale implementation. The figure below shows synthetic routes to polymeric materials that are to be studied during the project. The time requirements for the different reaction pathways shown will vary depending on the specific technical challenges presented.

### 1.3.2 Development of new highly active catalysts for the production of polycarbonates

At the beginning of the project, the focus was on using zinc glutarates as cost-effective catalysts for the copolymerisation of propylene oxide and CO<sub>2</sub>. The disadvantage of these heterogeneous catalysts is their low activity in the copolymerisation reaction. Studies have shown that copolymerisation occurs on the surface of the zinc glutarate particles, which is why the particles were very finely divided and activated in water. While this led to an improvement in catalyst activity, the observed increase was not as great as had been hoped and was less than what was needed. By combining careful analysis of the crystal structures of zinc succinate, zinc glutarate, zinc adipate and zinc pimelate with copolymerisation experiments and theoretical calculations it was possible to show that the optimum Zn-Zn distance lies between 4.3 Å and 5.0 Å.<sup>2</sup> However, studying surface structure-activity relations has identified a number of obstacles. Even if it were possible to reduce the size of the zinc glutarate particles so that they had the size of the crystallographic unit cell, the activity would still not have reached the level expected of a highly active catalyst. Attention therefore turned to studying homogeneous systems of dinuclear zinc systems as they enable higher activity in the copolymerisation of propylene oxide and carbon dioxide. In light of these considerations, the decision was made to put further work on heterogeneous catalytic systems on hold and to focus on homogeneous systems as higher levels of activity can be achieved with the latter. Another advantage of studying single-site catalysts is that the analysis of the reaction mechanism is usually simpler. Theoretical calculations (P. Deglmann, BASF) showed that depolymerisation (backbiting) is sterically hindered in the copolymerisation of cyclohexene oxide (CHO) and CO<sub>2</sub>. Chain growth is therefore strongly favoured over depolymerisation, in contrast to the copolymerisation reaction involving propylene oxide.<sup>3</sup> To incorporate this finding into the catalyst design it is necessary to synthesise catalysts with high Lewis acidity at the metal centres in order to generate stronger metal-oxygen bonds. Beta-diketiminato complexes were therefore synthesised, as the Lewis acidity of the zinc centre could be controlled by using different acetylacetonate derivatives. A large number of dinuclear  $\beta$ -diketiminato complexes were synthesised, two of which showed extremely high activity for the copolymerisation

of carbon dioxide and cyclohexene oxide.<sup>4,5</sup> With a turnover frequency of 155,000 h<sup>-1</sup> and molar masses of up to 350 kg/mol, complex 2 is the most active catalyst discovered thus far for the production of poly(cyclohexene carbonate).<sup>5</sup>

Fig. 11:  
Active catalysts for the  
copolymerization of CO<sub>2</sub>  
and cyclohexene oxide

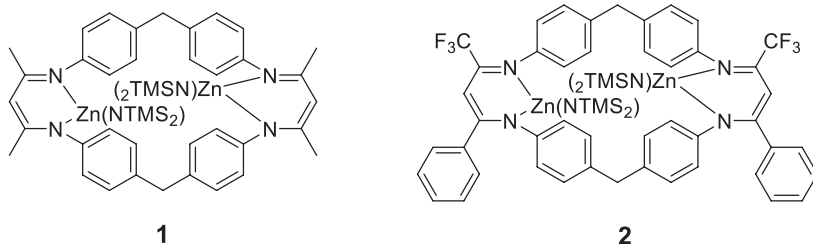

Kinetic studies on complex 1 showed a first-order dependence on catalyst concentration. This indicates that both metal centres are involved in the rapid formation of the copolymer. Further studies of the effect of carbon dioxide pressure and epoxide concentration indicate that the mechanistic behaviour is clearly very different to that known from studies of mononuclear complexes. A strong dependence on the CO<sub>2</sub> concentration in solution was also observed. The concentration of epoxide was not found to be significantly rate limiting. Increasing the pressure of carbon dioxide can, however, reverse this finding. This is believed to be due to the rapid ring opening of the epoxide by the catalyst, making CO<sub>2</sub> diffusion or insertion more rate limiting.<sup>4</sup> However, under the conditions tested, neither of the catalysts 1 or 2 showed any activity for the copolymerisation of CO<sub>2</sub> and propylene oxide. Terpolymerisation experiments involving PO/CHO/CO<sub>2</sub> and theoretical computations by P. Degelmann showed that after the initial single opening of the epoxide ring an alkoxide carbonato species forms, which in the case of the PO/CO<sub>2</sub> copolymerisation represents the resting state of the catalytic cycle. The activation barrier for the subsequent CO<sub>2</sub> insertion (104.8 kJ/mol) is significantly higher than that in the CHO/CO<sub>2</sub> copolymerisation reaction (65.9 kJ/mol).<sup>6</sup>

Fig. 12:  
Stable six-membered resting  
state during CO<sub>2</sub>/PO  
copolymerisation

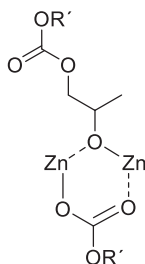



### 1.3.3 Polycarbonates exhibiting superior temperature resistance

Work aimed at adjusting the service temperature of the polymer material within certain limits and of optimising other material properties was based around the idea of inserting additional termonomers or, alternatively, including suitable fillers or blending components. The project team was successful in producing terpolymers from propylene oxide, carbon dioxide and other epoxides. However, the catalysts used definitely need further optimisation. Unfortunately, the resulting terpolymers did not show the desired property of a heat-distortion temperature substantially higher than that of poly(propylene carbonate) (PPC). The price of the polymers also rises with increasing epoxide content and the percentage mass fraction of CO<sub>2</sub> in the polymer decreases accordingly. The benefits of using CO<sub>2</sub> as a monomer – low procurement costs and high CO<sub>2</sub> content in the polymer – are therefore significantly lower with terpolymers than with pure copolymers made from CO<sub>2</sub> and an epoxide.

Promising results were, however, achieved using PPC blends with other polymers. In one set of experiments, blends of PPC were produced using new biodegradable polymers from the neighbouring group of ‘biopolymers’ and the mechanical and thermal properties of the blends were then studied. In other studies, blends were created with non-biodegradable polymers from BASF. Some of the mixing ratios used and some of the polymers suitable for blending with PPC had a significant effect on the properties of PPC even when present in very low quantities. The blends with other biopolymers such as Ecoflex®, PLA and Ecovio® are suitable for use in manufacturing packaging films. The films with PPC blends exhibited improved gas-barrier and tear-propagation properties. Two PPC blends developed in collaboration with Siemens AG showed particularly interesting features and were subsequently developed further and studied in greater detail. The PPC-PLA blends exhibited properties similar to polystyrene and could be used to create injection-moulded objects. However, it was the PPC-PHB blends that showed greatest promise, and, working in cooperation with Siemens, these ABS substitutes were used to manufacture a component for the body of a vacuum cleaner.<sup>7</sup>

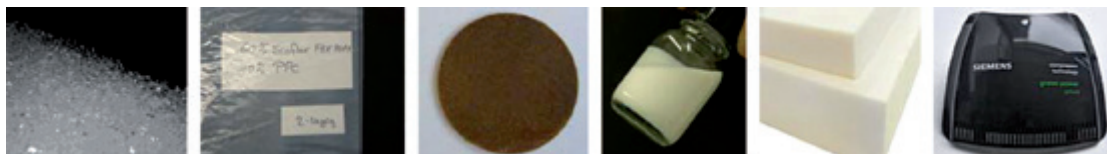

Fig. 13:  
Injection-moulded vacuum  
cleaner part made of PPC blends

### 1.3.4 Exploitation, commercialisation and dissemination of results

The BMBF-funded project 'CO<sub>2</sub> as a polymer building block' was part of the BMBF research and development programme 'Technologies for Sustainability and Climate Protection – Chemical Processes and Use of CO<sub>2</sub>'. The aim of the project was to develop new and improved catalysts for the polymerisation of CO<sub>2</sub> and epoxides. The properties and potential areas of application of the product materials were also studied. A theoretical model was developed that was used to design and successfully predict the activity of catalysts for the polymerisation of CO<sub>2</sub> with epoxides (particularly ethylene oxide (EO), propylene oxide (PO), cyclohexene oxide (CHO)). Theoretical modelling of this type is one of the cornerstones of developing an industrial-scale polymerisation process. The systems identified show great potential for future optimisation. However, it is essential that the activity of the catalysts is improved if industrial applications are to be viable. The CO<sub>2</sub>-based polymer poly(propylene carbonate) (PPC) is very well suited for blending with other biopolymers such as polyester, PLA and PHAs (e.g. PHB). Areas in which these materials can be used include the packaging sector and injection moulding applications (e.g. injection moulded casings, housings). PPC film also performed well in initial tests that examined its suitability for use in carrier bags and as agricultural film. Although PPC is unsuitable for use as a pure film due to its low heat-distortion temperature and stickiness, it was shown to improve the performance of the packaging systems studied when it was used as a component in blended polymers or as a layer in multilayer films.

Fig. 14:  
Applications for PPC  
(from left): PPC granulate,  
film composed of PPC blend,  
WPCs, PPC dispersions, foams,  
casing material made from  
PPC polymer blends



Overall the project produced a number of important results in the field of catalysis and addressed numerous application-driven problems. The results achieved represent a substantial contribution in assessing the industrial potential of these new CO<sub>2</sub>-based polymeric materials.

**References::**

- (1) Inoue, S.; Koinuma, H.; Tsuruta, T. *Makromol. Chem.* **1969**, *130*, 210-220.
- (2) Klaus, S.; Lehenmeier, M. W.; Herdtweck, E.; Deglmann, P.; Ott, A. K.; Rieger, B. *J. Am. Chem. Soc.* **2011**, *133*, 13151-13161.
- (3) Lehenmeier, M. W.; Bruckmeier, C.; Klaus, S.; Dengler, J. E.; Deglmann, P.; Ott, A.-K.; Rieger, B. *Chem. Eur. J.* **2011**, *17*, 8858-8869.
- (4) Lehenmeier, M. W.; Kissling, S.; Altenbuchner, P. T.; Bruckmeier, C.; Deglmann, P.; Brym, A.-K.; Rieger, B. *Angew. Chem. Int. Ed.* **2013**, *52*, 9821-9826.
- (5) Kissling, S.; Lehenmeier, M. W.; Altenbuchner, P. T.; Kronast, A.; Reiter, M.; Deglmann, P.; Seemann, U. B.; Rieger, B. *Chem. Comm.* **2015**, *51*, 4579-4582.
- (6) Kissling, S.; Altenbuchner, P. T.; Lehenmeier, M. W.; Herdtweck, E.; Deglmann, P.; Seemann, U. B.; Rieger, B. *Chem. Eur. J.* **2015**, *21*, 8148-8157.
- (7) URL: <http://w1.siemens.ch/home/ch/de/cc/siemens/energieeffizienz/industrie/Pages/KunststoffausCO2.aspx> (08.06.2016)

# 1.4 Dream Production

## BMBF Project FKZ 033RC1005

Project Coordinator: Dr. Christoph Gürtler, Covestro

Project Partner: Bayer Technology Services, CAT Catalytic Center, RWTH Aachen, RWE

### 1.4.1 Introduction

The idea itself actually seems quite obvious: If humankind produces too much carbon dioxide (CO<sub>2</sub>), causing an imbalance in the natural carbon dioxide cycle, why not attempt to use at least a small part of this inherently harmless gas for some beneficial purpose? This would reduce consumption of other sources of carbon and the 'waste product' CO<sub>2</sub> could be utilised, for example, as feedstock material in the chemical supply chain.

This was the dream of a consortium comprising Covestro (formerly Bayer MaterialScience, BMS), Bayer Technology Services (BTS), RWTH Aachen University (represented by the Leitner, Liauw and Bardow research groups at the CAT Catalytic Centre) and RWE Power AG, who in 2010 began working on the 'Dream Production' project funded by the German Federal Ministry of Education and Research (BMBF). The common project goals were:

1. to supply CO<sub>2</sub> from the flue gas stream of a coal-fired power plant at a purity level suitable for use in chemical synthesis (synthesis grade).
2. to use CO<sub>2</sub> as a C<sub>1</sub> building block in the production of polyether carbonates. The underlying catalytic systems were those already identified and developed in the preceding 'Dream Reactions' project. The novel polyether carbonate products would also be tested, particularly with respect to their use in manufacturing samples of polyurethane.
3. to catalytically activate CO<sub>2</sub> as a C<sub>1</sub> building block so that it can react with amines to produce isocyanates. The aim was to identify an improved, preferentially catalytic process so that over the long-term polyurethanes can be produced from CO<sub>2</sub>-based polyether carbonates and isocyanates.

The idea of using CO<sub>2</sub> as a chemical building block is not new. Chemists were conducting research in this field as early as the 1960s. The challenge was and is to find an economically and environmentally viable process that would allow the relatively inert CO<sub>2</sub> molecule to be used in industrial chemical synthesis.

Prior to the start of the 'Dream Production' project, separating carbon dioxide from power plant flue gas streams ('carbon capture') was still only at the pilot-plant stage of development. At that time, the work was focused predominantly on establishing energy-efficient scrubbing processes and on identifying stable CO<sub>2</sub> solvents to provide the most cost-effective means of reducing the CO<sub>2</sub> burden produced by power plants. However, the quality of the captured CO<sub>2</sub> had to be sufficiently high for it to be utilisable in potential downstream chemical conversion processes.

The CO<sub>2</sub>-based polyether carbonate target products are proposed as an alternative to the conventional polyether polyols that are formed entirely from fossil-based chemical building blocks. The first lab-scale quantities of these polyether carbonates were produced in the preceding 'Dream Reactions' project. Because of the high pressures involved, scaling up the reaction required finding new chemical engineering solutions. It was also unclear what effect impurities in the CO<sub>2</sub> captured from power plant flue gas streams would have on catalyst behaviour.

The reaction of CO<sub>2</sub> with amines to carbamino acids in the production of isocyanates has been the subject of a number of previous studies. Areas in which improvements were required included catalyst development, evaluating the range of potential synthetic applications and process engineering concepts for removing water during the dehydration step.

## 1.4.2 Project description

### Goal

The goal of the 'Dream Production' project was to develop processes that would enable the utilisation of CO<sub>2</sub> as a synthetic building block for the industrial synthesis of polymers. This involved capturing CO<sub>2</sub> from the flue gas stream of a coal-fired power plant and supplying it at a level of purity compatible with use in industrial synthetic chemistry. The focus of the work examining the utilisation of CO<sub>2</sub> as a C<sub>1</sub> building block was on the production of polyether polycarbonate polyols. Over the course of the project these polyols were processed further to yield samples of polyurethane whose material properties were then studied.

To broaden understanding of the field, the principle of catalytically activating CO<sub>2</sub> was applied to the production of isocyanates from the reaction of amines and CO<sub>2</sub>. The objective was to identify an improved, preferentially catalytic process that would, over the long-term, enable polyurethanes to be produced from CO<sub>2</sub>-based polyether carbonates and CO<sub>2</sub>-based isocyanates.

The research project aimed to generate ideas and incentives for subsequent work aimed at preparing and developing innovative industrially relevant reactions and technologies. The project aimed to significantly strengthen Germany's position as a technology hub, particularly the market competitiveness of companies involved in the carbon capture and utilisation field.

The presence of an internationally highly respected university within the project consortium provided an opportunity to study the utilisation of CO<sub>2</sub> as a synthetic building block for polymers from a scientific perspective and to establish this field as a fruitful area of chemical enquiry.

### Project planning and project execution

The project was split into seven work packages that were carried out by the respective project partners. Work package 1 (WP1) described the capture of CO<sub>2</sub> from power plant flue gas streams, the subsequent CO<sub>2</sub> liquefaction and filling operations, supply to project partners and quality monitoring. In WP2, the captured CO<sub>2</sub> was examined for compatibility with chemical catalysts and reaction-related and microkinetic data was gathered. Spectroscopic measurements and mathematical modelling work was conducted in WP5. In WP3, a mini-plant was designed, built and operated to study the reaction of propylene oxide with CO<sub>2</sub>.

The suitability of the material samples for use in technical processes and their product properties were examined in WP4. WP6 dealt with fundamen-

Fig. 15:  
Work packages carried out  
by the partners in the  
'Dream Production' project

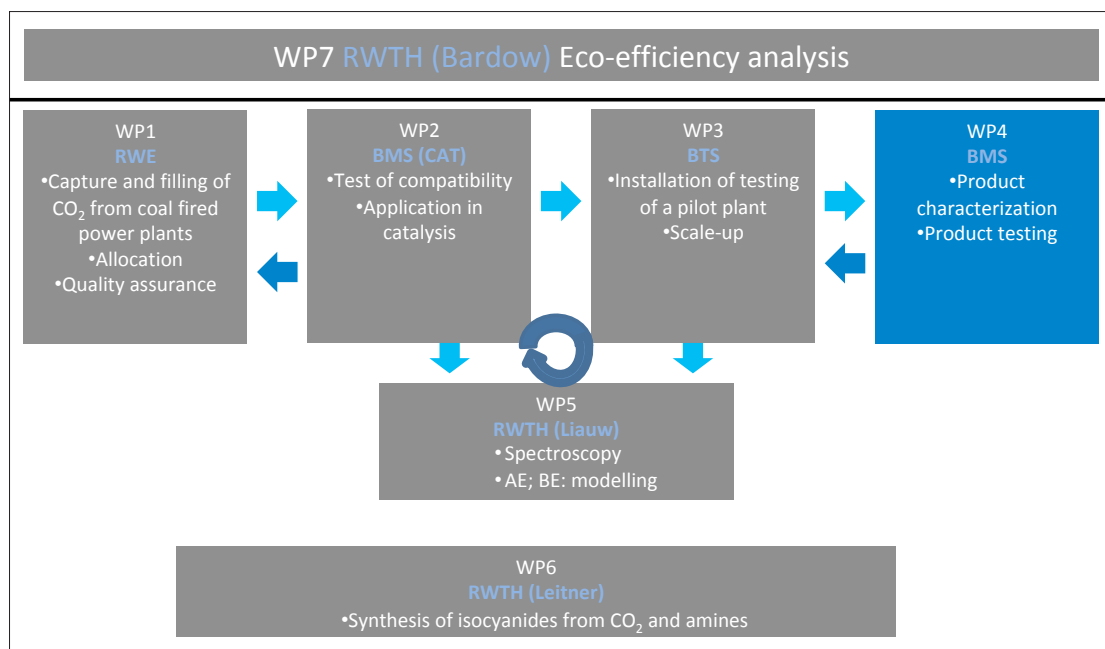

tal aspects of the activation of CO<sub>2</sub>. A life cycle assessment study was conducted in WP7 in order to address environmental impact issues relevant to the project. Figure 15 shows an overview of the component work packages within the collaborative project.

### 1.4.3 Results

As part of the 'Dream Production' project, the pilot-scale carbon capture system at the RWE power plant in Niederaußem was expanded by adding a liquefaction and filling unit. The CO<sub>2</sub> recovered from the carbon capture system was made available to all of the project partners. Irrespective of the type of purification method used, the quality of the industrially recovered CO<sub>2</sub> was always of a quality high enough for it be employed in the proposed synthesis reactions.

In order to produce samples of the polyether carbonate polyols in sufficient quantities, the laboratory-scale production system used in the preceding project was scaled up appropriately (see Figure 16). This mini-plant was used to develop the production process and to optimise the composition of the reaction mixture used in fabricating the polyether carbonate polyols. Plant operating modes of increasing complexity were employed, starting with a semi-batch system, which was followed by a continued-addition-of-starter (CAOS) semi-batch set-up, and finally a CAOS continuous process.

The mini-plant enabled sample quantities of different types of polyether carbonate polyols to be produced and tested in a variety of polyurethane



Fig. 16:  
The completed mini-plant  
for the production of  
CO<sub>2</sub>-containing polyols



applications. As sufficient quantities of polyol could be produced, it was possible to fabricate not only lab-scale quantities of polyurethane, but also larger amounts, thus allowing the polyurethane to be tested as a soft foam material, which was its main industrial application. The results showed that in the standard reaction mixtures, CO<sub>2</sub>-derived polyols could be used as substitutes for the conventional polyols derived from crude oil, either as partial replacements (by adding the CO<sub>2</sub>-polyols to the conventional polyol) or as a full one-to-one substitute. The polyurethanes produced using the CO<sub>2</sub>-derived polyols exhibited properties similar to those of polyurethanes manufactured using polyols synthesised solely from crude oil. It was also found that the polyurethane foams produced using the CO<sub>2</sub>-derived polyols showed a lower fire load.

The accompanying life cycle assessment analysis clearly showed that the polyols produced in the 'Dream Production' project, which contained about 20 % CO<sub>2</sub>, were associated with lower carbon emissions (as measured in kilograms of CO<sub>2</sub>-equivalent per kilogram of polyol) when compared with conventional polyols derived from crude oil. The consumption of fossil-based raw materials per kilogram of product can also be reduced substantially by utilising CO<sub>2</sub> that has been captured from industrial flue gas systems. In addition, model reactions involving CO<sub>2</sub> and primary amines to yield dialkyl urea were successfully performed as part of the work examining the viability of manufacturing CO<sub>2</sub>-based isocyanates.

#### 1.4.4 Exploitation, commercialisation and dissemination of results

The project results were disseminated to the scientific community and to the wider public via numerous publications, talks and presentations, Master's and Diplom theses, patents and appearances at trade fairs and exhibitions. The focus here was not just on engaging in scientific discussion with experts in the field, but on promoting public acceptance of CO<sub>2</sub> as a useful chemical building block by participating in roundtable discussions at the Institute for Advanced Sustainability Studies (IASS) and in accompanying promotional exercises organised by DECHEMA. The detailed life cycle assessment of industrial processes that utilise CO<sub>2</sub> to manufacture products, such as polyether carbonate polyols, was an essential component in the discussions referred to above and provides the basic understanding and insight necessary for many other related projects, such as 'Dream Polymers', 'Dream Polyols' or 'Production Dreams'.

The insight gained during the 'Dream Production' project into the carbon capture process, particularly with regard to CO<sub>2</sub> quality, is already being used in other CO<sub>2</sub> utilisation projects. For example, a catalyst test facility has been

operating in Niederaußem since 2013, where it is being used to study the reaction of hydrogen and CO<sub>2</sub> captured from the power plant’s flue gas stream to form methane or methanol – a process commonly referred to as Power-to-Gas. In order to create realistic operating conditions, the carbon dioxide used is that from the CO<sub>2</sub> liquefaction and filling unit at the Niederaußem plant. Assessing the success of this P2G process has involved use of the results generated by the ‘Dream Production’ project.

The project results concerning the chemical and process engineering aspects of the new polyether carbonate polyol technology have provided a foundation for successfully scaling up the technology to the demonstration level. Covestro has invested around 15 million euros in a demonstration facility with a production volume of around 5000 metric tons per year at its Dormagen site, which went on stream in 2016. The CO<sub>2</sub>-containing polyols are now being sold under the cardyon™ name (see Figure 3). One of the first customers for this new product is the mattress manufacturer Recticel. The project has significantly strengthened Germany’s position as a technology hub, particularly the market competitiveness of companies involved in the carbon capture and utilisation field.



Fig. 17: Marketing of CO<sub>2</sub>-derived polyols under the cardyon™ name.

The project has also earned a number of national and international awards in recognition of its innovative impact, including: Top 3 Deutscher Nachhaltigkeitspreis / Initiativen [Top 3 in the National German Sustainability Award/ Initiatives] (2011); Land der Ideen (‘Land of Ideas’ – German Government and Industry Award) (2012); KlimaExpo.NRW (2015, Figure 4), EUROPUR Sustainability Award (2016); ICIS Innovation Award (2016); Sustainia100 (2016); CEFIC European Responsible Care Award, Category: Environment Award (2016).



Fig. 18: The ‘Dream Production’ team receiving an award at the KlimaExpo.NRW.

# 1.5 Valery - Energy efficient synthesis of aliphatic aldehydes from alkanes and carbon dioxide: Valeradlehyde from butane and CO<sub>2</sub>

BMBF Project FKZ 033RC1011

Project Coordinator: Jennifer Julis, Evonik Creavis GmbH

Project Partner: Leibniz-Institut für Katalyse e.V., CVT Chemical Engineering

## 1.5.1 Introduction

The use of CO<sub>2</sub> not only enables the return of the climate-relevant gas to the value chain, but offers an access to an alternative carbon source. CO<sub>2</sub> is therefore an interesting C<sub>1</sub> building block for chemical synthesis, which is available in an almost unlimited and cost-effective form. At the same time, however, CO<sub>2</sub> is extremely stable and its conversion to higher-quality products is a major challenge. In industry, there are therefore only a few examples of the successful industrial-scale use of CO<sub>2</sub>, for example the synthesis of urea (approx. 80 million t/a), methanol (approx. 2 million t/a), salicylic acid (approx. 0.025 million t/a) and cyclic carbonates (approx. 0.04 million t/a). Further industrial-scale applications would therefore be desirable. This gap needs to be closed by new industrially relevant processes in which CO<sub>2</sub> is used as a source of carbon.

The Valery project focused on the development of a new process for the production of basic chemicals on an industrial scale based on CO<sub>2</sub>. The basic idea was to combine the photocatalytic dehydrogenation of alkanes to olefins with the hydroformylation with CO<sub>2</sub> in order to reach aldehyde. Aldehydes are important intermediates in the petrochemical value chain. They are currently produced on a million ton scale by hydroformylation of olefins with synthesis gas (CO/H<sub>2</sub>).

Substitution of olefins with considerably cheaper alkanes, as well as the use of CO<sub>2</sub> instead of CO in synthesis gas, would not only be extremely interesting from an economic point of view, but at the same time would also enable greater raw material flexibility and greater independence from fossil raw materials. A few publications describe the hydroformylation of olefins with CO<sub>2</sub>. Tominaga et al. reported on the hydroformylation of linear alkenes with CO<sub>2</sub> on ruthenium catalysts. However, the catalyst systems used so far showed only moderate chemical selectivity and activity, as well as increased

hydrogenation activity, so that a technical application is currently irrelevant. Similarly, photocatalytic dehydrogenation of alkanes to olefins is involved. The dehydrogenation of alkanes is carried out on a large scale by means of heterogeneous catalysis in the gas phase at high temperatures. Due to the high energy requirement and the associated costs, catalytic dehydration is used only occasionally. An alternative energy-efficient process such as photocatalytic dehydration is therefore desirable. As a few publications show, the photocatalytic conversion of alkanes without acceptor is possible in principle. However, the sales are very low, so that the reaction is still far from a large-scale application.

## 1.5.2 Project description

The aim of the „Valery“ project was to develop a new process for the production of valeraldehyde. Specifically, the hydroformylation of butene and carbon monoxide to valeraldehyde should be replaced by an alternative process by substituting the toxic carbon monoxide with carbon dioxide and by providing butene to butane by energy-efficient dehydration. First of all, n-butane should be photocatalytically dehydrated. The resulting 1-butene should then be converted to valeraldehyde in a hydroformylation with CO<sub>2</sub>, whereby one of the two equivalents of hydrogen required for hydroformylation with CO<sub>2</sub> is provided by photocatalytic dehydrogenation. Within the scope of the project, technically relevant homogeneous catalysts for the photocatalytic dehydrogenation or direct carbonylation of alkanes as well as for the hydroformylation with CO<sub>2</sub> were to be developed. The catalyst development should be supported by computer-chemical calculations in order to enable a targeted catalyst design. In addition, the catalyst systems should be immobilised to ensure a simplified separation of product and catalyst. In addition to the development of the catalysts, kinetic investigations should be carried out at the same time, on the basis of which a corresponding reaction model and the design of the overall process should be carried out. A final life cycle assessment, taking into account the entire process chain, should provide information on the ecological sustainability of the new process, so that a holistic picture of the feasibility of photocatalytic dehydration and subsequent hydroformylation with CO<sub>2</sub> to form aldehydes can be obtained.

## 1.5.3 Results

Existing catalyst systems have been optimized for photocatalytic dehydrogenation as well as for hydroformylation with CO<sub>2</sub> and new catalyst systems have been developed. In the case of photocatalytic dehydrogenation, the optimized reaction conditions with the catalyst system Rh (PMe<sub>3</sub>)<sub>2</sub> (CO)Cl-Com-

plex have led to the highest catalyst turnover figures for the photocatalytic dehydrogenation of alkanes to date. A large number of alkanes, cycloalkanes and butane were dehydrated at low temperatures in the presence of UV light. In situ spectroscopic investigations and control tests formed the basis for a better understanding of the system. However, photocatalytic dehydration with sunlight as the light source could not be achieved, nor could direct carbonylation. For the hydroformylation with CO<sub>2</sub>, a ruthenium-based ligane-supported catalyst system was successfully developed, which is currently the best system for the hydroformylation of olefins with CO<sub>2</sub> in its activity. With the newly developed catalyst system, the hydrogenation activity could be almost completely suppressed and high selectivities to aldehyde/alcohol could be observed. In addition, it has been shown that the retro-water-gas-shift reaction, the conversion of CO<sub>2</sub> to CO, is already taking place at 110 °C with this system. Immobilization tests showed that it was not possible to immobilize the photocatalytically active catalyst, but that heterogenization of the catalyst system for hydroformylation using the SILP (supported-ionic-liquid-phase) concept was possible. The catalyst systems were investigated in kinetic experiments. Based on these investigations, a reactor concept was developed for photocatalytic dehydration with UV light. It turned out that due to the low efficiency of the UV lamps and the high energy consumption associated with it, a reactor system powered by UV light is neither economically nor ecologically sensible. Accordingly, a reactor concept for photocatalytic dehydration with sunlight was developed. Two critical points were identified: one was the area required for the reactor and the other was the safety concept for a pressure-operated glass reactor. However, both points can be addressed by appropriate choice of materials and reactor design. Finally, the new process was evaluated economically and ecologically. It has been shown that the new process is an extremely attractive process in economic terms, since the use of alkanes and CO<sub>2</sub> as C1 building blocks results in cost-effective raw materials and at the same time in an expansion of the raw material base. On the other hand, the new process's energy consumption is considerably lower than that of the established technology due to the energy-efficient photocatalytic dehydration with sunlight. The life cycle assessment has shown that the new process also has an immense ecological improvement potential. In all environmental impact categories, the new method is better than the benchmark and a decrease of up to 70 % could be observed in the individual sustainability criteria. From an economic and ecological point of view, the new process is therefore an interesting alternative to the conventional production of valeraldehyde, provided that dehydration takes place in sunlight. During the project period, however, it was not possible to identify a suitable catalyst active in photocatalytic dehydration with sunlight.

## 1.5.4 Exploitation

Three patent applications were filed as part of Valery, and four publications have been published in renowned journals such as “*Angewandte Chemie*”.

A large-scale process for the production of valeraldehydes from butane and CO<sub>2</sub> is not yet feasible against the background of the state of the art of knowledge developed in the project. However, corresponding process syntheses, which can serve as a basis for preliminary planning, are completely available. Particularly with regard to photocatalytic dehydrogenation, it is necessary to identify a catalyst system that catalyses photocatalytic dehydrogenation in sunlight. If such a system exists, a suitable photoreactor must be designed that meets the requirements of photocatalytic dehydration and at the same time plant safety. The hydroformylation process step, on the other hand, has reached such a maturity within the framework of the project that it could be implemented on a large scale. The newly acquired technology platform for ruthenium-based carbonylation will therefore be further investigated and expanded. Since the sustainability of the new process is linked to the photochemical step, the process is not yet ready for implementation.

## 1.6 ECCO<sub>2</sub> – Combinatorial electrocatalytic CO<sub>2</sub> reduction

BMBF Project FKZ 033RC1101

Project Coordinator: Dr. Karl Mayrhofer, Forschungszentrum Jülich GmbH  
(Project enforcement at Max-Planck-Institut für Eisenforschung GmbH)

### 1.6.1 Introduction

The electrochemical reduction of CO<sub>2</sub> offers a means of converting CO<sub>2</sub> directly into fuels or feedstock molecules. If the electrolysis process is powered by renewable energy, such an approach offers a means of upgrading CO<sub>2</sub> from an industrial waste product to a useable resource without generating additional greenhouse gas emissions. Industry would then have access to an artificial CO<sub>2</sub> cycle that has been unavailable up until now. This would also provide a means of storing renewable energy in order to compensate for the fluctuating power levels from renewable sources. This is one of the most important tasks required if the transition to a renewables-based energy system is to be achieved. The advantages of electrochemical CO<sub>2</sub> reduction arise in part because only a few energy conversion stages are required, as electricity, which is the most common form of energy produced from renewable sources, is used directly to convert (i.e. electrochemically reduce) CO<sub>2</sub>. Electrochemical CO<sub>2</sub> reduction therefore offers excellent potential for achieving high process efficiency. Another important feature of electrochemical CO<sub>2</sub> reduction is that it has a broad spectrum of potential end products. Depending on the catalyst and process conditions used, the primary products could be hydrocarbons, alcohols, formic acid or carbon monoxide and hydrogen. It is also noteworthy that the necessary thermodynamic potentials lie in the region needed in order to generate hydrogen electrochemically. Therefore instead of using renewable energy to produce hydrogen and then reacting this hydrogen with carbon monoxide in a heterogeneously catalysed reaction to produce fuels, the fuels could be generated directly from renewably sourced electricity. The problem of product storage, which is particularly relevant in the case of hydrogen, is therefore either reduced or eliminated depending on the product concerned. Nevertheless, the development of plants designed for the electrochemical reduction of CO<sub>2</sub> lags seriously behind that of hydrogen electrolysis units or conventional heterogeneous gas catalysis. The main cause of this discrepancy is the challenge of achieving improved process efficiency. Although CO<sub>2</sub> reduction offers a broad range of potential products, the ability to selectively synthesise specific products is limited, but is nevertheless essential if the process is to be implemented cost-effectively. For products such as CO or formic acid, current catalysts exhibit high Fara-



daic efficiencies; for the production of hydrocarbons or alcohols, in contrast, the catalysts presently available generate a multitude of products simultaneously. Without additional workup and purification stages these products are therefore of limited use. The efficiency of the electrochemical conversion is also affected by high overpotentials, which can make the potential actually required to drive the reaction up to 1 V more negative than the thermodynamically determined potential, thus increasing the amount of energy required to perform the CO<sub>2</sub> reduction. The goal of current research in this field is therefore to find catalysts that exhibit both high selectivity and only a small overpotential. The complexity of the reactions involved and their dependence on process parameters results in an almost unlimited optimisation space, which can only be analysed with a significant research effort. Progress in this field will therefore be slow unless new analytical techniques are developed that allow parameters to be varied at a high rate while also guaranteeing high levels of comparability and reproducibility. In particular, fundamental research needs to be carried out if the candidate catalysts are to be examined extensively with respect to their activity, stability and selectivity – an approach that requires the deployment of combinatorial analytical tools. The resulting improved understanding of the electrocatalytic reduction of CO<sub>2</sub> will then enable conclusions to be drawn regarding the development of efficient catalytic materials.

## 1.6.2 Project description

Development will be based around a scanning flow cell (SFC) that is coupled with other analytical methods. The SFC is a sophisticated electrochemical apparatus that enables high-throughput analyses of reactions and surfaces to be performed. In this project, an SFC will for the first time be used for the simultaneous study of the electrochemical activity, stability and selectivity of catalyst materials.

Fig. 19: SFC setup: (A) overview showing pump and positioning table; (B) detailed view with CAD model of a 1 mm cell.

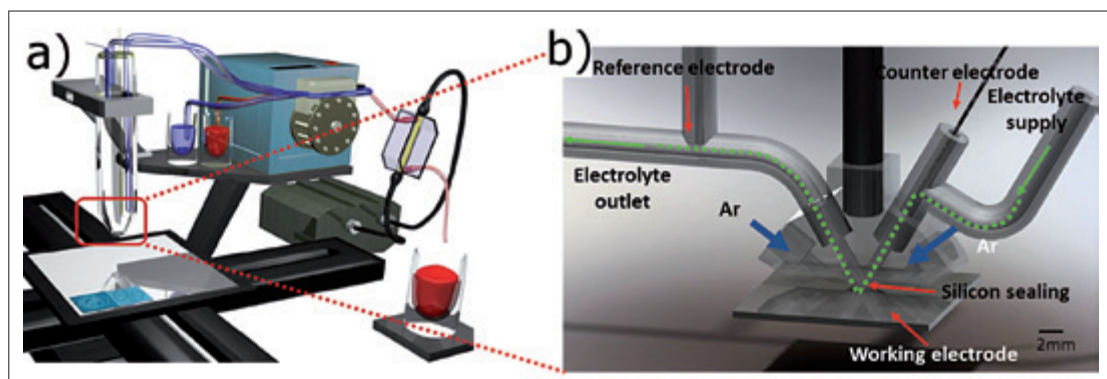

The probe (i.e. the working electrode) is located on an XYZ positioning table, while the reference and counter electrodes are housed within the flow cell itself. Figure 1 depicts a flow cell with a channel diameter of, in this case, 1 mm; diameters ranging from 200  $\mu\text{m}$  to 3 mm are possible. The probe can be moved underneath the cell in any direction and can also be brought into contact with the cell. In the latter case, the electrolyte has contact with the probe via a small orifice at the tip of the v-shaped flow path. Electrolyte solution is continuously pumped through the cell even when the probe is being moved into a new position. In the case of a homogeneously structured working electrode, the benefits of the SFC over more conventional methods are the high level of reproducibility that can be achieved and the speed with which measurements can be conducted. If the working electrode has a graded composition, the speed with which measurements can be performed and the resolution attainable is far superior to that achievable with standard methods of examination. When a graded working electrode is used, changing the location on the electrode automatically changes the composition, and the resolution achievable is then only dependent on the size of the cell orifice. Using a flow cell also means that online analyses of dissolution and

Fig. 20:  
SFC-DEMS CELL:  
the products are fed into  
the MS via a suction tube

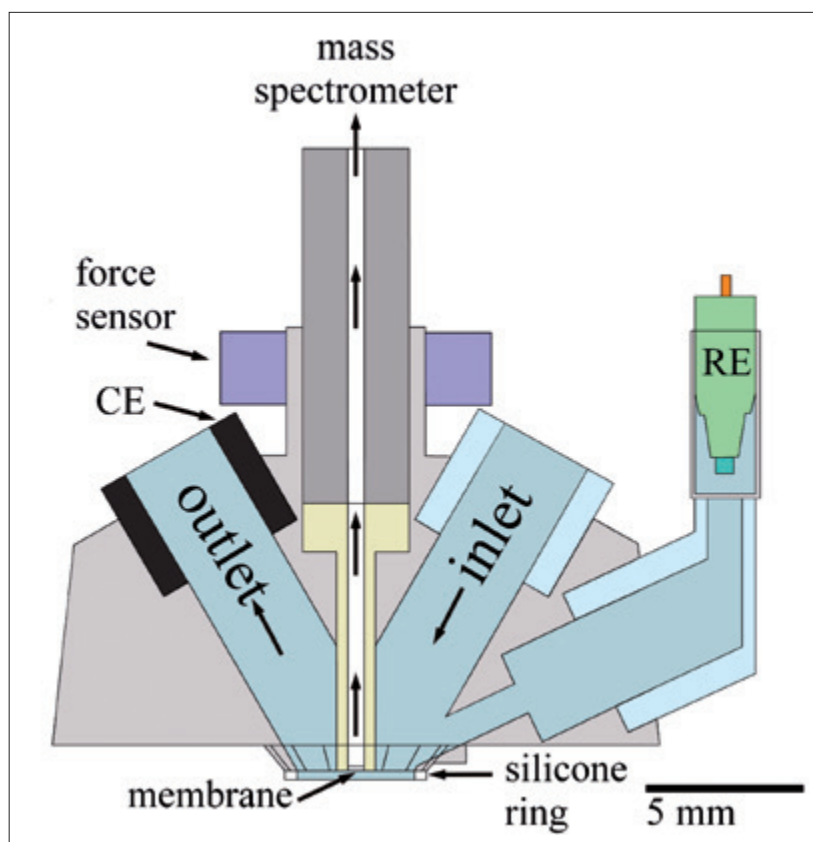

reaction products can be carried out in either a parallel or downstream configuration. A differential electrochemical mass spectrometer (DEMS) is a device used for analysing volatile reaction products that arise during electrochemical reactions. The high time resolution achievable means that correlations with the applied current or the applied voltage can be recorded even at high rates of change. Potentially volatile reaction products are vaporised through a porous Teflon membrane and enter the vacuum system of the mass spectrometer where they are analysed. The small pore size (20 nm) and the hydrophobicity of the membrane ensure that unwanted water and higher boiling components are for the most part retained and do not enter the MS. This project is also the first time that an SFC will be coupled to a DEMS. The design of the SFC will need to be modified to enable coupling and the proposed modifications are shown schematically in Figure 20. The products are evaporated close to the surface and are fed into the MS via a suction tube.

The reproducibility and efficiency with which measurements can be performed using the SFC enables the numerous products formed from the electrochemical reduction of CO<sub>2</sub> to be detected simultaneously and as a function of process parameters such as potential, current or catalyst composition. This unique measurement system shows enormous promise for improving our understanding and assisting the development of systems designed to achieve the electrochemical transformation of CO<sub>2</sub>. The SFC will also be coupled to an inductively coupled plasma mass spectrometer (ICP-MS). In this case, the electrolyte is fed into the ICP-MS from the output port of the SFC.

The metal species present in the electrolyte due to the dissolution of the catalyst material are analysable down to a detection limit of about 10 ppt and thus provide very important information on catalyst stability. Here, too, the coupling of the SFC to a mass spectrometer ensures that the measurements are performed efficiently and offers a unique opportunity to monitor dissolution behaviour by recording transient voltage and current profiles at high time resolution. Besides the electrode material itself, the experimental parameters (pH, buffering capacity, temperature, electrolyte ions, current and voltage measurements, etc.) also play an important role in the electrochemical reduction of CO<sub>2</sub>. The experimental setup described above enables these parameters to be varied automatically and very rapidly so that the impact of an individual parameter can be determined to a high level of reproducibility. Initially, one system (e.g. copper) will be examined in detail to improve our understanding of the CO<sub>2</sub> reduction process and to identify the optimum conditions for a subsequent material screening campaign. Later on in the project, experiments will be carried out on material libraries. Material libraries are thin-film samples of materials formed using physical vapour deposition

(PVD) in which the composition of the alloy gradually varies across the film. The influence of alloying elements on activity, stability and selectivity can therefore be systematically examined at a high level of resolution with respect to material composition. The results from these preliminary studies will then be transferred to industrial catalysts. Carbon-supported nanoparticles are the catalysts of choice in industrial applications as they offer a large surface area while requiring only a relatively small amount of the active material. However, further analysis of these catalysts will definitely be required, as it is highly unlikely that the results from model systems, such as thin film samples on nanoparticles, can be transferred to systems designed for industrial use. The measurement process is also greatly simplified in this case, as multiple catalysts can be deposited as material spots onto a conducting inactive surface. The dimensions of the catalyst spots can be chosen so that they are enclosed by the orifice of the SFC, which ensures that no active material is transferred from one catalyst to another when moving to a new measurement spot. As not all of the reaction products can be detected by the DEMS, an additional setup with coupled gas chromatographs (GC) is also required. This setup has a conventional glass cell with one of the GCs drawing samples from the gas phase above the electrolyte, which enables it to analyse all of the gaseous products, while another GC is used to analyse samples taken by hand from the liquid phase. In a GC, the analytes are transported through a chromatographic column whose inside is coated with a (stationary) liquid phase. The retention time of an analyte molecule in the liquid phase determines the time that the molecule spends in the column. As different molecules have different retention times, the molecules within the analyte mixture can therefore be separated in time. The comprehensive study of CO<sub>2</sub> reduction described above should yield new insights that will help to implement an artificial, industrially relevant CO<sub>2</sub> cycle.

### 1.6.3 Results

Both of the proposed SFC setups (an SFC with coupled DEMS and an SFC with a coupled ICP-MS) were realised experimentally and used extensively in studying electrochemical CO<sub>2</sub> reduction. Only selected results will be presented here, as a more comprehensive description would be beyond the scope of the present review. Once the optimum operating conditions and measurement setup had been derived from the results of the initial parameter studies on a copper system, attention moved to examining a copper-cobalt material library. This showed that the ratio of copper to cobalt strongly influences not only the general production of hydrocarbons and alcohols, but also the relative amounts of C<sub>1</sub> and C<sub>2</sub> products. It could be shown that as the cobalt concentration increases, the amount of methane produced decreases continuously, while the production of ethylene and ethanol reach-

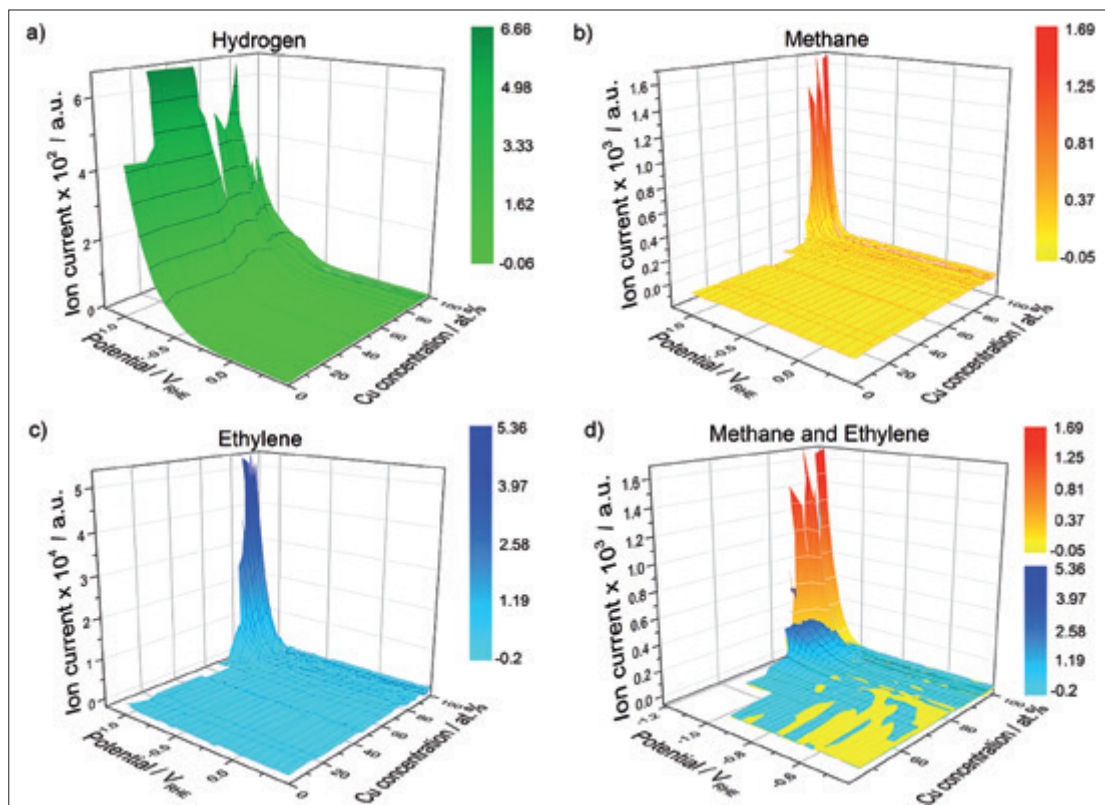

es its maximum at an atomic concentration of copper of about 95 % after which it decreases. Figure 21 shows the results of a DEMS analysis for linear potential curves as a function of copper concentration. The plots show the measured intensities for hydrogen, methane and ethylene. For ease of comparison, the results for ethylene and methane were also displayed together in a single plot. It can be seen that the ethylene production increases up to a copper concentration of about 90 at% after which it decreases. XRD and SEM analyses demonstrate that this shift is not due to the formation of new phases nor to changes in surface structure. It is presumed that the absorption energies are altered by the presence of a certain amount of cobalt such that the intermediates responsible for the formation of C<sub>2</sub> species are bound more effectively. Similar trends were also observed in studies of industrial catalysts.

Fig. 21:  
3 DEMS Signal for A) H<sub>2</sub>, B) CH<sub>4</sub>,  
C) C<sub>2</sub>H<sub>4</sub>, D) CH<sub>4</sub>+C<sub>2</sub>H<sub>4</sub> as a function  
of copper concentration and  
potential

## 1.6.4 Exploitation, commercialisation and dissemination of results

The electrochemical reduction of CO<sub>2</sub> is a promising technology that still requires further development but that fits perfectly into a future renewables-

based energy landscape. The project has laid the foundation for pursuing effective basic research by developing novel measuring instruments based on the combinatorial coupling of different technologies. This work has already furthered our understanding of CO<sub>2</sub> reduction significantly and has identified a candidate alloy for producing ethylene from CO<sub>2</sub>. Generating ethylene from CO<sub>2</sub> is particularly promising as ethylene is a key chemical feedstock that has a high commercial value on the global market. Further optimisation with respect to factors such as Faradaic efficiency and overpotential can make this new green synthetic pathway economically competitive compared with conventional production routes. The project also demonstrated that the results achieved and the applicability of the instruments used can be transferred from a model system (copper system / material library) to industrial catalysts. In the final industrial-scale application, these catalyst materials will be used in gas diffusion electrodes. The next step will involve transferring what has been achieved so far using commercial catalysts in the SFC to tests using a cell with gas diffusion electrodes. There are also plans to study other alloying elements, such as silver, gold and nickel. Here, too, the high resolution offered by the SFC-DEMS/SFC-ICP-MS setups in combination with material libraries offers significant advantages over work previously published in the scientific literature. Any non-linear relationships between product distribution and material composition can therefore be identified reliably. The ICP-MS setup enables the stability of the cathode, where CO<sub>2</sub> reduction occurs, and the anode, where oxygen evolution occurs, to be examined. The oxygen evolution reaction is not only important in the CO<sub>2</sub> reduction process, it is also a commonly used counter reaction but one in which the anodic potentials cause stability problems even when noble metals are used. In addition to the direct dissolution of the active material, another key factor affecting catalyst stability is the corrosion of the carbon support medium, which can be studied using the SFC-DEMS setup. Given the general relevance of the oxygen evolution reaction, the findings are not only of value for CO<sub>2</sub> reduction studies but are of great interest in numerous electrolytic processes. However, further studies of both model systems and industrial catalysts are required if improved stability is to be achieved without any reduction in catalyst activity. The stability of the cathode is non-critical, at least under the reaction conditions used. If, however, the system is switched on and off frequently, the potentials reached may result in the dissolution of less-noble catalyst components. Failure to take this into account when alloys are used may mean that the long-term functionality of the system cannot be guaranteed. The knowledge accumulated during the project can now be used to examine other candidate CO<sub>2</sub> reduction materials and to improve the efficiency with which potential catalysts are developed. In addition to studying metallic samples, the research will also focus on examining thermally oxidised catalysts. Thermally oxidised copper exhibits a low overpotential but only limited selectivity with

respect to hydrocarbons, while showing high Faradaic efficiency for the production of carbon monoxide. Despite extensive research efforts in the field of CO<sub>2</sub> reduction, no viable electrolysis unit has been implemented so far. The methodology described above facilitates the more rapid examination of candidate catalytic materials and will therefore help to accelerate progress towards achieving an economically viable industrial-scale solution.



# 1.7 COOBAF – Chemical Processes – Collaborative project: CO<sub>2</sub>-based acetone fermentation

BMBF Project FKZ 033RC1105

Project Coordinator: Dr. Joachim Nitz, Evonik Resource Efficiency GmbH

Project Partner: Universität Rostock, Universität Ulm

## 1.7.1 Introduction

For many years, the ABE fermentation process, in which acetone, butanol and ethanol are produced by bacterial fermentation, was the second largest biotechnology production process in the world after the fermentation of sugars by yeast to yield ethanol. The ABE process is based on the bacteria *Clostridium acetobutylicum* and *Clostridium beijerinckii*. These are gram positive, strictly anaerobic organisms. Wild-type *C. acetobutylicum* yields acetone, butanol and ethanol in the approximate ratio of 3:6:1. The precise product ratio achievable depends strongly on the fermentation culture or the substrates used. As a result of ever cheaper chemical means of synthesising acetone and butanol and increasing substrate prices, the ABE process ceased to be used for commercial purposes.

At present, several million metric tons of acetone are produced worldwide each year. Today, acetone is usually produced from propylene and benzene in a petrochemical oxidation process known as the Hock or cumene process. Increasing raw material costs and rising demand has seen the price for acetone rise over the last few years to around € 900 per metric ton.

But with fossil resources becoming ever scarcer, it is clear that new acetone production pathways need to be developed. In the earlier project 'Heterologous Acetone Fermentation (HAF)' (supported by the German Agency for Renewable Resources (FNR) under grant no. 22014807) it was shown that by inserting the genes required for acetone synthesis (*adc*, *ctfA*, *ctfB* and *thlA* from *C. acetobutylicum*) the acetogenic bacterium *Clostridium aceticum* is capable of heterologously expressing acetone (Lederle, 2010: PhD Thesis, Ulm University; Verseck et al., 2007: Patent DE102007052463).

This was the first time that acetone had been generated by fermentation with acetogenic bacteria using CO<sub>2</sub> as the sole carbon source. Acetogens growing lithoautotrophically under anaerobic conditions make use of the Wood-Ljungdahl pathway that leads to acetate production. The pathway

involves the formation of acetyl-CoA as the central intermediate, which is then used as the starting reagent for the desired acetone production.

## 1.7.2 Project description

The aim of the project was to establish a fermentation process for the biotechnological production of acetone using acetogenic microorganisms and carbon dioxide (CO<sub>2</sub>) as the sole carbon source (Figure 22). More specifically, the objective was to use industrial flue gases, which in addition to CO<sub>2</sub> also contain carbon monoxide (CO) and hydrogen (H<sub>2</sub>), in order to produce acetone – a valuable primary material for the chemical industry – via a sustainable and cost-efficient fermentation process.

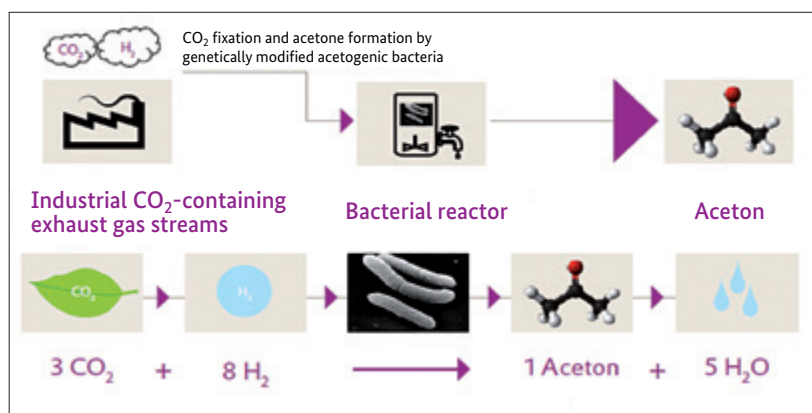

Fig. 22: Schematic representation of the fermentation process in the biotechnological production of acetone with CO<sub>2</sub> as the sole carbon source

The microbial production of acetone using acetogenic bacterial strains and CO<sub>2</sub>-containing flue gas streams has the potential to provide an economical alternative to the petrochemical production route that would also conserve resources and protect the environment.

An important part of this research project concerned the selection of suitable bacterial strains. These strains must be able to tolerate the gas mixture and any toxic components it contains and would, ideally, be able to achieve quantitative conversion of the CO<sub>2</sub>. In contrast to petrochemical raw materials, like propene, or renewable raw materials, such as glucose or saccharose, there is an almost unlimited supply of CO<sub>2</sub> and it is available at significantly lower costs. It therefore seemed possible that even at relatively low levels of productivity, the process could be implemented so as to be economically viable.

The screening and identification of suitable bacterial strains that could accommodate the acetone operon and the introduction of the operon into some of the selected candidates was carried out in the group led by Professor Bahl at Rostock University. The same group also attempted to integrate the acetone operon into the genome. The work packages completed by the Rostock group are listed below:

Work package	WP activities and tasks (Rostock University)
AP 1.1:	Cultivation of bacteria in a gas stream
AP 1.2:	Screening of bacterial strains
AP 1.3:	Cultivation of autotrophic strains
AP 2:	Heterologous autotrophic acetone formation
AP 3.1	Integrating the acetone operon into the genome
AP 3.2	Creating and analysing mutants

The research group led by Professor Dürre from the University of Ulm focused on increasing acetone yield and productivity in the acetone-generating strains using physiological and genetic engineering techniques and on introducing the acetone operon into the remaining selected candidate strains. The work packages completed by the Ulm group are listed below:

Work package	WP activities and tasks (University of Ulm)
AP 4:	Optimisation of acetone synthesis
AP 5:	Transmission of the acetone synthesis gene
AP 6:	Sequencing of <i>C. aceticum</i>
AP 7:	Strain development

At Evonik Industries AG project work focused on developing the fermentation process itself. This included characterising the most important parameters (e.g. pH, temperature) that influence the formation of the product and co-products and developing an appropriate fermentation model. In addition to developing the fermentation process at the lab scale, work was also undertaken to develop a cost- and yield-optimised acetone workup procedure. The work packages completed by at Evonik Industries AG are listed below:

Work package	WP activities and tasks (Evonik Industries AG)
AP 8:	Developing and establishing analytical methods; Setting up the experimental equipment
AP 9:	Development of the fermentation process
AP 10:	Downstream process development

### 1.7.3 Results

#### Rostock University

Both heterotrophic and autotrophic cultivation experiments were performed on 39 different acetogenic bacteria in 25 different media at temperatures between 20 °C and 65 °C. Combined analysis of the autotrophic biomass-specific and volumetric acetate productivities reduced the number of strains studied to 15, of which seven were ultimately identified as strains that may in future be viable systems for the heterologous expression of acetone. These strains were transformed with a variety of plasmids, and subsequent gas chromatographic analyses demonstrated proof of principle for the production of acetone from a number of different strains under conditions of heterotrophic cultivation.

It is therefore in principle possible to cultivate acetogenic, and even thermophilic bacteria, as CO<sub>2</sub>-consuming acetone producers. However further research is required before the technology is mature enough for use in an industrial production environment. One example of the need for continued research was the realisation that both plasmid stability and plasmid detection in the strains under study were inadequate.

#### University of Ulm

The genome of *Clostridium aceticum* has been fully sequenced and annotated. The genome comprises 4.2 megabase pairs with 35 % GC content and contains 3984 genes.

During the project, a total of 20 acetone synthesis operons and plasmids were produced that were optimised for acetogenic bacteria. These were introduced into the acetogenic bacteria *Acetobacterium woodii* and *Clostridium ljungdahlii* by vector transformation. A total of 22 different recombinant *A. woodii* strains and eight different recombinant *C. ljungdahlii* strains were produced for acetone production. The uncontrolled batch experiments using a gas mixture of hydrogen and carbon dioxide as the energy and carbon source yielded a maximum of 20.6 mM (i.e. 1.2 g/l) of acetone.

## Evonik Industries AG

An experimental setup was created at Evonik to work with strictly anaerobic microorganisms and the equipment was scaled up from initial shake flask experiments to a two-litre stirred reactor. As part of the fermentation development work, substrate limitation and product inhibition effects were studied and on the basis of those findings a lab-scale, three-stage continuous fermentation process with cell retention was designed and built. At the same time, studies were carried out to optimise the growth media and this led to a four-fold increase in the amount of acetone produced. Over the course of the project, acetone productivity was boosted by a factor of about 1000 up to more than 0.1 g/(l·h).

A three-stage workup process was developed to enable the acetone product to be separated from the fermentation broth. The acetone was removed from the fermentation broth while fermentation was ongoing by (in situ) stripping with the feed gas as this ensured that product formation would not be inhibited by high acetone concentrations. The next step in the workup process involves absorptive extraction of the acetone from the exhaust gas stream, which is followed by distillation to separate the acetone, co-products and the absorbent. The workup process has a yield of greater than 95%, it is cost-effective, it can be easily scaled up, and the product fulfils the quality specifications that need to be met in order for the acetone to be used in further chemical conversion processes.

### 1.7.4 Exploitation, commercialisation and dissemination of results

Over the course of the project it was shown that a number of different acetogenic bacterial strains that had been modified by the insertion of genes required for acetone synthesis were able to produce acetone from CO<sub>2</sub> and H<sub>2</sub> under anaerobic conditions. As the acetone was produced via bacterial fermentation using CO<sub>2</sub> as the sole source of carbon, this suggests that it will be possible to generate acetone in a cost-effective and resource-friendly way by utilising industrial waste gas streams containing CO<sub>2</sub> and H<sub>2</sub>. The work on microbial acetone production carried out within this fundamental biotech research project is highly relevant today and represents an excellent basis for establishing a sustainable industrial process in future.

In contrast to alternative sources of carbon from renewable raw materials, such as glucose or saccharose, CO<sub>2</sub> from industrial flue gases is available in almost unlimited supply and can be supplied at significantly lower cost. As the feedstock materials used (CO<sub>2</sub> and H<sub>2</sub>) are gaseous substrates, it would be possible to feed the gases repeatedly through the fermenter so that an

economically feasible process could be established despite relatively low productivity. An effective downstream workup process was also developed successfully.

The quantities of acetone produced from CO<sub>2</sub> and H<sub>2</sub> by fermentation increased significantly over the three-year project period. A continuous laboratory fermentation setup was able to generate acetone at a productivity level of more than 0.1 g/(l·h) over a prolonged period.

In view of current market prices for acetone, CO<sub>2</sub> and H<sub>2</sub> and the ongoing fall in the price of oil-based products, the biotechnological process developed for microbial acetone production does not, at present, represent an economically viable alternative to the existing petrochemical procedures in which acetone is produced from benzene and propane. In addition to market prices for acetone, CO<sub>2</sub> and H<sub>2</sub>, other factors that have a key effect on the cost efficiency of this kind of alternative acetone production process are the process yields, the product concentrations and the productivity that can be achieved using acetogenic microorganisms.

The results obtained in this project indicate that the bacterial strains need to be optimised further in order to boost productivity sufficiently so that the overall process is economically viable at the industrial scale. This type of bacterial strain development work would typically require at least three more years of research. Once the bacterial strains have been optimised, the microbial acetone production process would need to be expanded to industrial production levels, which would involve the systematic scale-up of the process from the laboratory to a mini-plant setup in a technical centre and, finally, a pilot plant capable of producing several thousand metric tons of acetone.

# 1.8 DMEexCO<sub>2</sub> – Integrated dimethyl ether synthesis from methane and CO<sub>2</sub>

BMBF Project FKZ 033RC1108

Project Coordinator: Dr. Ekkehard Schwab, BASF SE

Project Partner: hte, Linde, Fraunhofer Umsicht, Max-Planck-Institut für Kohlenforschung GmbH, Technische Universität München

## 1.8.1 Introduction

Dimethyl ether (H<sub>3</sub>C-O-CH<sub>3</sub>, DME, methoxymethane) is the simplest ether. Its physical properties are similar to those of liquefied gas (LPG – typically a mixture of propane and butane). As DME burns cleanly it, like LPG, is used in large quantities in Asia as an indoor fuel. DME is also used as a CFC-free aerosol propellant.

At present, DME is produced using an indirect, two-step synthesis via methanol as an intermediate. So far, all commercial production units have used this synthetic route. The DME synthesis step can be considered to be an add-on to existing methanol production plants with the result that the DME produced via this route always exhibits higher production costs than methanol. The price coupling associated with the conventional two-step synthesis of DME via methanol could be avoided if DME could be synthesised directly. Methanol is produced via reactions (1) and (2):



Subsequent dehydration (3) of the methanol produces DME:



Methanol is produced at pressures significantly above 50 bar and at temperatures in the range 200–300 °C. The dehydration process typically occurs at temperatures above 300 °C and at pressures of 10–20 bar. The single-step synthesis of DME is known to take place at a pressure of about 50 bar and a temperature of around 250 °C, but has not so far been implemented on a commercial scale.



The direct synthesis of DME from synthesis gas ('syngas') was addressed in this collaborative project in which both the formation of methanol from syngas and its subsequent dehydration to DME are carried out in a single reactor (see Equations (4) and (5)). A significant difference between the single-step and two-step synthesis routes (and one that is highly relevant in terms of process design and heat integration) is the position of the thermodynamic equilibrium in the syngas/MeOH/DME system (see Figure 1). Under identical reaction conditions, the equilibrium is located significantly further towards the product (i.e. DME) side of the reaction when the direct (single-step) synthesis route is taken.

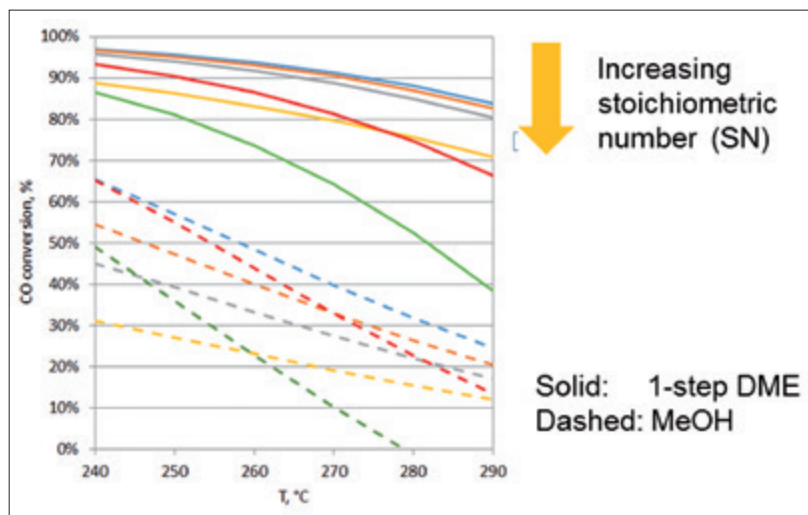

Fig. 23:  
Equilibrium conversion for  
DME synthesis via methanol  
and single-step DME synthesis  
as a function of the stoichiometric  
number SN ( $SN = (H_2 - CO_2)/(CO + CO_2)$ )

## 1.8.2 Project description

The goal of the project was to develop a catalyst system and to design an associated process that would enable the direct (i.e. single-step) heterogeneously catalysed synthesis of DME from CO-rich syngas that may also contain CO<sub>2</sub>. In addition to its main objective of developing a direct DME synthesis route, the project also aimed to achieve material and energy integration for the syngas and DME synthesis stages in order to optimise the energy efficiency and minimise the climatic impact of the overall process. The reforming stage that generates the syngas did not, however, form part of the project.

The direct synthesis of DME from syngas was addressed in this collaborative project in which both the formation of methanol from syngas and its subsequent dehydration to DME were carried out in a single reactor (see Equations (4) and (5)).

The overall reaction equation for the direct synthetic route depends on the H<sub>2</sub>/CO ratio and can be represented by the following two limiting cases:

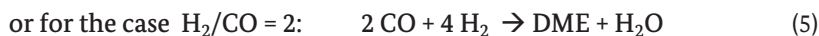

The varying composition of the syngas feedstock with respect to the quantities of hydrogen, carbon monoxide and carbon dioxide that it contains can be described by an index known as the stoichiometric number (SN):

$$\text{SN} = (\text{H}_2 - \text{CO}_2)/(\text{CO} + \text{CO}_2) \quad (6)$$

An important part of the project was the continuous sharing of information and ideas between the teams working on catalyst and process development. The objective was not to develop the best catalyst and the best process independently of one another, but rather to identify the optimum combination of both. This involved regularly sharing knowledge about relevant parameters and discussing how they might affect catalyst development and process design respectively. This approach optimised the developmental path taken and allowed each development team to provide efficient and targeted support to the other.

Catalyst development was undertaken jointly with hte and BASF. In the light of previous catalyst development work in this field, particular focus was placed on achieving a significant improvement in the long-term stability of the catalyst system without surrendering catalyst activity and selectivity targets. Catalyst development took place in several stages. On the basis of a working hypothesis regarding the chemical functionality required by the catalyst system, a comprehensive high-throughput screening programme was carried out at hte. The screening programme involved iterative variation of both catalyst composition and operating parameters. The result of the screening campaign was a catalyst that met the specified activity and selectivity targets whilst also fulfilling the minimum stability criterion. The catalyst system identified in this way was then fabricated in a variety of technically relevant shapes and subjected to long-term testing. The testing was carried by both BASF and Linde in new test reactors in which the shaped catalysts could be studied. The test data enabled detailed conclusions to be drawn concerning the deactivation mechanism and allowed the catalyst recipe to be adjusted accordingly.

The goals of the Linde work package in the first year of the project were to work closely with the Technical University of Munich (TUM) to develop the process design concept for the single-stage DME synthesis (including comparisons with conventional routes) and to make progress on integrating the

syngas generation and DME synthesis stages. The results of that work package were used by the project partners to jointly agree milestones and performance criteria for subsequent catalyst development work. In addition, the conceptual engineering phase for the lab-scale plant and the miniplant (technical centre) was also initiated at this time.

In the second year of the project, the process design work focused on workup procedures for the DME product and on evaluating a number of different recycling options. A differential reactor for the experimental kinetic studies was made available at this stage and the planning, procurement and construction of the miniplant in the technical centre was completed. During year two of the project and before the two cost-intensive miniplants were commissioned at BASF and Linde, the project partners all gave positive assessments of the agreed milestones regarding the energy efficiency of the process, CO<sub>2</sub> emissions savings and catalyst performance.

In the third year of the project, the knowledge acquired thus far was used to optimise and validate the process with the help of detailed process simulations. A series of experiments were conducted in the differential reactor in order to describe the kinetics of the catalyst system. During a number of the experimental campaigns at Linde the miniplant was operated continuously.

While project work was being undertaken at the two industrial partners, the research team led by Professor Ferdi Schüth at the Max Planck Institute for Coal Research examined the deactivation mechanism and tested a number of alternative catalyst recipes. The results of the mechanistic studies were used to fine-tune the catalyst recipe towards the latter end of the project.

Another work package that was carried out at the same time concerned benchmarking the fixed bed reactor design preferred by the project partners against the slurry-type reactor that has been the only type of reactor to be described so far in the scientific literature. A new test plant was therefore

Fig. 24:  
Pilot reactor setups at BASF (left)  
and Linde (right)



built at the Fraunhofer Institute for Environmental, Safety and Energy Technology (UMSICHT), which began operating during the second half of the project. The benchmarking study showed that a fixed-bed reactor is likely to be superior to a slurry reactor.

### 1.8.3 Results

The work carried out at hte and BASF yielded a catalyst system that for the first time is capable of achieving the minimum service life of one year required of catalysts used in industrial applications (Fig. 24). The catalyst system can also be fabricated in the quantities needed in industrial applications

As part of their work on process development and integration, TUM and Linde conducted an evaluation of the overall process from which they deri-

Fig. 25:  
Continuous improvement  
in catalyst stability  
(Generations A, B and C)

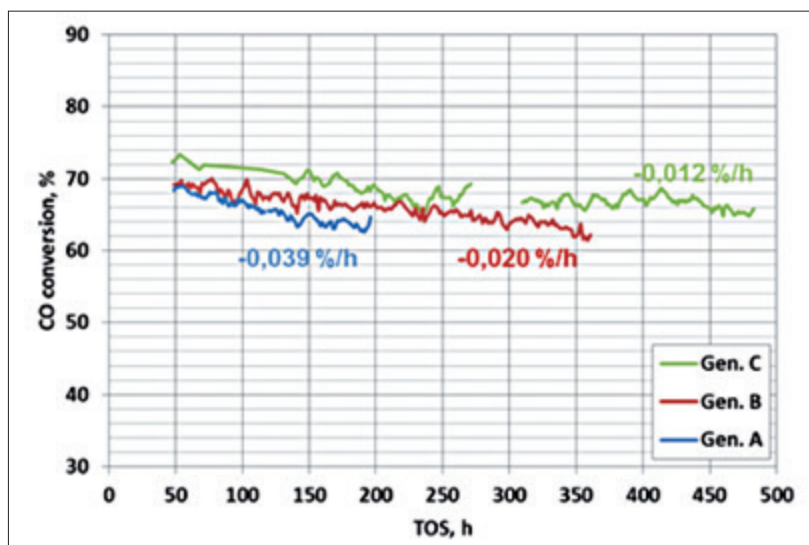

ved catalyst development targets. An important component of the evaluation was using detailed simulation studies to benchmark the single-step process against the conventional two-step DME synthesis. A new concept was introduced for the direct DME synthesis that involved material and energy integration of the syngas production and the DME synthesis stages. A new separation sequence for purifying the DME product was also developed. Following further optimisation of the process, the final concept of direct DME synthesis that had been developed over the course of the project resulted in a significant increase in process efficiency and a reduction in carbon emissions of more than 30%. Using both integral and differential reactors multiple series of experiments were carried out to characterise the kinetics of the new catalyst system. The experimental data provides the basis for a kinetic

model of the catalyst, which is necessary if the reactor is to undergo successful industrial scale-up.

The project succeeded in demonstrating that replacing the current two-step production of DME (via methanol) with the direct DME synthesis process developed during the project results in a reduction in carbon emissions of 30%. The new process also yields competitive benefits thanks to energy efficiency improvements of around 10%, which are also reflected in the positive rating of the economic viability of the new process.

Fig. 26:  
Benchmarking of the conventional (two-step) versus the new one-step process

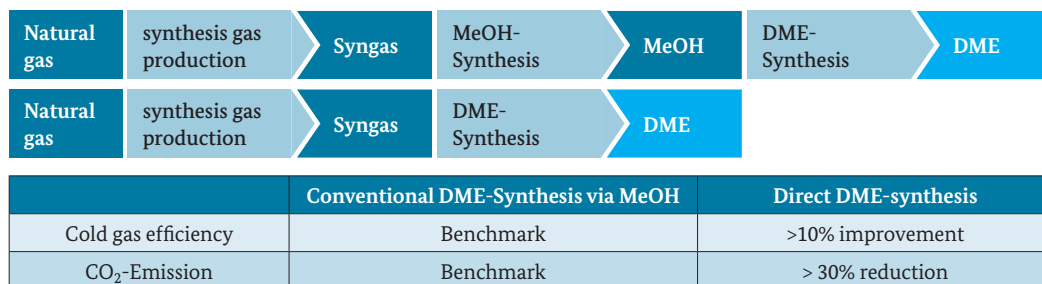

## 1.8.4 Exploitation, commercialisation and dissemination of results

In this collaborative project, a process for synthesising DME was developed that exhibits technological and commercial advantages when compared to the process currently used. Increasingly, DME is being added to LPG to produce LPG/DME blends. DME may also acquire a future share of the market in diesel fuels. The advantages of DME are principally due to the fact that it exhibits better combustion properties (including emissions) compared to pure LPG and diesel. Commercial exploitation of DME will depend on the prevailing regulatory conditions and on market competitiveness. The project has demonstrated that DME is economically competitive by decoupling the cost of DME production from the price of methanol. Building on the development work in the project, a pilot phase will need to be carried out prior to any future commercialisation.

Current forecasts show a slightly smaller growth rate for the DME market than was the case at the beginning of the project in 2011; the growth rate is, however, significantly above average growth rates. The sizeable investment required for new plants represents a significant opportunity for process plant construction companies and for catalyst manufacturers.

The goal of the industrial project partners remains that of continuing to develop the direct synthesis of DME in partnership with others and to commercialise the results if positive.

# 1.9 Dream Polymers

## BMBF Project FKZ 033RC1104

Project Coordinator: Dr. Christoph Gürtler, Covestro

Project Partner: Bayer Technology Services, RWTH Aachen, Leibniz-Institut für Katalyse e.V., Fraunhofer ITC

### 1.9.1 Introduction

The 'Dream Polymers' project examined a wholly new approach to synthesising polyols that has the potential to produce polyols using only alternative raw materials. The idea is to react formaldehyde and CO<sub>2</sub> to form polyols. The low molecular weight polyols are processed to produce polyurethanes, while the high molecular weight compounds are used directly as polyoxymethylene (POM) thermoplastics. This creates an additional possible use of polyols in the form of a new marketable polymer. If the proposed new synthetic pathway is implemented successfully, it would generate CO<sub>2</sub> emissions savings of about 1.6 million metric tons of CO<sub>2</sub> per year.

#### **Pre-project status and background:**

##### **Use of CO<sub>2</sub> in polyurethanes**

Polyurethanes (PUs) are among the most important products manufactured by the chemical industry. Manufacturers included Bayer, BASF, DOW and Huntsman. The size of the global market is currently around 12 million metric tons per year, with polyurethanes being produced from isocyanates and polyols. The use of CO<sub>2</sub> as a chemical building block has not so far played a part in the synthesis of the PUs currently available commercially.

##### **Use of CO<sub>2</sub> in polyoxymethylene (POM)**

Polyoxymethylene (POM) is an engineering plastic. It known commercially by a variety of names such as Delrin (Dupont), Ultraform (BASF) or Celcon (Ticona). Its most important properties are: (I) high strength and high rigidity, (II) good resilience, (III) excellent chemical resistance, (IV) dimensional stability, (V) low water uptake, (VI) low creep and (VII) outstanding dynamic friction properties. POM can generally be machined on all equipment used to process thermoplastics. The global market in POM totals around 0.9 million metric tons per year. So far, CO<sub>2</sub> has not been used as a chemical feedstock in the production of POM.

##### **Polymethylene carbonate polyols**

The first fundamental results relating to polymethylene carbonate polyols were described in two publications in the scientific literature.<sup>1,2</sup> The authors

claim to be able to synthesise alternating polymethylene carbonate polyols from tertiary amines and an aqueous formaldehyde solution or a suspension of polymeric paraformaldehyde in organic solvents with dry ice as the CO<sub>2</sub> source. At temperatures from 120 °C to 175 °C, reaction times ranging from 12 hours to 5 days were required to achieve the maximum yield of 39% of product. The details published about the structures of the co-oligomers produced and the synthetic routes need to be re-examined and assessed. Furthermore, the space-time yields achieved are inadequate for industrial applications. The physical properties and the chemical stability of the products are only partially described in the publications. The 'Dream Polymers' project therefore aimed to develop a process that would enable polymethylene carbonate polyols to be produced with space-time yields suitable for industrial applications.

### Formaldehyde

Formaldehyde is available as a monomeric gas in industrial quantities and its properties are well established in the scientific literature.<sup>3,4,5</sup> However, because of its very high propensity to undergo polymerisation, monomeric formaldehyde is difficult to store and transport and is generally only available locally. In the laboratory environment, formaldehyde is commonly used either in the form of an aqueous solution, or the linear polymer paraformaldehyde or the trimer trioxane. Paraformaldehyde is a short-chain polymer of formaldehyde. Paraformaldehyde depolymerises to form monomeric formaldehyde in the presence of water or acids or when heated. Trioxane represents the least reactive form of formaldehyde. High temperatures (150–200 °C) are needed for the thermal dissociation into formaldehyde. If aqueous formaldehyde solutions or paraformaldehyde are to be used in chemical reactions certain requirements need to be met, e.g. water and/or methanol-tolerance, suitable conditions for the depolymerisation of paraformaldehyde, suppression of undesirable side reactions, etc.

## 1.9.2 Project description

The research project was concerned with the chemical conversion of CO<sub>2</sub> using formaldehyde in order to provide access to polymethylene carbonate polyols synthesised completely from molecular building blocks that have themselves been generated either directly or indirectly from CO<sub>2</sub>. Low molecular weight variants of these newly synthesised substances were tested for their suitability to be processed into polyurethanes, while the high molecular weight species were studied as polyoxymethylene (POM) thermoplastics.

The project was split into five work packages to be carried out by the respective project partners. Work Package 1 (WP1) 'Primary Materials' described the



preparation and supply of the CO<sub>2</sub>, the initial polymerisation experiments involving reactive formaldehyde and CO<sub>2</sub> and the subsequent analysis of the chemical kinetics and the reaction parameters. The focus in Work Package 2 (WP2) 'Reaction' was on conducting a broad catalyst screening campaign aimed at identifying metal-based Lewis acid catalysts and nucleophilic organocatalysts that could serve as potential candidates for synthesising low molecular weight and high molecular weight polymethylene carbonate polyols. The online and ex situ datasets on the reaction profile and reaction kinetics formed the basis for Work Package 3 (WP3) 'Process' in which they were combined with empirical physicochemical data in order to develop a number of reactor concepts for the proposed polymerisation, to design an experimental plant and to conduct simulations for possible later scale-up. In Work Package 4 (WP4) 'Materials' sample quantities of the polymethylene carbonate polyol product were converted to polyurethanes and the mechanical and rheological properties were characterised with respect to its potential role as a POM alternative. Work Package 5 (WP5) 'Accompanying measures' ran for the duration of the entire project and included a life cycle analysis (LCA) and an examination of the value chain. An overview of the component work packages that made up the collaborative project is shown in Figure 27.

Abb. 27:  
Work packages in the  
'Dream Polymers'  
collaborative project.

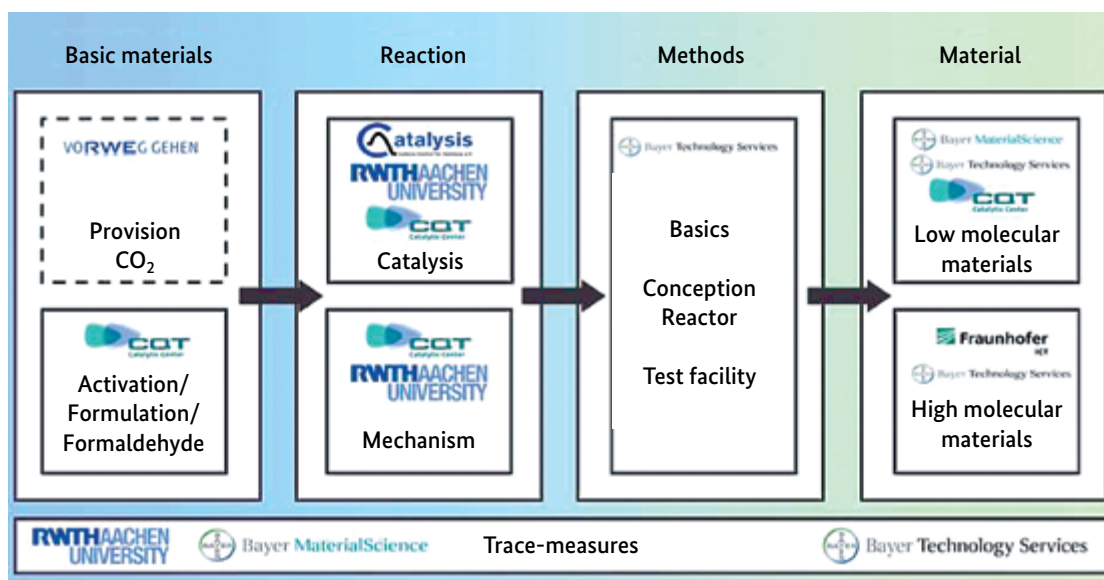

## 1.9.3 Results

### 1.9.3.1 Development of catalysts for the copolymerisation reactions with CO<sub>2</sub> and formaldehyde

A concept was developed that allowed the direct copolymerisation of formaldehyde with CO<sub>2</sub> by incorporating the CO<sub>2</sub> into a growing polyformal chain. CO<sub>2</sub>-containing formaldehyde block copolymers based on CO<sub>2</sub>-containing polyethers were also developed. Furthermore, methods were established that enable gaseous formaldehyde to be copolymerised with epoxides. Statistical polymers were produced via statistical copolymerisation of formaldehyde with epoxide using a polyol starter; sequential polymerisation yielded block copolymers.

### 1.9.3.2 Developing methods for stabilising copolymers based on formaldehyde and CO<sub>2</sub>

An endcapping procedure for stabilization and OH functionalization with propylene oxide (PO) was developed to produce stable formaldehyde copolymers. Both homopolymerization of formaldehyde in the presence of a starter and endcapping must be performed at temperatures below 60 degrees Celsius to avoid thermal degradation of the POM blocks formed prior to the endcapping step. The double metal cyanide (DMC) catalyst initially used for endcapping with PO exhibits insufficient activity in this temperature range. Lewis acids were found as alternative catalyst systems, which exhibit high activity for the homopolymerization of propylene oxide even at 60 degrees Celsius.

### 1.9.3.3 Optimisation of the catalytic methods

Several new methods for generating polymers from formaldehyde sources were developed over the course of the project. Similarly, compatible methods for stabilising the synthesised products were also discovered. In addition, alternative methods were found that provide routes to stable and previously inaccessible multiblock formaldehyde polyether diols. The copolymers generated were used to produce formaldehyde-based polyurethanes that exhibited thermoplastic properties. The fraction of sustainable components in these materials was as high as 42 % by weight.

### 1.9.3.4 Material properties of the products

The novel formaldehyde-containing polyols can react with isocyanates to form polyurethanes. The properties of these new materials were examined and it was shown that their thermal and mechanical properties and their resistance to environmental factors are similar to those of conventional polyurethane films.

The thermoplastic polyurethanes generated from the novel polyols were also examined to determine their suitability for extrusion processing. It was demonstrated that the polyurethanes formed from the block copolymers (CO<sub>2</sub>/PO-formaldehyde-CO<sub>2</sub>/PO) behave very much like thermoplastic polyurethanes (TPUs).

#### 1.9.3.5 Life cycle assessment of the products

Incorporating 20 % by weight of CO<sub>2</sub> reduces CO<sub>2</sub> emissions by around 17 %. This result was already known from the preceding project 'Dream Production'. The inclusion of 24 % by weight of formaldehyde as a substitute for propylene oxide, which was examined in the present project, resulted in an equally advantageous reduction in CO<sub>2</sub> emissions of 18 %. By combining these results, i.e. using CO<sub>2</sub> (16 %) and formaldehyde (21 %), CO<sub>2</sub> emissions savings of up to 30 % can be achieved. In any industrial implementation of the polyol syntheses examined in this study, the presence of a nearby concentrated source of CO<sub>2</sub> would be particularly beneficial.

### 1.9.4 Exploitation, commercialisation and dissemination of results

The overall objective of the research project was to utilise CO<sub>2</sub> as a C<sub>1</sub> building block in the conversion of formaldehyde to produce polymethylene carbonate polyols. The project aimed to establish the principles governing the incorporation of CO<sub>2</sub> and formaldehyde into polyols and to identify new research directions and encourage new developments in the field of renewable raw materials in industrial polymer manufacture. The results from the project have significantly strengthened Germany's position as a technology hub, particularly the market competitiveness of companies operating in areas involving renewable raw materials.

#### Scientific and research prospects

The research work carried out in the project yielded major advances in the production of formaldehyde-based polymers. Of particular note in this regard is the development of novel formaldehyde copolymers that can be converted to a range of different polyurethanes. As segments with different crystallisation propensities can be combined, this opens up the possibility of designing previously unknown polymer architectures. Important new results were also obtained regarding the polymerisation and copolymerisation of 1,3,5-trioxane. Additionally, methods for copolymerising 1,3,5-trioxane with acid anhydrides were also developed that have not so far been studied scientifically. Extensive kinetic studies with in situ analyses were conducted that yielded new insights into the mechanistic details of the cationic polymerisation of trioxane.

All results of scientific and technological value have been published in the relevant scientific journals or are currently being prepared for publication. A number of Diplom and Master's research theses were completed over the course of the project. The results were also presented at national and international conferences. The results generated by the project will be used as the basis for further research and collaborative projects. The 'Dream Polyols' project will conduct research based on results obtained from the 'Dream Polymers' project.

### Economic prospects

The novel polyols can be converted into polyurethanes whose properties are similar to those of polyurethanes manufactured from purely fossil-based feedstock materials. The German Federal Ministry of Education and Research (BMBF) also funded the 'CO<sub>2</sub>RRECT' project that was concerned with the development of isocyanates from alternative raw materials. Combining the results of that project with those of the present project indicates the possibility of synthesising novel polyurethanes from starting materials that are predominantly renewable. Furthermore, the polyols studied in the project have significant potential for applications in the field of thermoplastic polyurethanes (TPUs). Transferring results from the 'Dream Polymers' project to other materials is planned and this should enable the results to be exploited in future work, such as in the 'Dream Polyols' project.

### References:

- 1 W.-Y. Chiang, *Tatung Xuebao* **1978**, 255-265.
- 2 R. K. Sharma, E. S. Olson, *Preprints of Symposia – American Chimica* **2000**, 676-680.
- 3 F. S. Dainton, K. J. Ivin, D. A. G. Walmsley, *Trans. Faraday Soc.* **1959**, 61-64.
- 4 E.-U. Köcher, K. Wagner, K.-L. Schmidt, K. Klinkmann, DE 1167807; F. Zumstein, E. Assmann, R. Koenigsberger, DE 1172657.
- 5 K. Runge, R. Mayer, *Liebigs Ann. Chem.* **1967**, 707, 161-162.

# 1.10 FfPaG – Solid and liquid products from gases

BMBF Project FKZ 033RC1301

Project Coordinator: Andreas Bode, BASF New Business GmbH

Project Partner: TU Dortmund, BASF SE, Linde AG, ThyssenKrupp Industrial Solutions AG, ThyssenKrupp Steel Europe AG, hte GmbH, VDEh-Betriebsforschungszentrum GmbH

## 1.10.1 Introduction

Many raw material resources are in short supply and are becoming even more scarce, energy and raw material prices vary significantly around the world and change with time, and there is increasing focus on reducing global levels of CO<sub>2</sub> emissions. In the light of these constraints, companies that compete globally in resource-intensive industries need to develop new process technologies. The FfPaG project shows that cross-sectoral cooperation can lead to the discovery of new approaches and new directions in process technology and process engineering with the potential to assist the transition to new sources of raw materials, to reduce CO<sub>2</sub> emissions, boost CO<sub>2</sub> utilisation and drive market competitiveness.

Hydrogen, synthesis gas and carbon are and will continue to be major raw materials and basic chemical building blocks for the steel, aluminium, petrochemical and chemical industries. Hydrogen and carbon dioxide can be converted to synthesis gas, providing an interface to existing petrochemical processes that are used to produce important chemicals, such as methanol, dimethyl ether or Fischer-Tropsch products. However, chemically converting CO<sub>2</sub> and hydrogen to syngas will only result in a reduction in CO<sub>2</sub> emissions if the hydrogen itself can be generated via a low-carbon process.

Current methods of achieving low-carbon hydrogen production, e.g. by electrolysing water using electricity from renewable energy sources, are limited by the small size of the plants and the high costs involved. Due to the large quantities of hydrogen required, biomass gasification is also unsuitable as a means of generating low-carbon H<sub>2</sub>. Other processes are still at an early stager of development <sup>[1]</sup>.

The method of hydrogen production chosen for the FfPaG project was the pyrolysis of methane or natural gas. The pyrolysis reaction is the thermal dissociation of methane to hydrogen and solid carbon. Methane pyrolysis has been the subject of study for many decades. The numerous reaction pathways (catalysis, thermal catalysis, plasma) have been examined and the questions

of CO<sub>2</sub> reduction and the different uses for the carbon product have been addressed [2,3]. Apart from plasma pyrolysis, which yields carbon in the form of soot, the pyrolysis plants currently used are all lab-scale facilities. Plasma pyrolysis is not an option for the FfPaG project as soot is not a suitable raw material for metallurgical applications, and a number of technical and economic disadvantages would be expected if plasma pyrolysis were used.

Benefits of producing carbon by the pyrolysis of methane are that the carbon product is ash-free and does not contain unwanted components such as alkalis or sulfur- and phosphorus-containing compounds. The fine granular carbon produced is therefore suitable as a replacement for coking coal or for the pulverised coal used in the steelmaking industry. Other possible uses of the solid carbon products are in aluminium smelting and other industrial sectors. This innovative approach of using solid carbon from natural gas pyrolysis in metallurgical applications requires inter-sector collaboration in both research and the subsequent commercialisation of the results.

### 1.10.2 Project description

The aim of the project is to develop a pilot plant concept for a new type of production process in which solid and liquid products are formed from

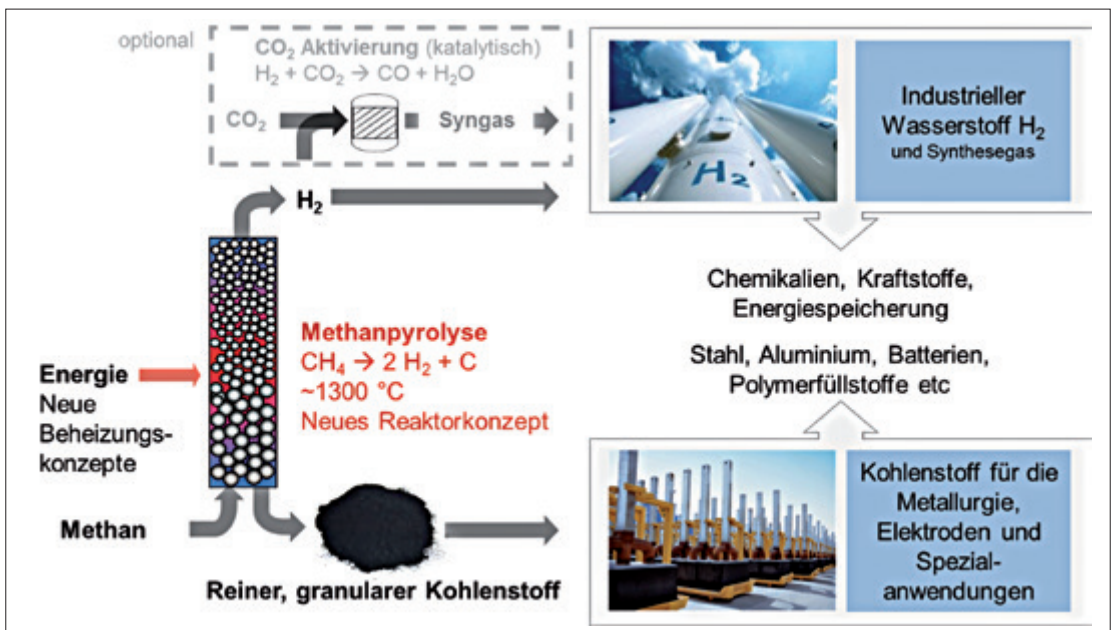

Fig. 28: Overview of the FfPaG project and its constituent stages: methane pyrolysis, catalytic CO<sub>2</sub> activation by the reverse water-gas shift reaction (RWGS), and the production and control of the granular carbon (upper photo: Linde AG; lower photo: Anodes, Dubai smelter, Dubai UAE, Source: International Aluminium Institute – by kind permission of Emirates Global Aluminium)

gases (FfPaG). The process comprises the pyrolysis of natural gas to form hydrogen and granular carbon, the catalytic conversion of the hydrogen and CO<sub>2</sub> to produce syngas (CO<sub>2</sub> activation) and controlling the size and morphology of the carbon product. The hydrogen, whether generated directly from pyrolysis or after CO<sub>2</sub> activation to form syngas, can be utilised by the chemical industry and for the production of transport fuels. The granular carbon can be used as a high-quality feedstock for a variety of applications in the coke and steel production sectors, as well as for other metallurgical processes.

Figure 28 shows the new process and the component stages: methane pyrolysis, production and control of the granular carbon, and catalytic CO<sub>2</sub> activation via the reverse water-gas shift reaction (RWGS).

The granular carbon can be used as a substitute for coal in coking plants and in blast furnaces, or as replacement for petroleum coking the aluminium smelting industry – all of which lead to an improvement in the carbon footprint of the overall process. Global demand for coking coal is estimated at approximately 1 billion metric tons per year – the largest single industrial use of carbon. The fabrication of anodes for use in the aluminium industry accounts for a further 25 million metric tons of carbon annually. Global annual demand for hydrogen and syngas is around 60 million metric tons and 220 million metric tons respectively. Methane pyrolysis yields carbon and hydrogen in a mass ratio of 3:1 so that sufficient quantities of carbon could be produced for other applications provided that the carbon can be produced at a high enough level of purity. The successful commercial implementation of the process will depend on the site-dependent levels of

Fig. 29: Sankey diagrams (qualitative) for visualising the carbon footprints for the combined methane-steam reforming and coking plant process using the best available technology (left) and for the new FfPaG concept (right).

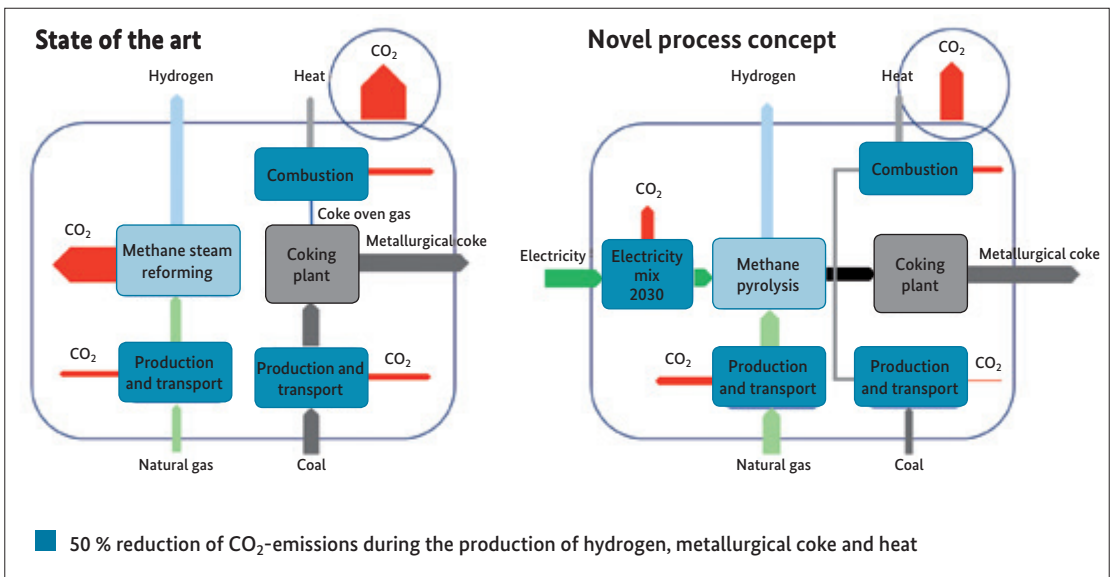



investment required, the operating costs and the income from selling the hydrogen and carbon produced.

If the endothermic pyrolysis reaction can benefit from optimised heat integration, the reduction in CO<sub>2</sub> emissions compared with the conventional method of hydrogen production from the steam-methane reforming process is about 50 %<sup>[1]</sup>. The Sankey diagrams in Figure 29 provide a qualitative representation of the results of computing the carbon footprint (comparison of CO<sub>2</sub> emissions) for the conventional process using the best available process technology and for the new FfPaG concept. The process boundaries are shown by the rounded rectangular frames and the CO<sub>2</sub> emissions across the process boundaries are represented as circles.

If the FfPaG process is to be successfully implemented in practice, research work will be required in the following areas:

- High-temperature reactor technology with heat integration: Design of an optimally energy-integrated reactor for the pyrolysis of natural gas to yield hydrogen and carbon
- Heating technology for the endothermic pyrolysis of natural gas in a gas-solid reactor
- Studying the coupled momentum, thermal and mass transport processes with reaction in the gas-solid system: Ensuring that the carbon structures being produced do not pose a toxicological hazard by optimising the process conditions, particularly temperature and residence time
- Creation of a carbon product whose physical and material properties are suitable for use in the steel- and aluminium-producing industries, development of the steps necessary to formulate an appropriate carbon product for each specific industrial application
- Catalysts and processes for the RWGS reaction: Development of catalysts with high activity, hydrothermal stability, resistance to sintering and long-term stability
- Process integration of the pyrolysis and CO<sub>2</sub> activation stages: Development of an energy-optimised overall process concept.

The knowledge gained from these research activities will be used to design, dimension and engineer a suitable pilot plant.

### 1.10.3 Results

The planned trial production facilities, with sizes ranging from lab scale to semi-pilot scale, have all been built and are currently in operation. Experimental studies are being carried out in the areas: reaction kinetics, heating technology, heat integration, materials selection and equipment structure and design. Parallel studies aimed at modelling the underlying reactive system (published, for example, in <sup>[4]</sup>) and at simulating the overall technological process have yielded important information for the design of the proposed pilot plant. New information on residence time behaviour, on the required material stability and durability and on measures that can be used to suppress the back reaction go far beyond what has been understood so far and provide an excellent basis for the design of the pyrolysis reactor.

Fig. 30: Test production facilities (lab and pilot scale) for the high-temperature pyrolysis of natural gas; (2014 and 2015)



In order to ensure that the carbon product is suitable for subsequent industrial applications, a specially designed trial batch production facility will be built to manufacture quantities at the semi-pilot scale. The trial batch production facility shown in Figure 30 will be commissioned in 2016. The test batches will be used to examine a range of approaches to solid product workup and processing and to carry out application tests, e.g. coking/ carbonisation experiments. Operating the trial batch production facility will also yield important information about the relationships between key operational parameters such as temperature and residence time and product

Fig. 31: Trial batch facility for the production of batches of carbon for testing; (2016)



properties under technically relevant conditions – information that will be critical in designing and constructing a pilot plant. In terms of its physical dimensions and the proposed quantities of carbon that it will produce, the trial batch production facility is the largest known non-plasma methane pyrolysis plant. The quantities of the carbon product samples that can be produced are large enough for reliable tests to be carried out in the metallurgical industry.



Fig. 32:  
Test facilities for developing catalysts for use in the reverse water-gas shift reaction for CO<sub>2</sub> activation; (2014 and 2015)

To facilitate integration into the overall pyrolysis process, the work on developing a catalyst for the CO<sub>2</sub> activation stage and on the associated reactor design issues focused on achieving a catalyst formulation that exhibits good overall performance, both in terms of chemical conversion and selectivity, and that is stable over the long-term. The test facilities for developing the catalytic CO<sub>2</sub> activation stage are shown in Figure 31. By the end of 2016, the catalyst development and reactor design work should be at a stage that will allow a pilot plant to be built once a final risk assessment has been conducted. The pilot plant will enable the usual questions regarding scale-up to industrial production levels to be addressed.

The main result of the FfPaG project was the overall process design concept that covers the pyrolysis stage and the workup of the gaseous pyrolysis products. Potential sites will be selected on the basis of both economic and environmental factors. All of the key specifications and requirements for dimensioning and building the pilot plant will be set out in a comprehensive design basis. In addition to the core component, the pyrolysis reactor, the design basis will include all the process steps needed in order to physically implement the material flow paths within the overall process. The suitability of candidate sites was also assessed in terms of their industrial integration potential by taking into account their proximity to existing production facilities in the chemical, petrochemical and steel industries.

### 1.10.4 Exploitation, commercialisation and dissemination of results

The research work conducted within the FfPaG project has expanded technical understanding of the thermal pyrolysis of methane and will continue to pursue its objective of compiling a viable design concept for a pilot plant by the end of 2016. The project also aims to achieve the successful operation of a trial batch production facility in order to demonstrate production of pyrolytic carbon by the end of 2016. The catalyst and reactor concept for the CO<sub>2</sub> activation stage is also scheduled for completion by the end of 2016 and will enable the pilot reactor to be integrated with the overall process environment.

The viability of building a pilot plant will depend on the commercial conditions influencing the subsequent industrial use of the two products low-carbon hydrogen and pure granular carbon. At present no decision has been made regarding the construction of the pilot plant.

The new technology will be used within the development consortium, and possibly externally as well, and will be commercialised if market conditions permit. The new technology has allowed the participating companies to consolidate and expand their competitiveness in the hydrogen and syngas markets. The successful development of the technology associated with methane pyrolysis and CO<sub>2</sub> activation will safeguard local jobs in the areas of plant and equipment engineering, the manufacture and sale of appropriate catalytic systems and the supply of the requisite technical and scientific services.

The process will require novel plant engineering and process instrumentation and control technologies that will also be deployable in existing processes and others currently under development. Special solutions will need to be found in the fields of: reactor construction, heating technology, temperature monitoring, feed and discharge systems, plant equipment for processing the granular carbon product. Technical solutions of this kind are often provided by small and medium-sized technology companies that take the opportunity to expand their technology portfolios to meet the ever more challenging requirements of future industrial applications.

The project work conducted in the academic sector incorporates and connects numerous facets of coking technology, iron and steel production, chemical engineering and process technology.

**References:**

- [1] Machhammer et al: Financial and Ecological Evaluation of Hydrogen Production Processes on Large Scale. *Chem. Eng. Technol.* 2016, 39, No. 6, 1185-1193
- [2] Abbas and Wan Daud: Hydrogen production by methane decomposition: A review. *International Journal of Hydrogen Energy* 35 (2010) 1160-1190
- [3] Muradov and Veziroglu: "Green" path from fossil-based to hydrogen economy: An overview of carbon-neutral technologies. *International Journal of Hydrogen Energy* 33 (2008) 6804-6839
- [4] Munera Parra et al: Multiplicity Regions of a Moving-Bed Reactor: Bifurcation Analysis, Model Extension and Application for the High Temperature Pyrolysis of Methane. *Chem. Ing. Tech.* 2016 – accepted for publication

# 1.11 PhotoKat – Developing active and selective photocatalysts for the reduction of CO<sub>2</sub> to form C1 feedstock

BMBF Project FKZ 033RC1007

Project Coordinator: Prof. Dr. Jennifer Strunk, Leibniz-Institut für Katalyse e.V.  
(Project enforcement at Ruhr-Universität Bochum)

## 1.11.1 Introduction

The concept of simply using water and sunlight to transform the greenhouse gas carbon dioxide into fuels and other energy carriers represents an ideal way of reducing the effects of climate change and of boosting the use of sustainable raw materials. Even though this type of sustainable photocatalytic transformation has been extensively studied around the world for more than 30 years, there is no system known at present that can produce the volumes necessary for it to be a viable industrial process. For example, methane production yields typically do not exceed  $10 \mu\text{mol gcat}^{-1} \text{h}^{-1}$ <sup>[1]</sup>. Attempts to control selectivity in order to encourage the production of certain products such as methanol or longer chain hydrocarbons have also proved unsuccessful. Many of the publications in this field do not study the full spectrum of products, choosing instead to focus on the formation of the main product over time.

One possible reason why yields have not improved significantly over time may be due to the lack of systematic studies. There are also significant differences in the reaction conditions and catalysts used in the published studies, which makes it very difficult to make meaningful comparisons. Furthermore, many materials have not been studied in detail with the exception of titanium dioxide-based photocatalysts. For example, despite the fact that zinc oxide (possibly in mixtures with gallium oxide or gallium nitride) has a surface that appears ideally suited to activating CO<sub>2</sub> by forming carbonates, there are almost no studies of this material in the scientific literature<sup>[2]</sup>.

The objective of the 'PhotoKat' project was to close this knowledge gap and, by carrying out mechanistic studies of titanium dioxide-based and zinc oxide-based materials, to identify and optimise active and selective photocatalysts for reducing CO<sub>2</sub>. The research teams working on the project sought to identify robust readily available catalytic systems based on oxide semiconductor composites that exhibited high photon yields and that had the potential to be used in large-scale industrial applications.

## 1.11.2 Project description

In order to develop structure-activity relationships based on the oxides  $\text{TiO}_2$  and  $\text{ZnO}$ , it was necessary to determine which structural and electronic properties a catalyst needs to exhibit in terms of its three-dimensional structure and its surface so that products such as methanol or methane can be produced in high yield and with high selectivity. The results would then be used for the targeted development of active catalysts that would enable selective control of the reaction pathways to these products. The project examined model catalysts with isolated centres, clusters and thin films of transition metal oxides, composites and commercially available  $\text{ZnO}$  and  $\text{TiO}_2$ . The aim was to use a variety of spectroscopic methods (UV/Vis, in situ IR, Raman and photoluminescence spectroscopy), temperature-programmed methods (desorption, reduction, surface reactions), electron paramagnetic resonance (EPR) and supplementary methods of characterisation from the fields of electrochemistry and semiconductor physics to identify and understand in detail the reaction pathway and the active centre.

However, it became apparent in the early phases of the project that reliable measurement data on the photocatalytic reduction of  $\text{CO}_2$  would only be obtainable if the measurements were carried out under extremely pure conditions. As the conversions achieved in nearly all of the international studies published were below  $10 \mu\text{mol gcat}^{-1} \text{h}^{-1}$ , the presence of even very small amounts of hydrocarbon contaminants can cause large errors in the measurement results<sup>[1]</sup>. This is particularly critical because  $\text{CO}_2$  is the most stable carbon containing molecule in the reactor, which means that all other carbon compounds that happen to be present (sealing materials, solvents, etc.) would react more rapidly than  $\text{CO}_2$  to produce apparent hydrocarbon products.

For this reason, a gas-phase photoreactor was developed and built during the project that allowed measurements to be carried out under conditions of extremely high purity (Fig. 33). All of the components in the photoreactor are suitable for use in vacuum equipment and have dry (i.e. grease-free) seals. Furthermore, all samples were also subjected to a comprehensive photocatalytic cleaning procedure that ensured that any other hydrocarbons, such as those still present from the synthesis of the photocatalysts, were removed down to the detection limit of the gas chromatographic trace analyser ( $< 1 \text{ ppm}$ )<sup>[3]</sup>.

## 1.11.3 Results

By conducting the studies using comparable ultrapure reaction conditions it was possible to acquire reliable data on the relative activity of the different



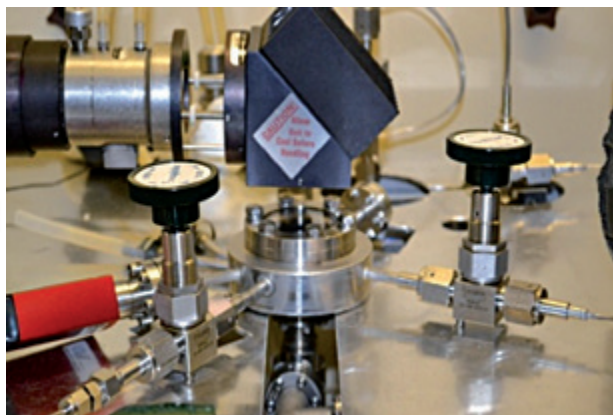
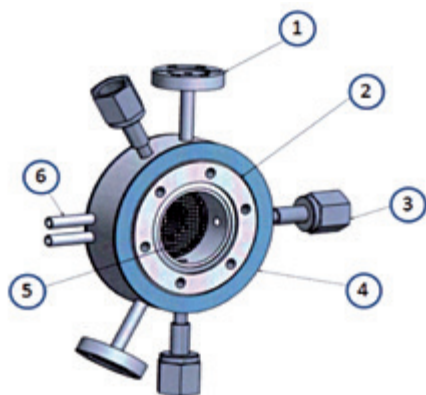

Fig. 33:

Left: Schematic representation of the ultrapure gas-phase photoreactor with CF flange connections (1), quartz window (2), VCR connections (3), cooling jacket (4), sample holder (5) and cooling water feed line (6); Right: Photo of the reactor with valves and deflecting mirror for the 200-W Hg(Xe) arc lamp

photocatalytic systems tested during the project. The activity data allowed the photocatalysts to be clearly distinguished from one another: Only the titanium dioxide-based materials exhibited any appreciable activity for the formation of methane from CO<sub>2</sub>. ZnO was far less active in this respect. Composites with gallium oxide, which were very active in photocatalytic water splitting, showed no activity for the formation of methane. Methanol was never detected as a product, even on titanium dioxide-based materials. However, other products were detected, including carbon monoxide, hydrogen, ethane and traces of propane.

The subsequent research work therefore focused on titanium dioxide systems. It was shown that under ultrapure reaction conditions, a number of commercially available titanium dioxides and isolated tetrahedral titanate species in SiO<sub>2</sub> functioned as active photocatalysts that were able to reduce CO<sub>2</sub> to methane<sup>[3]</sup>. In the first phase of the project, the isolated titanates were synthesised via a metalorganic anchoring mechanism ('grafting'). It was later demonstrated, however, that the commercially available zeolite TS-1, which contains tetrahedrally coordinated titanium centres, can also function as an active photocatalyst for the reaction (Fig. 34A). This demonstrates that it is immaterial whether the titanates are anchored to the surface of the silicon dioxide or securely embedded within the SiO<sub>2</sub> host lattice<sup>[4]</sup>. When gold nanoparticles were deposited onto TiO<sub>x</sub>/SBA-15, it was found that the methane yield almost doubled (Fig. 34B)<sup>[3]</sup>. However, under the conditions in which the gold nanoparticles were photodeposited, the previously isolated titanate centres became highly mobile and formed a TiO<sub>x</sub>-rich shell around the gold nanoparticles. It was demonstrated that this shell had a positive effect on the electron transfer process involved in the photocatalysis<sup>[5]</sup>.

Stable adsorption of  $\text{CO}_2$  was not detected on isolated titanates. It proved possible to increase the concentration of surface-adsorbed carbon dioxide by introducing isolated and agglomerated ZnO particles [6], though this had little effect on the activity of the catalysts with respect to methane formation. If isolated titanate species are used as photocatalysts, the adsorption of  $\text{CO}_2$  on the surface of the material is not necessary and may even impede the reaction.

The negative effect of strongly bound  $\text{CO}_2$ , in this case in the form of carbonates, was also demonstrated in studies of commercial titanium dioxide [7]. It was shown to be irrelevant whether carbonate formation was induced by surface modification or by sodium cations. Attempts to improve the methane yield through surface doping with other elements, such as divalent or tetravalent copper or tin, were also unsuccessful. The Cu-doped systems were, however, very active for hydrogen generation from aqueous methanol solutions [8]. Surface doping with Sn(II) accelerated the rate of selective hole transfer across the catalyst's phase boundary into the surrounding medium [9], while grafting Sn(IV) on the surface of the  $\text{TiO}_2$  increased the rate of electron transfer [10].

The latter stages of the project yielded significant insight into the reaction mechanism underlying the formation of methane on titanium dioxide [7]. An initial comparison of commercially available titanium dioxides showed that P25, which is a mixture of the two modifications anatase (80 %) and rutile (20 %), is the most active commercial material that also shows the lowest activity for the back reaction, i.e. decomposition of the hydrocarbon products. The main carbon-containing products generated with P25 were methane

Fig. 34:

A: Formation of methane and ethane on isolated titanate centres anchored on SBA-15 (T03) and commercial TS-1; B: Influence of photodeposited gold nanoparticles on the photocatalytic activity of titanate centres on SBA-15 in the formation of methane [3]; Reaction conditions: 1.5%  $\text{CO}_2$ , 0.6%  $\text{H}_2\text{O}$  in helium, irradiated with a 200-W HG(Xe) arc lamp.

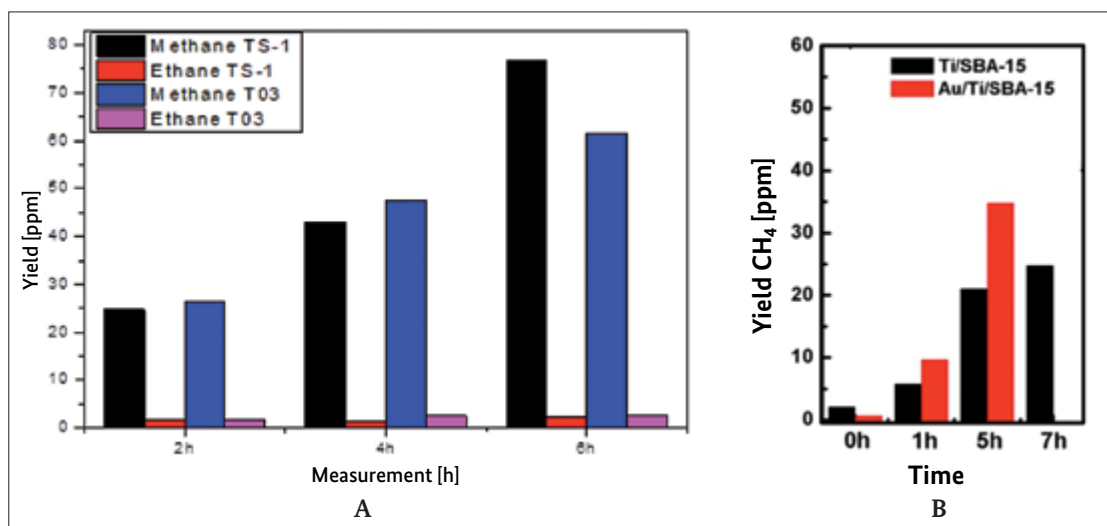

and carbon monoxide (Fig. 35A), with smaller quantities of hydrogen and ethane also being produced. It is also noteworthy that under the standard reaction conditions (1.5 % CO<sub>2</sub>, 0.6 % H<sub>2</sub>O in helium, room temperature and a total pressure of 1.5 bar), none of the self-made (non-commercial) photocatalysts exhibited activity greater than that observed with P25 for the production of carbon-containing products via the photocatalytic reduction of CO<sub>2</sub>. One commercial Au/TiO<sub>2</sub> catalyst (AUROLite™, STREM) did, however, exhibit higher activity for hydrogen generation, possibly via the preferential splitting of the water present in the gas phase.

Pure P25 was therefore selected for the subsequent detailed mechanistic studies. Typically, three mechanisms are discussed in the literature. One involves CO as a key intermediate, another proceeds via formaldehyde and methanol, and the third via species that contain a C–C bond<sup>[11,12]</sup>. Of these three mechanisms, the first two could be ruled out under the reaction conditions employed in the current study. Titanium dioxide shows no activity with respect to reaction with CO, so that even after 6 hours the initial concentration of CO was unchanged. Attempts to facilitate the formation of methane by depositing methanol, formaldehyde or formic acid onto the surface of the catalyst proved unsuccessful. None of these molecules show any appreciable electron affinity so that their oxidation or decomposition back to CO<sub>2</sub> or CO will always be preferred to the reduction reaction forming methane. A mechanism involving C<sub>2</sub> intermediates therefore appears much more probable than one involving the reduction of a C<sub>1</sub> molecule to form methane<sup>[7,12]</sup>. This is why the photocatalytic conversion of molecules such as acetic acid or acetaldehyde, which could in principle be formed by coupling CO<sub>2</sub> or CO with a methyl radical, leads to product distributions that are similar to those obtained from reducing CO<sub>2</sub> to methane under standard conditions.<sup>[7]</sup>

If, however, the mechanism requires a C–C bond to be formed, it would be of interest to test approaches that have already been used in research in the field of conventional thermal heterogeneous catalysis, such as Fischer-Tropsch catalysis, in order to facilitate C–C bond formation. This might increase the yields of ethane and other longer chain hydrocarbons. Another potential research topic that has arisen from the project results concerns accelerating the release of the co-product oxygen. Oxygen was never detected as a reaction product, presumably because it remains bound by adsorption to the photocatalyst material. However, peroxides or superoxides that remain in the catalyst material will ultimately lead to back reactions with the hydrocarbon products, thus reducing overall yields

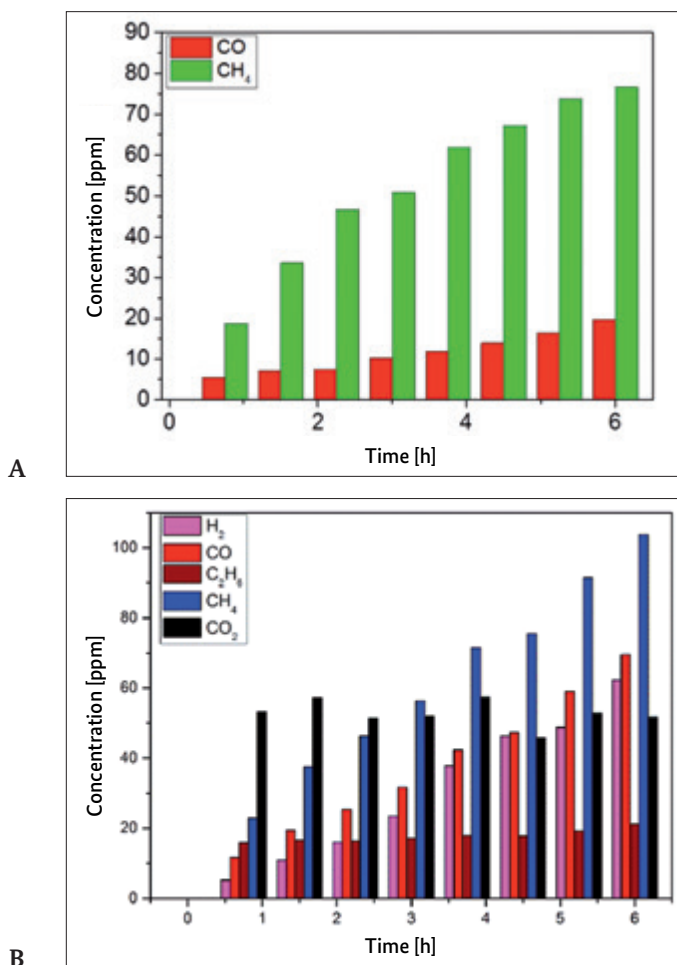

Fig. 35:

A: CH<sub>4</sub> and CO are the main products from the reduction of CO<sub>2</sub> on TiO<sub>2</sub> P25 (1.5% CO<sub>2</sub>, 0.6% H<sub>2</sub>O in He, 200 W Hg(Xe) arc lamp); B: Product distribution in the photocatalytic decomposition of acetaldehyde on P25 (200 W Hg(Xe) arc lamp).

#### 1.11.4 Exploitation, commercialisation and dissemination of results

The project was able to demonstrate that from a large number of candidate photocatalysts tested under ultrapure reaction conditions, commercial titanium dioxide and commercial TS-1 were the most active materials for the reduction of CO<sub>2</sub> to methane. Both materials are produced on an industrial scale and are relatively inexpensive to procure, making them suitable in principle for an industrial implementation of the CO<sub>2</sub> reduction process; the yields for methane and other valuable products are, however, still far too small. Neither surface doping to facilitate CO<sub>2</sub> adsorption, nor increasing the rate of transfer of charge carriers across the catalyst surface resulted in any significant increase in methane yields. Nevertheless, discovering that C<sub>2</sub> intermediates play a major role in the reaction to form methane represented a significant step forward. This and other advances made during the project

have improved our understanding of the underlying reaction mechanism and are helping to identify new or previously little explored areas that could boost the activity of photocatalytic materials, such as improving C–C bond formation on the catalyst or increasing the rate at which oxygen is released from the surface. In order to pursue these and other promising avenues of research in a follow-up project, a group proposal has been submitted for funding as part of the CO<sub>2</sub>Plus research and development programme ('PROPHECY: PROcess concepts for PHotocatalytic CO<sub>2</sub> reduction in conjunction with life-CYcle analysis').

### Acknowledgements

The authors would like to thank Prof. Dr. Martin Muhler for a very fruitful collaboration extending over many years. We are also very grateful to Dr. Ilya Sinev and Prof. Dr. Wolfgang Grünert for the structural characterisation of the photocatalysts using x-ray absorption spectroscopy.

### References:

- 1 E.V. Kondratenko, G. Mul, J. Baltrusaitis, G. O. Larrazábal, J. Pérez-Ramírez, *Energy Environ. Sci.* **6** (2013) 3112.
- 2 K. Maeda, T. Takata, M. Hara, N. Saito, Y. Inoue, H. Kobayashi, K. Domen, *J. Am. Chem. Soc.* **127** (2005) 8286.
- 3 B. Mei, A. Pougin, J. Strunk, *J. Catal.* **306** (2013) 184.
- 4 M. Dilla, A. Pougin, J. Strunk, to be submitted to *J. Energy Chem.* (2016).
- 5 B. Mei, C. Wiktor, S. Turner, A. Pougin, G. van Tendeloo, R.A. Fischer, M. Muhler, J. Strunk, *ACS Catal.* **3** (2013) 3041.
- 6 B. Mei, A. Becerikli, A. Pougin, D. Heeskens, I. Sinev, W. Grünert, M. Muhler, J. Strunk, *J. Phys. Chem. C* **116** (2012) 14318.
- 7 A. Pougin, M. Dilla, J. Strunk, *Phys. Chem. Chem. Phys.* **18** (2016) 10809.
- 8 A.E. Becerikli, A. Bähr, K.L. Chu, M. Muhler, J. Strunk, to be submitted to *Int. J. Hydrogen Energy* (2016).
- 9 F.E. Oropeza, B. Mei, I. Sinev, A.E. Becerikli, M. Muhler, J. Strunk, *Appl. Catal. B: Environmental* **140-141** (2013) 51.
- 10 S. Chu, A.E. Becerikli, B. Kortewille, F.E. Oropeza, J. Strunk, *Int. J. Hydrogen Energy* **39** (2014) 18784.
- 11 S. N. Habisreutinger, L. Schmidt-Mende, J. K. Stolarczyk, *Angew. Chem. Int. Ed.* **52** (2013) 7372.
- 12 I. A. Shkrob, T. W. Marin, H. He, P. Zapol, *J. Phys. Chem. C* **116** (2012) 9450.

# 1.12 OrgKoKat – New organocatalysts and cooperative catalytic processes for utilising CO<sub>2</sub> as a building block in chemical syntheses

BMBF Project FKZ 033RC1004

Project Coordinator: Dr. Thomas Werner, Leibniz-Institut für Katalyse e.V.

## 1.12.1 Introduction

The combustion of valuable fossil resources and the clearing of huge areas of forested land have led to a significant rise in emissions of the greenhouse gas CO<sub>2</sub> and to its accumulation in the atmosphere. The globally averaged concentration of CO<sub>2</sub> reached the 400 ppm mark for the first time in 2015. Global climate change is closely linked to the emissions of anthropogenic greenhouse gases, with emissions of carbon dioxide making up by far the largest part (78 %). The UN Climate Conference 2015 in Paris adopted the resolution to limit the global temperature rise in this century to well below 2 degrees above pre-industrial levels. This, however, will require a drastic reduction in CO<sub>2</sub> emissions. While preventing emissions of carbon dioxide generally has top priority, the use of CO<sub>2</sub> as a feedstock for the chemical industry is particularly interesting as CO<sub>2</sub> represents a cheap and essentially unlimited supply of carbon. Using CO<sub>2</sub> as a feedstock material will also expand the resource base of the chemical industry.

For these reasons, utilising CO<sub>2</sub> as a cost-effective C<sub>1</sub> building block has become the subject of increased academic and industrial research over the last few years. In view of the high inherent stability of CO<sub>2</sub>, converting it to more valuable products is a significant challenge. A key technology to solving this problem is catalysis. Significant progress has been made in this area thanks to the research and development programme ‘Technologies for Sustainability and Climate Protection – Chemical Processes and Use of CO<sub>2</sub>’ funded by the German Federal Ministry of Education and Research (BMBF).

If CO<sub>2</sub> is to be utilised chemically, it makes sense to adopt an approach in which it is converted to products in which carbon is in its highest oxidation state of +IV, as this would dispense with the need to introduce additional reducing agents (e.g. hydrogen). Two well known reactions, which were also studied in detail in the OrgKoKat project, are the addition of CO<sub>2</sub> to epoxides and the copolymerisation of CO<sub>2</sub> and epoxides to yield cyclic carbonates and

polycarbonates respectively <sup>[1]</sup>. Both products are of significant interest to the chemical industry because of their properties and the broad range of applications in which they can be used.

## 1.12.2 Project description

Part of the OrgKoKat project concentrated on developing new organocatalysts and cooperative catalyst systems that would facilitate the synthesis of cyclic carbonates and of polycarbonates (Fig. 36). Other project work was concerned with developing and conducting experimental studies of CO<sub>2</sub> activation routes that would enable more efficient utilisation of CO<sub>2</sub> as a synthetic building block. The integration of upstream and downstream process steps was also included in the study. The aim was to contribute to the development of direct and indirect options for utilising CO<sub>2</sub> and to open up promising new lines of enquiry in the field of CO<sub>2</sub> research.

Fig. 36:  
Subprojects within the OrgKoKat.  
Left: The synthesis of cyclic carbonates from epoxides or olefins;  
Right: The copolymerisation of CO<sub>2</sub> with epoxides to form polycarbonates.

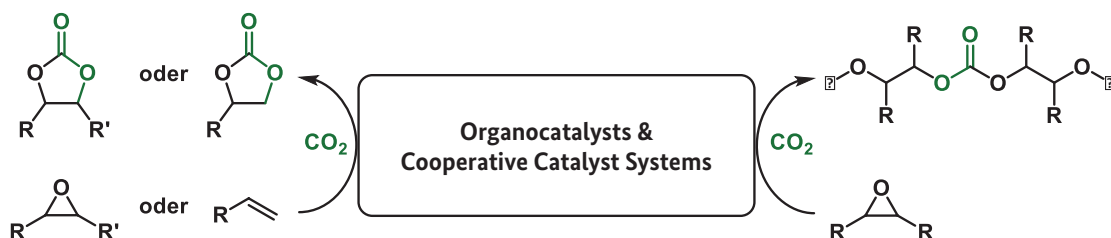
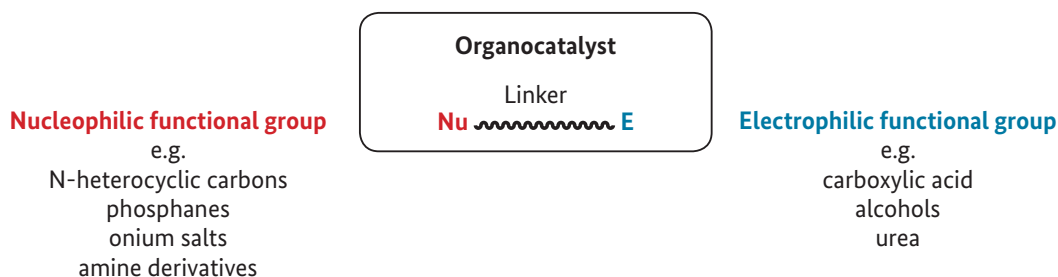

Fig. 37:  
Catalyst design concept for bifunctional organocatalysts.

The catalyst design concept shown in Fig. 37 provided the foundation for the experimental studies carried out during the project. The concept is based on bi- and multifunctional organocatalysts that can efficiently activate CO<sub>2</sub> or the relevant substrates. The plan was to synthesise and use bi- and multifunctional organocatalysts that contain both nucleophilic and electrophilic functional groups that are connected to each other via a linker.





### 1.12.3 Results

During the project, researchers at LIKAT developed a variety of organocatalysts and cooperative catalytic processes for synthesising cyclic carbonates from epoxides and  $\text{CO}_2$ . In addition to developing efficient organocatalytic systems that only activate the epoxide<sup>[2]</sup>, the research team also succeeded in developing processes in which both the epoxide and the  $\text{CO}_2$  were activated<sup>[3]</sup>. The individual systems were initially evaluated by studying the effects of the different reaction parameters (pressure, temperature, reaction time, etc.). This was followed by a substrate screening procedure, in which the reaction of various epoxides with  $\text{CO}_2$  was evaluated. One noteworthy result was that all of the systems that were developed were solvent-free. One of the systems developed was able to simultaneously activate the  $\text{CO}_2$  and the epoxide in close spatial proximity to one another (Fig. 38).

During the OrgKoKat project, a life cycle assessment (LCA) of the synthesis of glycerol carbonate methacrylate from the corresponding epoxide and  $\text{CO}_2$  was conducted in cooperation with Creavis Technologies & Innovation (Evonik) in Marl. The LCA showed that this synthetic route was also a good choice from the perspective of environmental impact. By utilising  $\text{CO}_2$  as a synthetic building block, the overall  $\text{CO}_2$  emissions burden (expressed in terms of  $\text{CO}_2$  equivalents) can be reduced by up to 3 %. Two cooperative

Fig. 38:  
Cooperative catalyst system for the simultaneous activation of  $\text{CO}_2$  and epoxides (left) and the experimental set-up for the catalyst screening campaign (right).

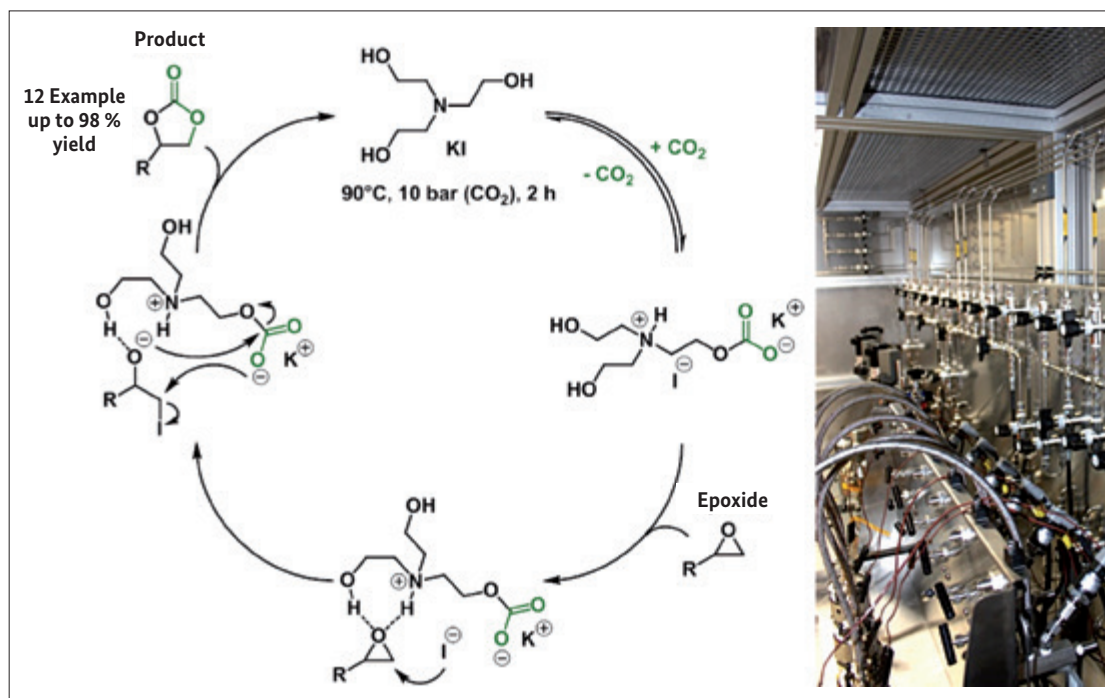

catalyst systems were developed for the reaction of bio-sourced epoxides with CO<sub>2</sub>, based on the idea of combining an additive (MoO<sub>3</sub> or FeCl<sub>3</sub>) with a phosphonium salt as the catalyst [4]. The resulting fatty acid carbonates and carbonated oils are based essentially completely (> 99 %) on renewable raw materials. It also proved possible to develop a bifunctional organocatalyst that enabled the reaction to be carried out efficiently at a temperature as low as 80 °C.

Catalyst recycling was another important issue that was extensively studied in the OrgKoKat project. A number of different recycling strategies (distillation, organic solvent nanofiltration and catalyst immobilisation) were studied comprehensively [5]. Immobilisation of bifunctional organocatalysts on inorganic and organic carrier materials proved to be a particularly efficient recycling method (Figure 5). It was shown that the catalyst could be reused up to ten times without any loss of activity. A broad substrate screening programme was also carried out to evaluate potential areas of application of the supported catalysts.

Fig. 39:  
Results for the use of different additives in the [Bu<sub>4</sub>P]Br-catalysed reaction of methyl oleate to form the cyclic carbonate.

The work on polycarbonate synthesis required the synthesis of a large number of urea derivatives. These were used to stabilise the anionic intermediates that form during the copolymerisation of CO<sub>2</sub> and epoxides. Attempts were

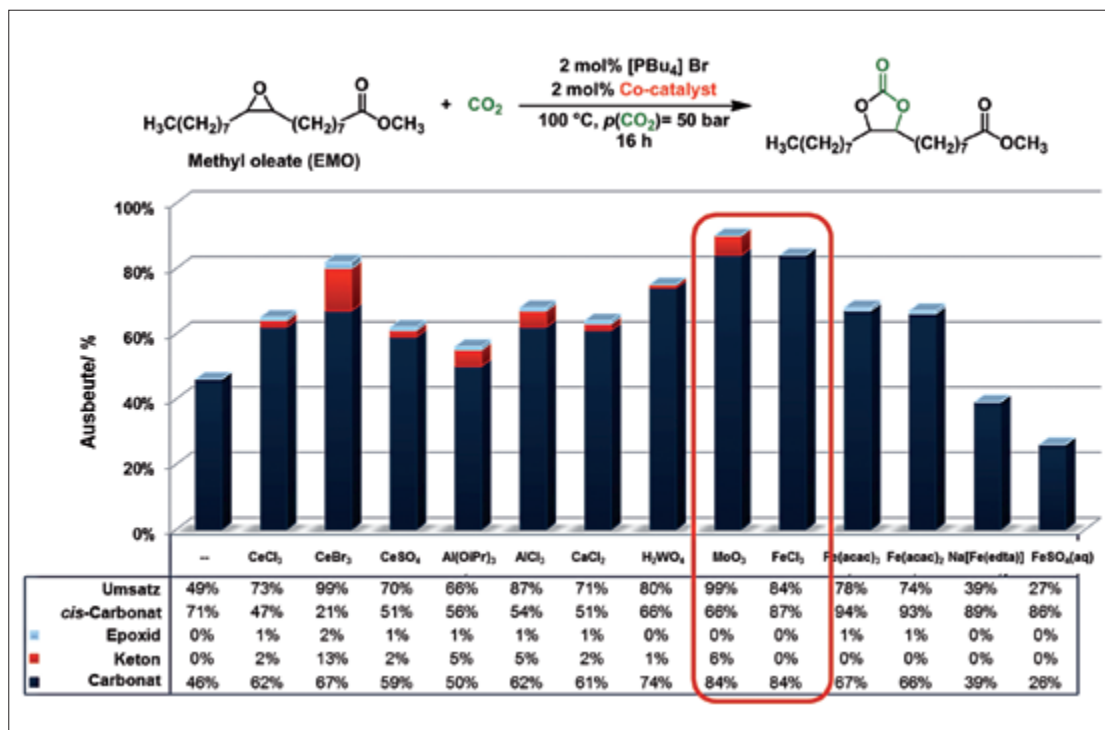

made to combine these compounds with organic co-catalysts in order to develop a pure organocatalytic system for the copolymerisation of epoxides with CO<sub>2</sub>. While these attempts were unsuccessful, the addition of metal salts and metalorganics lead to the development of numerous cooperative catalyst systems. Furthermore, a sequential process for synthesising isocyanate-free polyurethanes from biscarbonates and amines was established. The basis for these reactions were the bifunctional organocatalysts that we developed. We were able to demonstrate in follow-up studies that this can also be achieved from the bis(epoxide) in a one-pot process.

### 1.12.4 Exploitation, commercialisation and dissemination of results

As a result of the project 'New organocatalysts and cooperative catalytic processes for utilising CO<sub>2</sub> as a building block in chemical syntheses' significant steps were taken towards the goal of achieving resource-friendly and energy-efficient syntheses of industrially relevant products. The research work carried out during the project made important progress, particularly regarding the synthesis of cyclic carbonates and polycarbonates. The results achieved have highlighted a number of potentially promising industrial

Fig. 40: Reaction conditions (top) for using silica- and polystyrene-supported bifunctional organocatalysts and selected products (middle). Recycling experiment for the conversion of butylene oxide (bottom).

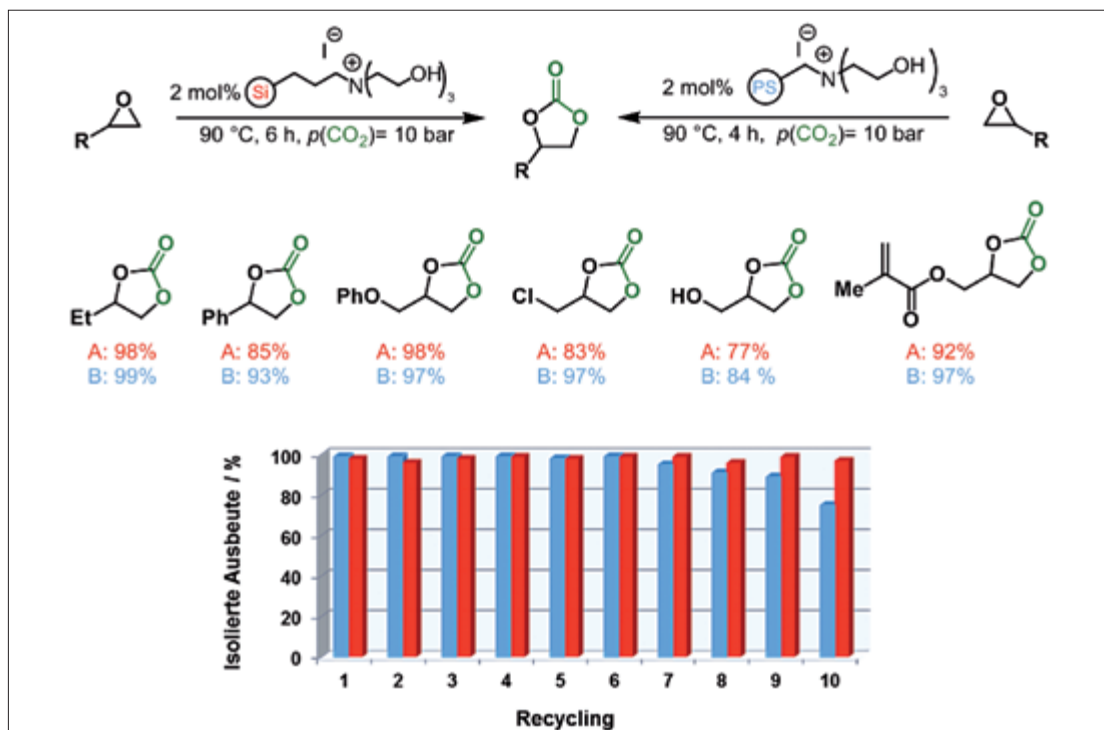

applications. For example, carbonated fatty acid derivatives and carbonated oils and fats have the potential to be marketed as bio-sourced plasticisers. Using CO<sub>2</sub> as a chemical building block, both directly and indirectly in the form of fatty acid derivatives, is an important concept on the path to establishing a new non-fossil-based raw materials base. Similarly, the use of glycerol carbonate methacrylate as a (co-)monomer is also of significant interest. As work-up procedures tend to be complex in the case of product mixtures, the production process employed needs to be correspondingly efficient. One potentially valuable approach involves the use of the immobilised organocatalysts developed during the project in a continuous process. Currently a number of different follow-up projects are underway that are building on findings from the OrgKoKat project. For example, further studies are being conducted into the isocyanate-free synthesis of polyurethanes as well as into the use of immobilised bifunctional organocatalysts.

### Acknowledgements

The authors would like to thank Prof. Dr. Matthias Beller and the Leibniz Institute for Catalysis at the University of Rostock for continuing and generous support. We would also like to thank Dr. Matthias Blugg (Evonik), Dr. Alexandra Grosse Böwing (Covestro), Dr. Daniela Kruse (Evonik), Dr. Aurel Wolf (Covestro) and Dr. Benjamin Schäffner (Evonik) for the close and very effective collaboration and support over the course of the project.

### References:

- [1] a) M. Peters, B. Köhler, W. Kuckshinrichs, W. Leitner, P. Markewitz, T. E. Müller, *ChemSusChem* **2011**, *4*, 1216–1240; b) Y. Qin, X. Sheng, S. Liu, G. Ren, X. Wang, F. Wang, *J. CO<sub>2</sub> Util.* **2015**, *11*, 3–9; c) J. W. Comerford, I. D. V. Ingram, M. North, X. Wu, *Green Chem.* **2015**, *17*, 1966–1987; d) C. Martin, G. Fiorani, A. W. Kleij, *ACS Catal.* **2015**, *5*, 1353–1370; e) M. Cokoja, M. E. Wilhelm, M. H. Anthofer, W. A. Herrmann, F. E. Kühn, *ChemSusChem* **2015**, *8*, 2436–2454.
- [2] a) T. Werner, H. Büttner, *ChemSusChem* **2014**, *7*, 3268–3271; b) T. Werner, N. Tenhumberg, H. Büttner, *ChemCatChem* **2014**, *6*, 3493–3500; c) H. Büttner, J. Steinbauer, T. Werner, *ChemSusChem* **2015**, *8*, 2655–2669; d) H. Büttner, K. Lau, A. Spannenberg, T. Werner, *ChemCatChem* **2015**, *7*, 459–467; e) W. Desens, C. Kohrt, A. Spannenberg, T. Werner, *Org. Chem. Front.* **2016**, *3*, 156–164.
- [3] a) T. Werner, N. Tenhumberg, *J. CO<sub>2</sub> Util.* **2014**, *7*, 39–45; b) W. Desens, T. Werner, *Adv. Synth. Catal.* **2016**, *358*, 622–630.
- [4] a) N. Tenhumberg, H. Büttner, B. Schaffner, D. Kruse, M. Blumenstein, T. Werner, *Green Chem.* **2016**, *18*, 3775–3788; b) H. Büttner, C. Grimmer, J. Steinbauer, T. Werner, *ACS Sustainable Chem. Eng.* **2016**, DOI: 10.1021/acssuschemeng.6b01092.
- [5] a) J. Großeheilmann, H. Büttner, C. Kohrt, U. Kragl, T. Werner, *ACS Sustainable Chem. Eng.* **2015**, *3*, 2817–2822; b) W. Desens, C. Kohrt, M. Frank, T. Werner, *ChemSusChem* **2015**, *8*, 3815–3822; c) C. Kohrt, T. Werner, *ChemSusChem* **2015**, *8*, 2031–2034.

# 1.13 ACER – Natriumacrylat from CO<sub>2</sub> and Ethene

BMBF Project FKZ 033RC1015

Project Coordinator: Dr. Thomas Schaub, BASF

Project Partner: hte, Universität Stuttgart, Technische Universität München

## 1.13.1 Introduction

The aim of the project was to find process conditions and catalysts for a new synthesis of sodium acrylate (Na-acrylate) from carbon dioxide (CO<sub>2</sub>) and ethene.

Currently acrylic acid is produced from propene by a two-stage oxidation process. The sodium acrylate is then obtained by reacting the acrylic acid with NaOH (see diagram 1), which currently produces about 4 million tonnes per year in this way worldwide, the main application of which is the production of superabsorbent.

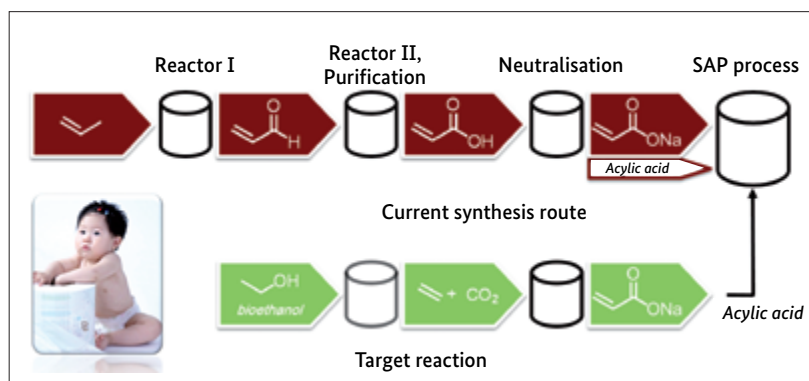

Fig. 41: Current synthesis route and target response

Effective homogeneous or heterogeneous catalysts should be found for the target reaction not known at the beginning of the project. The individual steps of a possible catalysis cycle have been investigated for more than 30 years, but it has not been possible to conclude it in terms of productive catalysis. Hoberg et al. discussed nickel alactones („Hoberg complexes“)<sup>[1]</sup> as stable and isolatable intermediates of a catalytic coupling of ethene and CO<sub>2</sub>. Critical steps are the β-hydride elimination and the reductive elimination of acrylic acid or sodium acrylate. Although the reaction of ethylene with CO<sub>2</sub> in the presence of NaOH is exergonic ( $\Delta G = -56.2$  kJ/mol), a suitable combination of catalyst metal, ligand and base (CO<sub>2</sub> tolerance) could not be identified in the previous work.<sup>[2]</sup>

### 1.13.2 Project description

The planned project showed a high degree of scientific and technical complexity, which is why the work was carried out in a three-year joint project with the project partners BASF SE, hte AG, Catalysis Research Laboratory (CaRLa), University of Stuttgart (AK Klemm) and TU Munich (AK Rieger).

The task of the CaRLa, which is operated by BASF SE and the University of Heidelberg, as well as the Rieger Group at the Technical University of Munich, was to carry out basic research into the development of catalytic reaction control, starting with investigations into the understanding of the mechanism, through spectroscopic characterisation under reaction conditions, to the preparative synthesis of model catalysts for homogeneous reaction control.

The testing of a large number of promising homogeneous and heterogeneous catalysts was the task of hte. While the preparation of the heterogeneous catalyst candidates was carried out exclusively by hte, the homogeneous catalyst candidates were also provided and tested by the project partners TU Munich and BASF/CaRLa.

In the group “Klemm” at the University of Stuttgart, work was carried out on modelling the phase behaviour, the individual process stages and the overall process. This supported the process design. Furthermore, the individual process steps such as reaction, reprocessing and purification were investigated experimentally using model systems.

In the CaRLa Catalyst Laboratory, BASF has examined its own and the model catalysts provided by the Technical University of Munich for their suitability from an industrial point of view and has tested various reaction control variants, found independent catalyst systems and studied their mode of action. Furthermore, the individual process steps such as reaction, reprocessing and purification were investigated experimentally using model systems.

All project partners have regularly exchanged ideas and opinions on a large team or bilaterally. hte has made resources available to all project partners, especially BASF/CaRLa, for catalyst testing and evaluation. The TUM has investigated kinetics with CaRLa ligand systems. Furthermore, samples of CaRLa and hte were regularly examined at the University of Stuttgart. BASF/CaRLa and TUM have provided analytical resources to all project partners (NMR, in situ IR, HPLC). In addition, BASF/CaRLa supported the work packages of all project partners, especially hte’s work packages with quantum mechanical calculations.

The basis and starting point for the mechanistic and experimental work was the hypothetical catalysis cycle with nickel alactones as intermediates (see Fig 42). On the basis of this, systems were investigated with which the oxidative coupling of ethylene and  $\text{CO}_2$  (A), the base-induced lactone cleavage (B) and the final ligand exchange (D) can be carried out.<sup>[2]</sup> The focus was on nickel-phosphane complexes, with the help of which suitable reaction conditions and bases should be identified in order to enable catalytic reaction control. Since NaOH reacts irreversibly with  $\text{CO}_2$  to form carbonates, which are not basic enough to initiate lactone cleavage, the choice of base was decisive in addition to the design of a suitable catalyst. The base should not react irreversibly with  $\text{CO}_2$ , enable lactone cleavage and can also be regenerated with NaOH. The extensive quantum mechanical calculations made it possible to rationalise the experimental procedure and specifically improve the system.<sup>[3b,4]</sup>

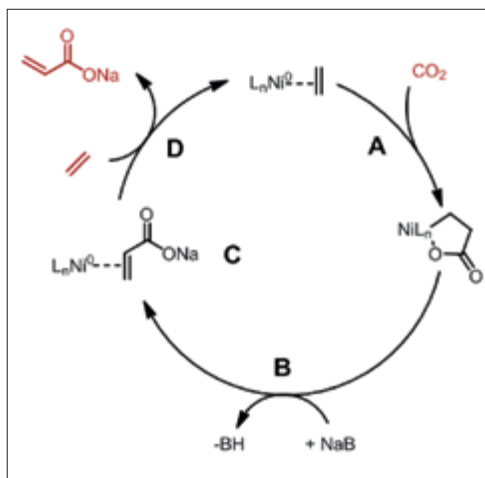

Fig. 42:  
Catalysis cycle of the nickel-  
catalysed NaAcrylate synthesis

Since no heterogeneous catalysts were known for this target reaction at the start of the project, more than 460 catalysts were investigated in nine different libraries using high-throughput experiments. In addition to the search for pure heterogeneous catalysts, hte also evaluated the extent to which defined nickel complexes or base can be heterogenized in order to simplify product separation or catalyst recycling.

### 1.13.3 Results

First of all, a one-pot system was developed in which sodium acrylate could be produced catalytically with respect to the nickel used by repeating different reaction cycles (low  $\text{CO}_2$  atmosphere with addition of base; NaOMe as base). However, the highest turnovers here were only 10.

Based on this system and the experiences with it, the first true style catalysis was achieved using Ni (COD) 2 in combination with a chelate phosphane ligand and fluorophenolate bases.<sup>[6,7]</sup>



Fig. 43:  
Nickel-catalysed sodium  
acrylate synthesis using  
phenolate bases

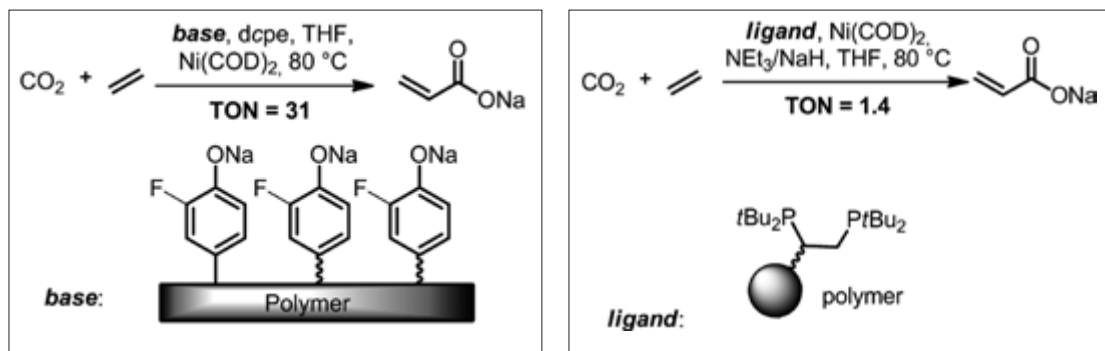
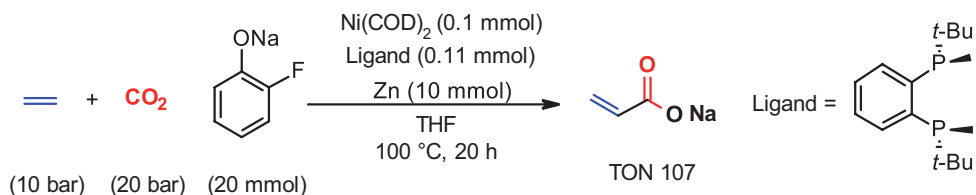

Fig. 44:  
Immobilisation in nickel  
catalysed sodium  
acrylate synthesis

While no active heterogeneous catalysts for the reaction could be identified in the project, the approach of immobilisation of the base of the homogeneous system proved to be successful (Fig. 44). The fluorophenolate base was immobilised on a polymer framework and TON of 31 was obtained, which can facilitate a simple recirculation of the base in a potential process.<sup>[8]</sup>

### 1.13.4 Exploitation

After the end of the funding period, BASF is pressing ahead with process development in order to generate the basic data for an investment and production cost estimate in a continuous laboratory plant. In a new project (financed by BASF) the catalyst system is being optimized in cooperation with CaRLa so that it can be used for continuous reaction control (Fig. 45). Bases that are easier to separate and recycle from the product and more active and stable homogeneous catalysts have been developed, which is a further step towards the application of this reaction.<sup>[9]</sup>

Fig. 45:  
Process concept for the  
continuous production of  
sodium acrylate

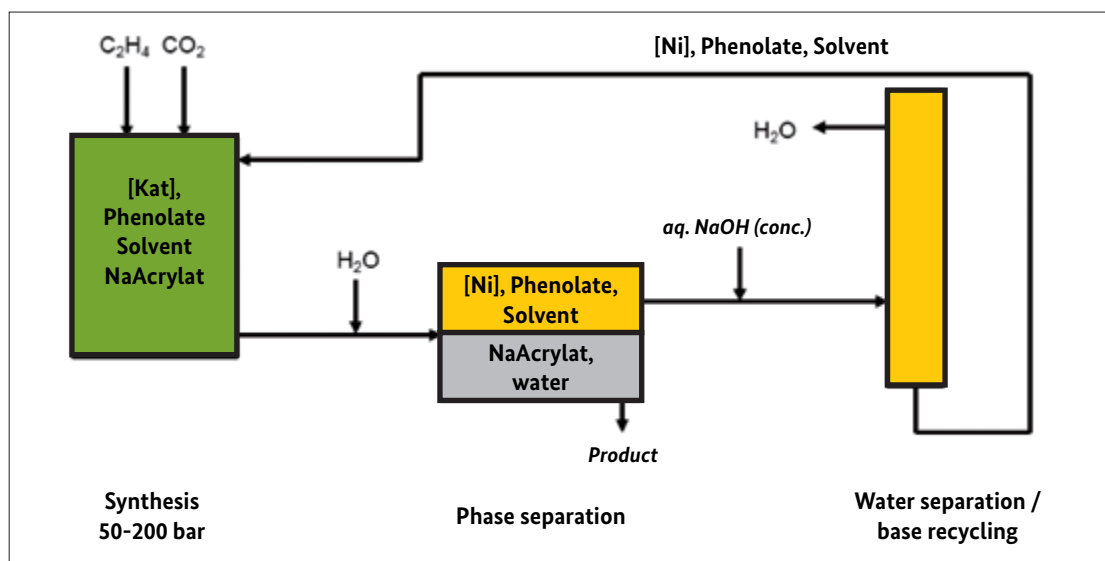

**References:**

- [1] a) Hoberg H., Peres Y., Krüger C., Tsay Y.H., *Angew. Chem.* 1987; 99: 799–800; *Angew. Chem. Int. Ed. Engl.* 1987; 26: 771–773; b) Hoberg H., Sümmermann K., Milchereit A. *Angew. Chem.* 1985; 97: 321; *Angew. Chem. Int. Ed. Engl.* 1985; 24: 325–326.
- [2] Limbach, M., *Adv. Organomet. Chem.* 2015, 63, 175-202.
- [3] a) Jin D., Williard P.G., Hazari N. Bernskoetter W.H., *Chem. Eur. J.* 2014, 20, 3205–3211; b) Plessow P.N, Weigel L., Lindner R., Schäfer A., Rominger F. Limbach M., Hofmann P., *Organometallics* 2013, 32, 3327–3338; c) Hoberg H., Ballesteros A., Sigan A., Jegat C., Milchereit A., *Synthesis* 1991, 395–398.
- [4] Plessow P.N., Schäfer A., Limbach M., Hofmann P., *Organometallics* 2014, 33, 3657 – 3668.
- [5] a) Lejkowski M. L., Lindner R., Kageyama T., Bódizs G.E, Plessow P.N., Müller I.B., Schäfer A., Rominger F., Hofmann P., Futter C., Schunk S.A., Limbach M., *Chem. Eur. J.* 2012, 18, 14017 – 14025; b) Limbach M., Lindner R., Lejkowski M.L., Kageyama T., Bodizs G.E., Schunk S.A., Futter C., Rother J., WO 2013098772
- [6] Huguet N., Jevtovikj I., Gordillo A., Lejkowski M., Lindner R., Bru M., Khalimon A.Y., Rominger F., Schunk S.A., Hofmann P., Limbach M, *Chem. Eur. J.* 2014, 20, 16858 – 16862.
- [7] a) Limbach M., Lejkowski M., Huguet Subiela N., Gordillo A., Lindner R., Bru-Roig M., Schunk S.A., WO 2015173277; b) Limbach M., Jevtovikj I., Huguet-Subiela N., Gordillo A., Stieber S.C.E., Lindner R., Bru Roig M., Lejkowski M., Kageyama T., Schunk S.A., WO 2015173276.
- [8] a) Limbach M., Futter C., Schunk S.A., Lejkowski M., Gordillo A., Prasetyo E., WO 2015173296; b) Limbach M., Futter C., Schunk S. A., Lejkowski M., Gordillo A., Prasetyo E., WO 2015173295.
- [9] Manzini S., Huguet N., Trapp O., Schaub T., *Eur. J. Org. Chem.*, 2015, 32, 7122-7130.

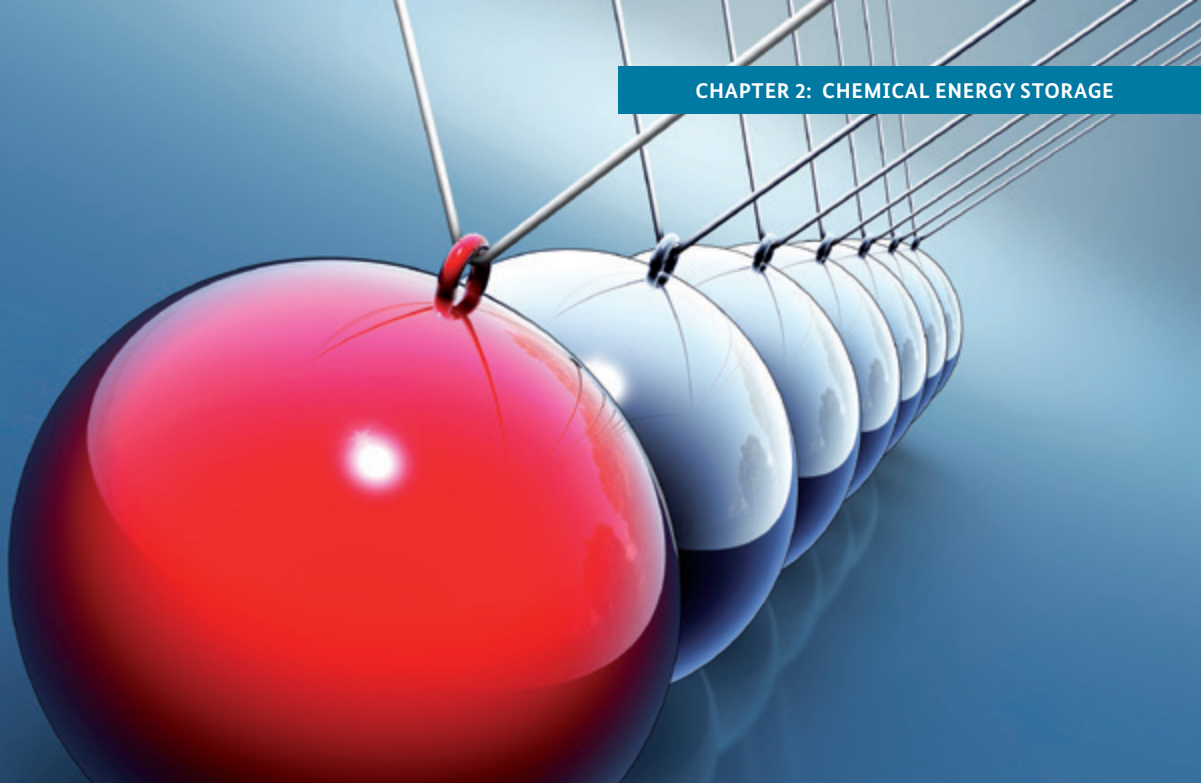

## 2.1 Chemical Energy Storage

*Prof. Dr. Michael Sterner, M. Sc. Fabian Eckert, M. Sc. Martin Thema  
Energy Networks and Energy Storage Research Group (FENES), OTH Regensburg*

### 2.1.1 The significance of PtX sector coupling in the transition to renewable energy

#### 2.1.1.1 **Chemical energy storage technology as the backbone of the energy supply system**

Humans have always made use of energy storage systems. Photosynthesis has served as a means of storing the energy of solar radiation. In photosynthesis, light energy splits water and the reaction of hydrogen and carbon dioxide ( $\text{CO}_2$ ) generates biomass, which over millions of years is transformed into fossil fuels. The energy in these fuels is stored in the form of chemical bonds, which is why these fuels can be regarded as chemical energy stores. The energy storage efficiency of photosynthesis is, however, very low (0.5–2.5%). For many thousands of years, the supply of energy was 100% renewable – being predominantly based on wood as an energy store and energy source.

Since the Industrial Revolution, man has been exploiting the reserves of ancient ‘stored solar energy’ in the form of fossil fuels such as crude oil, natural gas and coal. The quantities of fossil fuels being used has risen exponentially for many decades and this has resulted in a huge increase in the amounts of fossil-based CO<sub>2</sub> released into the atmosphere, which is the main driver of anthropogenic climate change. Today, fossil fuels are still the dominant global primary energy source.

However, as fossil fuel reserves and resources become more and more depleted, there is a need to replace them with renewable energy sources and energy storage systems. Chemical energy storage systems will continue to play a key role, though the chemical substances that store the energy will now be ‘freshly’ produced using renewable sources of energy. Global investments in wind and solar power now exceed those in conventional power plants. The next major step in the switch to a fully renewables-based energy sector is therefore to find ways of storing and converting these fluctuating renewable energy sources.

The long-term vision is to make sustainable use of the storage process in biomass, to create technical systems that reproduce this type of energy storage and to research and develop new forms of energy storage technology.

### **2.1.1.2 Sector coupling as part of the energy transition**

The leaders’ declaration from the G7 summit in Elmau and the Paris Climate Accord have produced agreement that the use of fossil fuels and fossil-based raw materials is to be phased out. Germany has set itself some ambitious climate action goals, which includes achieving complete decarbonisation by 2050. This will require increased energy efficiency in all sectors of the economy and greater use of renewable sources of energy, which primarily means the construction and installation of more wind and solar power facilities. This will transform renewable electricity into a primary energy source, but one whose supply – in contrast to fossil-based primary energy resources – will be subject to fluctuations.

While action has been taken over the last few decades in the field of power generation, i.e. in accessing, developing and converting renewable sources of energy, too little technological progress has been made in the areas of power networks, energy storage and integration.

Comprehensive answers have already been found to many of these questions in the electricity, heating and transport sectors. Technical solutions such as the use of power-to-gas products for long-term energy storage are already available<sup>[1,2]</sup>. In the electricity sector, numerous studies have been published that demonstrate the technical feasibility of a complete transformation of

the electric power sector [3,4]. Studies of the decarbonisation of the heating and transport sectors have identified the need for stronger inter-sector coupling and networking [5, 6]. The remaining unresolved energy policy questions thus concern issues such as implementing grid expansion, efficiency improvements and the introduction of different energy storage and conversion processes to make the technology economically feasible.

### 2.1.1.3 Decarbonisation of the raw materials sector

Questions regarding the decarbonisation of non-energy-related uses of fossil-based resources are primarily an issue faced by the chemical industry and remain largely unanswered. As the current dialogue on achieving climate

Fig. 46:  
Energy diagram for primary, secondary and useful energy for Germany in the years 2015 and 2050 including all of the necessary sector-coupling pathways [7].

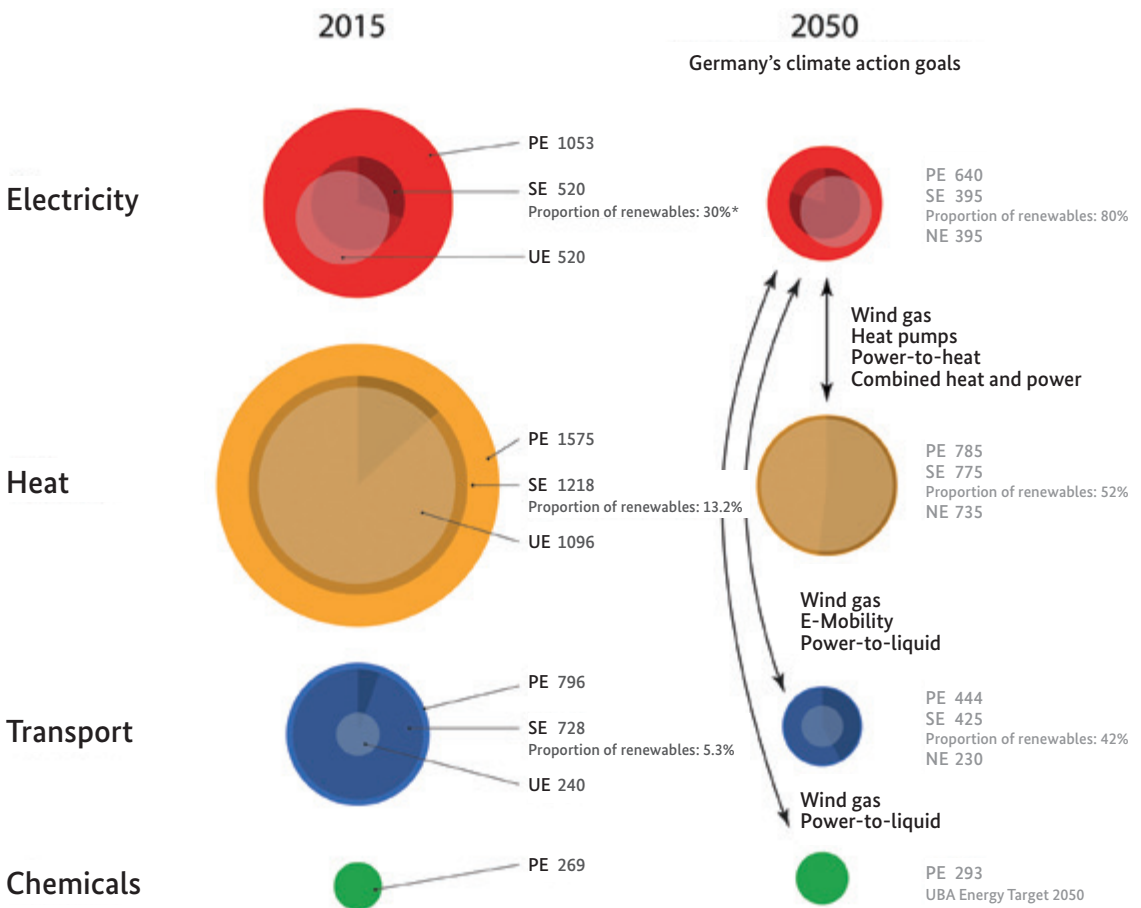

The size of the circular areas is proportional to the amount of energy  
 PE: Primary energy in TWh using an assumed conversion efficiency of 100% for wind, solar and hydro, but percentage view is distorted  
 SE: Secondary energy in TWh. Note: does not take the exergy values (available energy) of the different energy forms (electricity, combustion fuels, transport fuels) into account.  
 UE: Useful energy in TWh deployed for energy services electricity, heating and mobility (mechanical energy)  
 \* provisional data  
 Based on data from: BMBF-Energiedaten (2016), Statista (2016), Energieeinsparverordnung (EnEV 2014, UBA-Energieziel2015 (2014)

action goals includes discussion of largely unexplored technologies for atmospheric carbon capture ('negative emissions'), it seems appropriate to take a closer look at decarbonisation in those areas that utilise fossil-based raw materials. This does not, however, mean a complete rejection of CO<sub>2</sub>, but rather its intelligent use as a raw material ('carbon capture and use - CCU').

Power-to-X energy storage and energy conversion technologies will therefore play a crucial role in this phase of the decarbonisation process and in the transition to a renewables-based energy sector and renewables-based raw materials.

## 2.1.2 Storage technologies and storage pathways

### 2.1.2.1 Defining energy storage systems

Energy storage systems can be classified in a number of different ways based on physical characteristics, power ratings, discharge times, size or economic criteria. One of the most common classification schemes is based on physical criteria and categorises storage systems into electrical, electrochemical, chemical, mechanical and thermal energy storage systems. Figure 47 shows the most important representatives for each type of storage system.

Energy storage systems can also be classified in terms of whether they are sector-specific or have cross-sector functionality. This classification scheme is acquiring increasing significance in current discussions about the energy transition. As described in Section 2.1.1.2, sector coupling is important as electricity from renewable energy sources (RES-E) will become the primary energy form in all sectors and will thus play an essential part in any decarbonisation strategy. Figure 48 provides a schematic representation of this scenario. Power-to-X technologies essentially extend the use of RES-E

Fig. 47:  
Energy-based classification  
of energy storage systems [7]

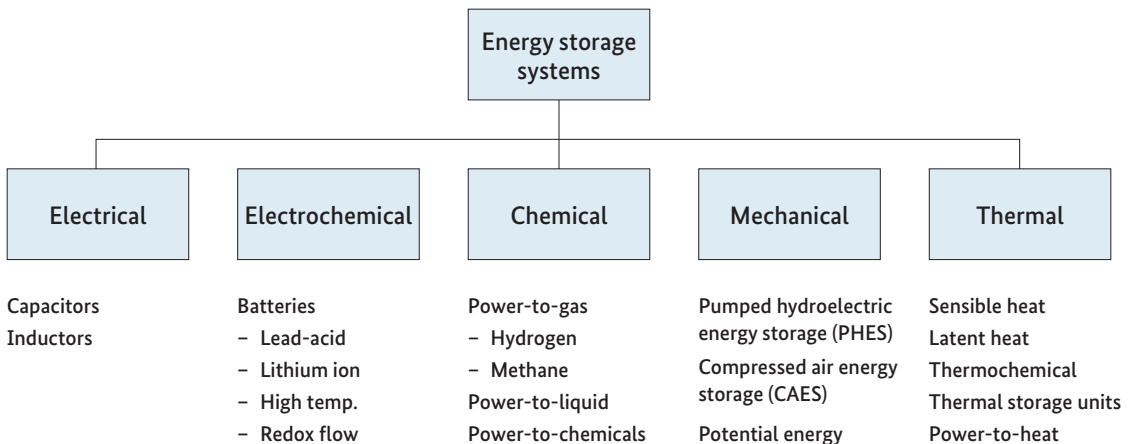



beyond its current role in the electricity generating and distribution sector by converting it into fuels and chemical feedstock materials. The electrification of the transport sector and coupling of the electric power and heat sectors through power-to-heat solutions are further RES-E utilisation pathways to decarbonising the energy system.

In contrast, sector-specific energy storage systems are the conventional energy storage facilities, such as pumped hydroelectric energy storage, thermal energy storage, or the fuel tanks in vehicles or filling stations used in the transport sector.

### 2.1.2.2 Definition of power-to-gas and power-to-X technologies

Power-to-gas (PtG) or power-to-X (PtX) technology acts as a bridge between the different sectors of the energy system. According to [7], PtX is defined as follows:

‘Power-to-X describes the conversion of electricity as a primary energy form and resource into an energy carrying medium, such as heat, cold, products, fuels or chemical feedstocks. It is a collective term that covers power-to-gas, power-to-liquid, power-to-fuel, power-to-chemicals, power-to-product and power-to-heat.’

The resulting hierarchy of technology pathways is shown in Figure 49.

Fig. 48: Definition of sector-specific and cross-sector energy storage systems (sector coupling) [7]

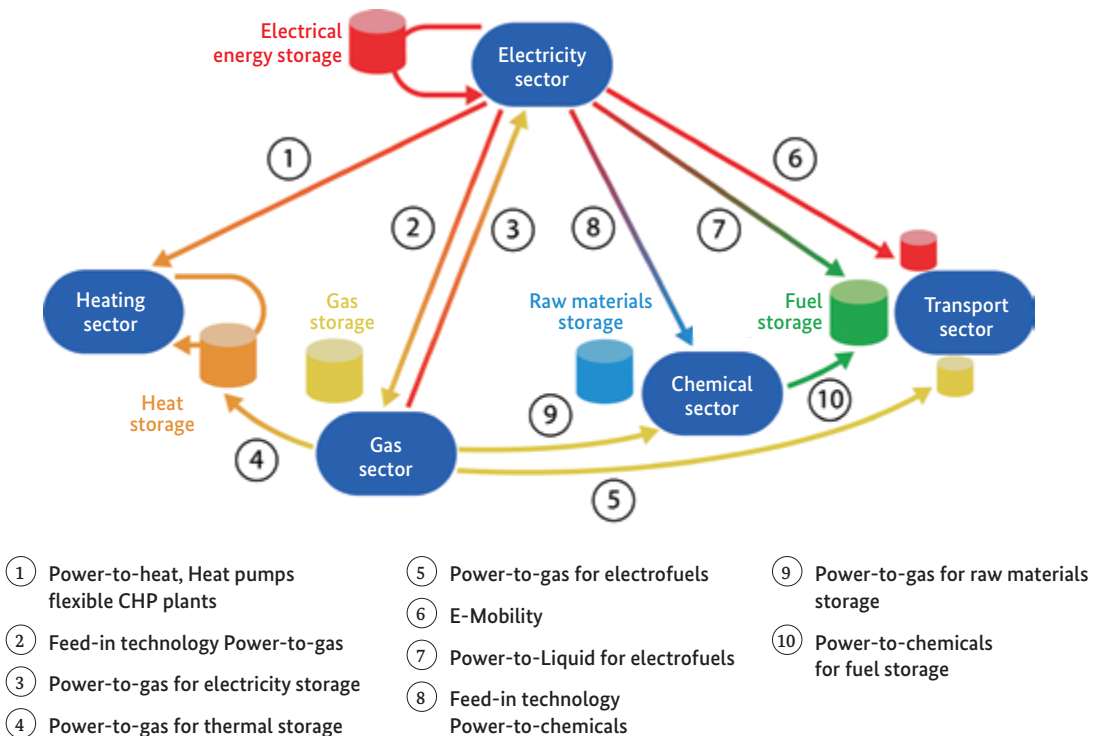

### 2.1.2.3 Comparison of energy storage technologies

In addition to referring to classification schemes, making technical and economic comparisons of the available technologies is a key element in determining which energy storage technology is best suited for a particular purpose.

Initially, the energy storage systems are compared in terms of investment cost per unit of energy storage (€/kWh) and investment cost per unit of power output (€/kW). This comparison enables the technologies to be categorised as either short-term, medium-term or long-term storage systems. If the price per kilowatt is comparatively low and the price per unit of stored energy relatively high, then from an economic perspective the system is suitable for use as a short-term or medium-term energy storage solution. If the situation is reversed (price per kW is high, price per kWh is low), then the technology is better suited for energy storage over a period of weeks or months. The relationship between price per kW and price per kWh is shown in Figure 1.5 for the most important electricity storage systems. The technologies can be clearly distinguished in terms of their discharge times batteries are

Fig. 49: Overview of PtX technology pathways. (Source: compiled by the authors)

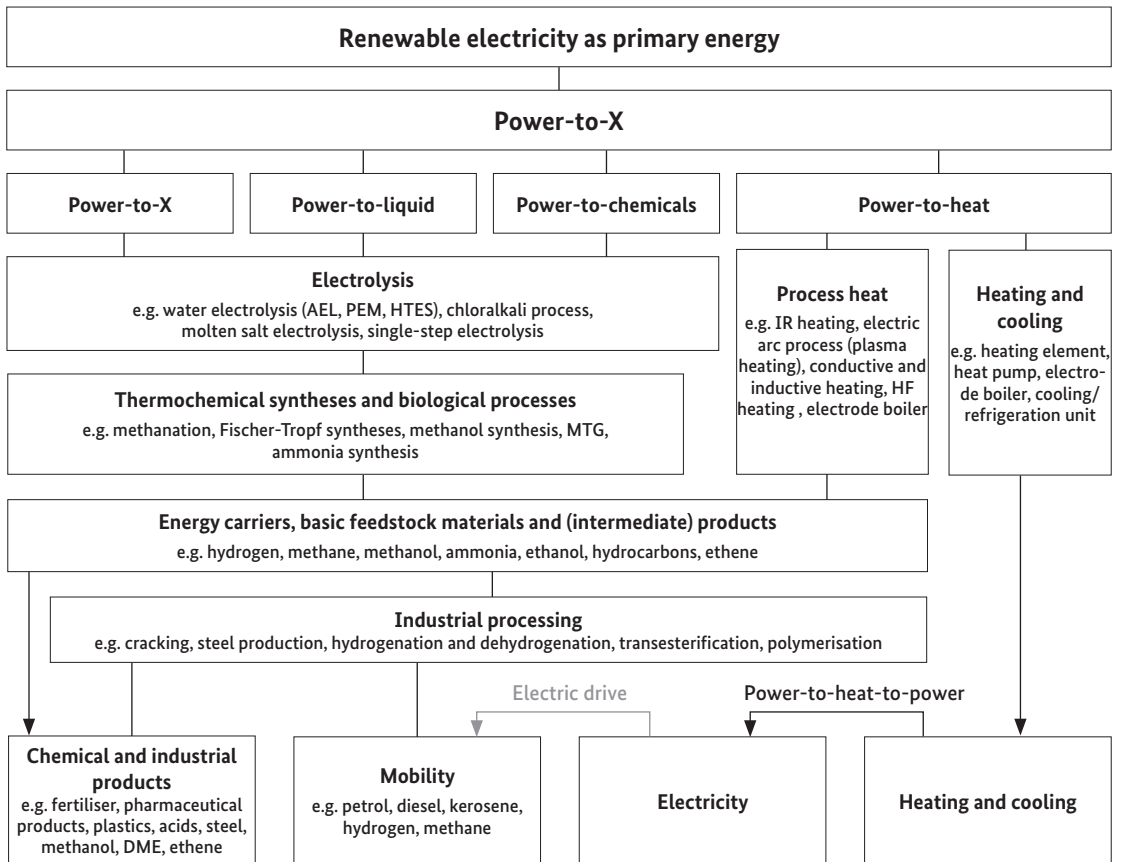

generally used for the short-term storage of electrical energy, compressed air energy storage and pumped hydroelectric energy storage tend to be used for balancing daily or weekly fluctuations, while from a purely economic perspective power-to-gas technology is best used for the long-term storage of electrical energy.

When combined with power-to-heat technology, thermal energy storage systems are very competitively priced both in terms of price per kilowatt and price per kilowatt hour and are therefore suitable for both short-term and long-term storage timeframes. However, an important caveat applies in this case, as large amounts of energy are required in order to reconvert the

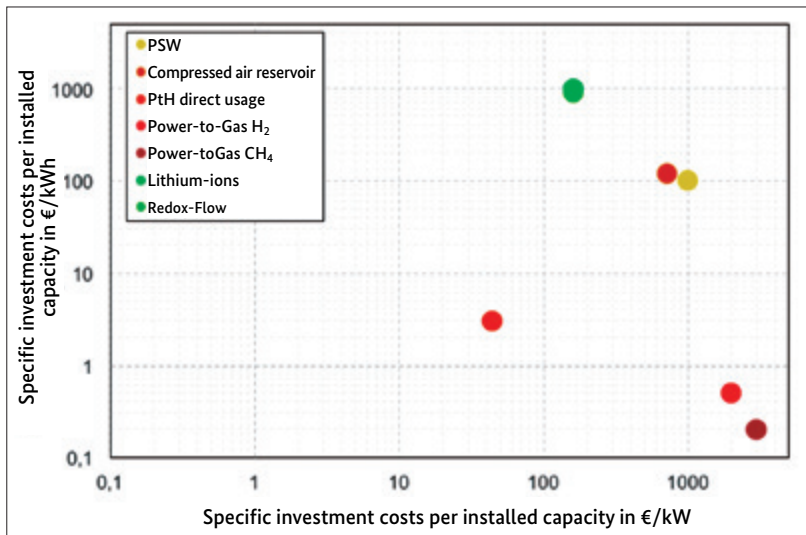

Fig. 50: Comparison of energy storage systems (batteries, compressed air energy storage (CAES), pumped storage hydroelectricity (PSH) and power-to-gas (PtG)) plotted as a function of the specific investment cost per unit of power output (€/kW) and the specific investment cost per installed unit of stored energy (€/kWh). [7].

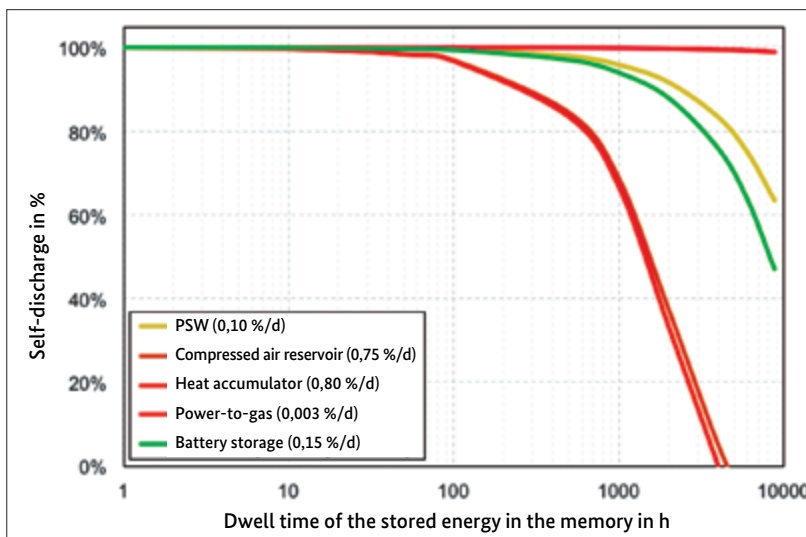

Fig. 51: Self-discharge profiles of selected energy storage technologies over the course of a year [7].

stored heat into electricity. Another factor and that has not been considered up until now is the self-discharge rate that provides an additional limit on long-term storage capabilities. Figure 1.6 shows the amount of energy available in the energy storage system over the course of a year. It can be seen that the high self-discharge rates in thermal energy storage systems (0.8 % per day) makes them essentially unsuitable for long-term energy storage. In terms of this particular criterion, power-to-gas technology would be the best choice for long-term storage requirements.

Figure 52 illustrates the areas of application of energy storage systems as a function of their storage capacity (total energy stored) and discharge times. For guidance purposes, the diagram also includes the annual energy consumption levels for a range of different consumers, from an individual household to a major city like Berlin. The data used to compile the data clouds associated with the different storage technologies relates to plants or systems currently installed in Germany.

Fig. 52: Comparison of the discharge times and storage capacity of different energy storage technologies [7].

The longest discharge times and highest storage capacities are associated with power-to-gas technology. After PtG systems come mechanical energy storage and district heating storage systems. Batteries, in contrast, are useful as storage systems when the timeframe is hours or days. Their storage capa-

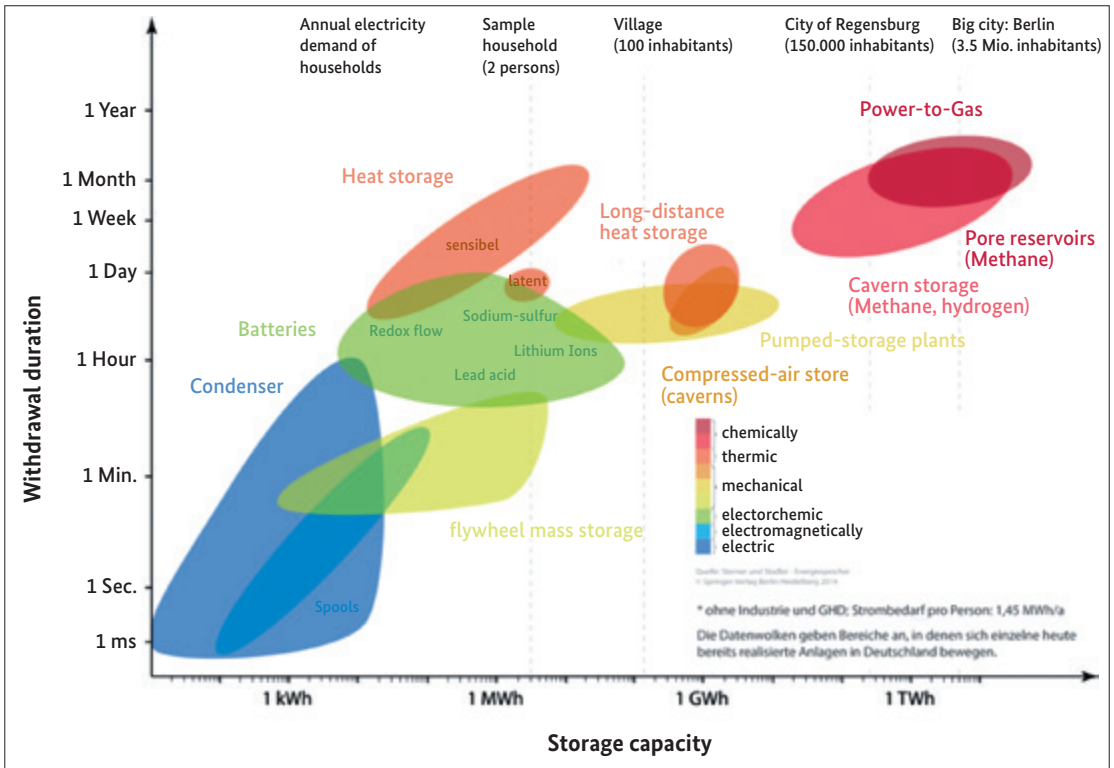

city ranges from a few kilowatt hours to several hundred megawatt hours so that they begin to overlap with pumped hydro systems. Despite their short discharge times and low storage capacities, flywheel storage systems (spinning reserves), capacitors and inductors are important components from a power engineering perspective as they offer both fast response times and a high number of discharge cycles, which are essential in applications such as reactive power compensation. Thermal energy storage systems are used in domestic applications (e.g. solar hot-water storage tanks) and in large-scale applications such as district heating networks or solar power plants (e.g. molten salt storage systems).

Each of the storage technologies referred to above is used in a variety of applications within the energy sector. From an engineering point of view, Germany has sufficient storage capacity for the ongoing energy transition. Developing and utilising these technologies efficiently requires policymakers to establish a roadmap by compiling an appropriate policy framework (see Section 2.1.5.2).

The data and information contained in Figure 50, Figure 51 and Figure 52 can be combined to calculate energy storage costs. Quantifying costs in this way enables the different types of storage systems to be deployed economically within the energy sector.

Fig. 53: Comparison of electricity storage costs for different energy storage technologies [7].

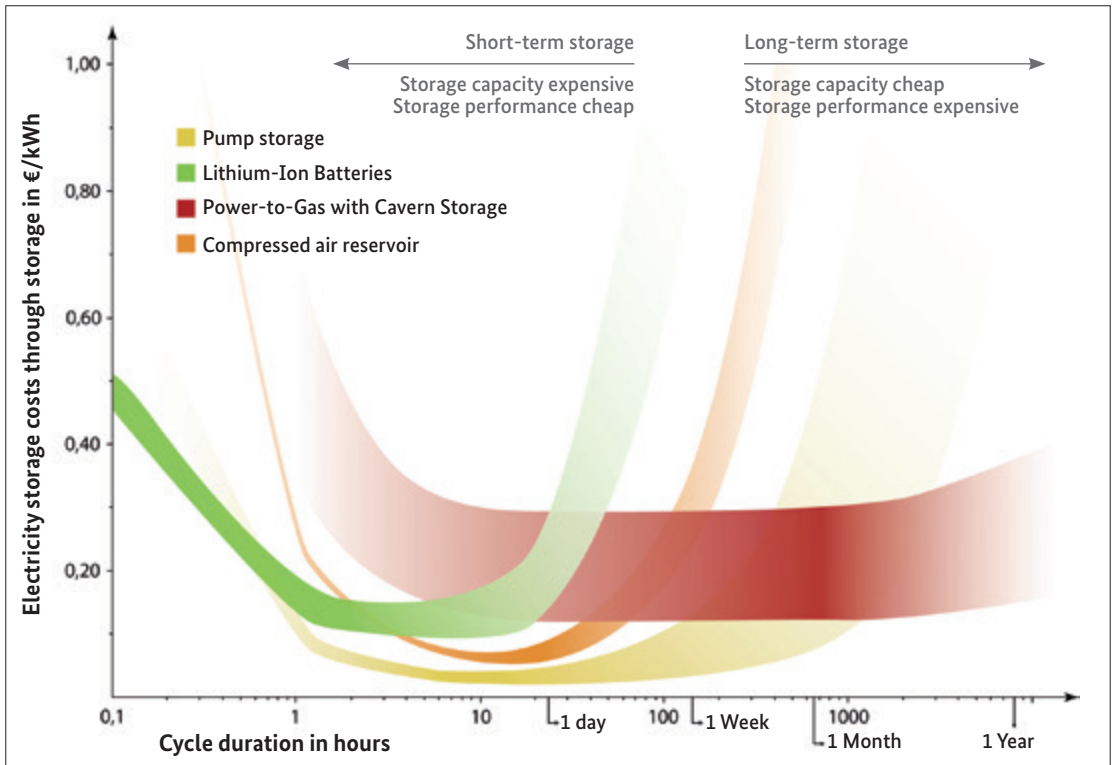

Figure 53 shows the costs of storing electricity in batteries (lithium ion), pumped hydro, power-to-gas and compressed air systems. The darker coloured regions show the areas in which the corresponding storage technology is currently used. The transparent parts of the curves indicate those areas in which the storage technology is of limited suitability either because of inherent characteristics of the technology, its price or external technical restrictions.

The application ranges shown reflect the ranges of the efficiencies, self-discharge rates and the specific costs (€/kW and €/kWh) of the individual technologies. As technical improvements and greater cost-efficiency are to be expected, particularly in the case of battery and power-to-gas systems, the associated curves are projected to shift downward in the coming years. For power-to-gas, the technology used to reconvert gas back into electricity was assumed to be a combined-cycle power plant.

Decades of development and use has led to a situation in which pumped hydro-electric storage is still frequently the cheapest means of energy storage across a wide range. In order to ensure that only the costs associated with electricity storage are shown, an electricity purchase price of 0 cent/kWh was assumed.

### 2.1.3 Storage requirements in the German energy system

The energy storage requirements in the German energy system depend on numerous factors. Restricting discussion of energy storage systems to the electricity sector leads to the conclusion that power-to-X (particularly power-to-gas) technology is superfluous to current requirements, as the necessary levels of excess RES electricity will only become available when the proportion of RES-E in the electricity mix is 60–80 %, and that the costs are too high compared with alternative technologies. It is also often stated by opponents of grid expansion that power-to-gas technology, which involves converting electric power into gas, transporting the gas via the existing gas infrastructure and then re-converting it to electricity, would make any expansion of the electricity distribution network obsolete. Although technically possible, such a scheme would be uneconomical at present. The energy storage technology power-to-gas will therefore complement but not replace grid expansion.

However, as part of the broader family of power-to-X technologies, power-to-gas will contribute to the decarbonisation of numerous industrial sectors (electricity, heat generation, transport and chemicals) and will therefore play a central role in achieving energy transition. It is therefore important that the foundation is laid for the future positive development of PtX techno-

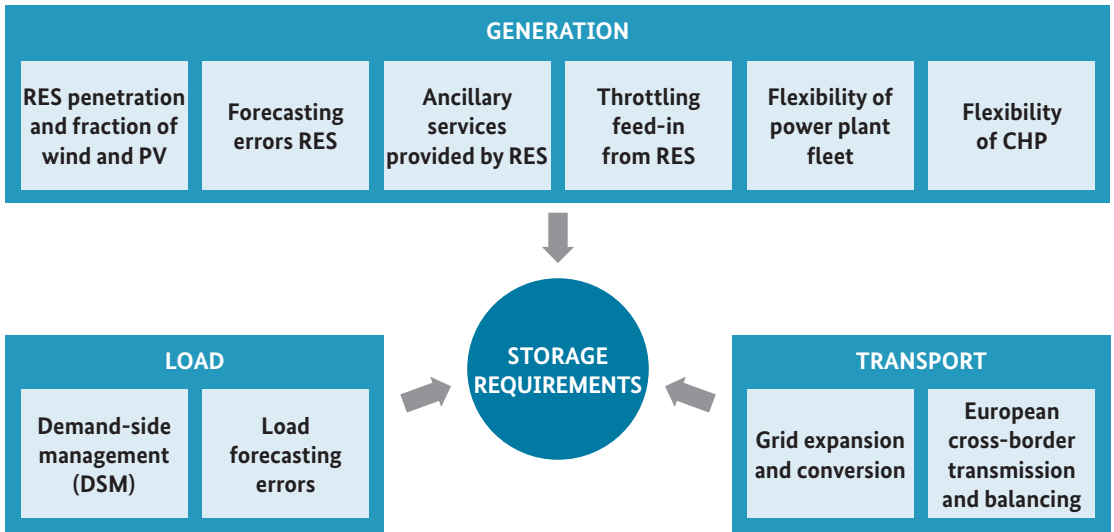

ologies so that they can be fully exploited when and as required within the burgeoning renewables-based energy system.

PtX could also potentially contribute to flexibility, but the flexibility options offered by power plants, networks and load management strategies are currently more cost-effective. However, a number of flexibility options are not progressing as originally forecast. Grid expansion, for example, is facing a lack of public acceptance (see Section 2.1.3.2) and it is therefore becoming more likely that PtX will be deployed earlier than originally expected (see Section 2.1.3.3). Figure 54 illustrates the factors that influence demand for energy storage. It clearly shows that the need for such storage systems does not solely arise when there is a high proportion of renewable energy in the energy mix and that these storage systems can provide many of the ancillary services currently supplied by other players such as power plants.

### 2.1.3.1 Energy storage systems as a flexibility option

Future energy systems with a high proportion of wind and solar electric power will be dependent on accurate generating forecasts. They require flexible technical solutions that enable synchronisation of the generation and consumption of electric power. These flexible technical units are referred to as flexibility options and can be divided into the following categories:

- Generation (flexible power plants, throttling feed-in)
- Consumption (load management)
- Energy distribution (networks)
- Storage (energy storage systems).

Fig. 54: Factors affecting demand for energy storage: Generating large quantities of renewables is not the only factor driving demand for energy storage systems [7].



Energy storage systems primarily provide temporal flexibility, while energy distribution networks provide spatial flexibility. Energy storage technology and energy distribution networks are therefore clearly distinguishable in terms of functionality. One exception to this is PtX technology, which in addition to providing the necessary temporal flexibility can also be used to compensate for spatial deficiencies. Electricity from a renewable energy source (RES-E) is converted into a chemical energy carrier, say a gas or a fuel, in which the energy is stored. The energy can then be transmitted by transporting the chemical via the existing gas or fuel transport infrastructure. When the gas is converted back into electricity, the power-to-gas technology has provided both temporal flexibility through its function as an energy storage medium, and spatial flexibility through being transported via the gas distribution network. However, compared with grid expansion, PtG technology is still an inferior solution from both a technical and economic perspective grid, and is only superior in terms of public acceptance.

Fig. 55: Excess electricity in different scenarios: spatial flexibility (networks) and temporal flexibility (storage) PtG/PtX plays a special role as it can function both as a storage technology and can provide spatial flexibility by transmitting the energy carrier via the gas or fuel distribution infrastructure [7].

The demand for storage technology can be assessed by weighing up all of the flexibility options in terms of technical, economic and/or social suitability factors (acceptance) [7].

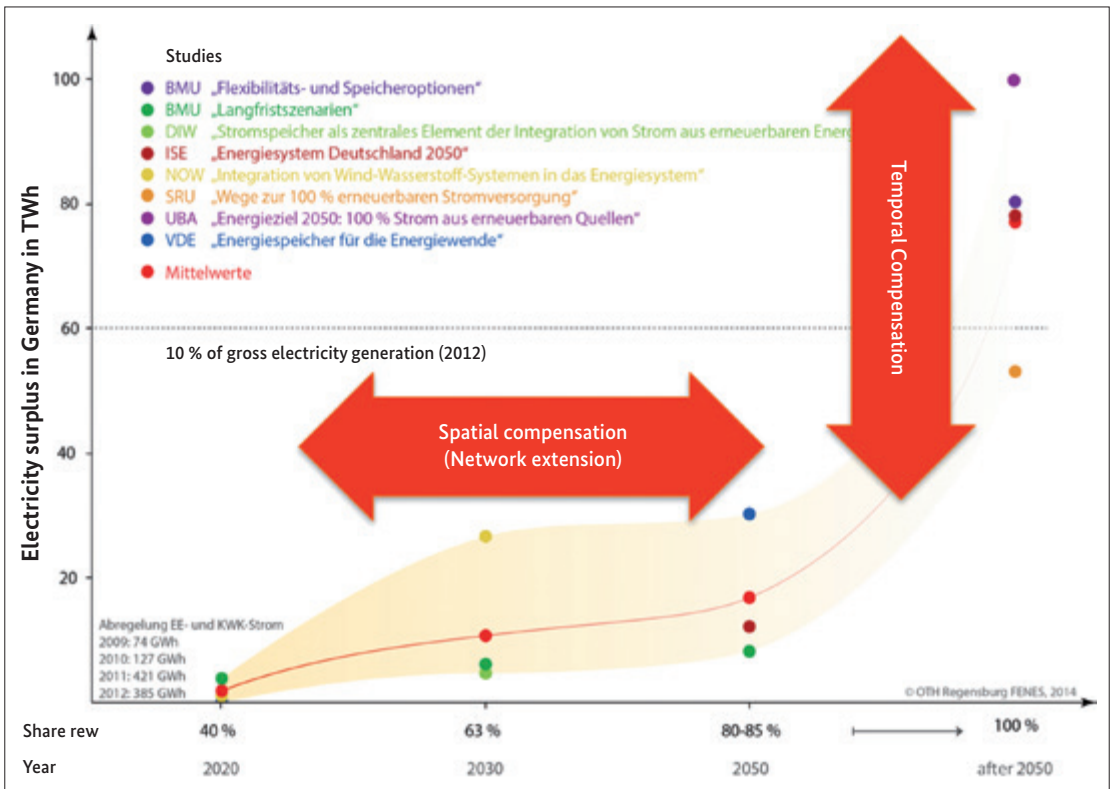

### 2.1.3.2 Storage versus grid expansion

Storage systems and distribution networks fulfil two distinct functions within the energy sector: the temporal function (storage) and the spatial function (distribution networks). Both functions and the flexibility options that they offer are of major significance to the success of the energy transition and should not be played off against one another<sup>[8]</sup>.

Figure 55 shows that the amount of surplus electricity produced will be comparatively small until renewable sources make up a large proportion of the national energy mix. Only after renewable generation constitutes more than 80% of overall electricity production can one expect a large and significant increase in excess energy generation. If a situation arises, possibly fuelled by the needs of international electricity trading, in which the networks reach their limits with respect to electric power distribution, energy storage systems can offer temporal flexibility by absorbing the excess energy that would otherwise be lost.

The expansion of the electricity distribution networks is meeting considerable public resistance in many of the affected regions. To ensure that the energy transition can proceed through to completion, it therefore seems expedient to create backup options in the event that the more technologically and economically favoured approaches cannot be implemented as originally planned.

Fig. 56: Comparison of the planned or simulated extension of the German electricity grid versus the actual extension built so far. (Source: compiled by the authors using data from [9–16]).

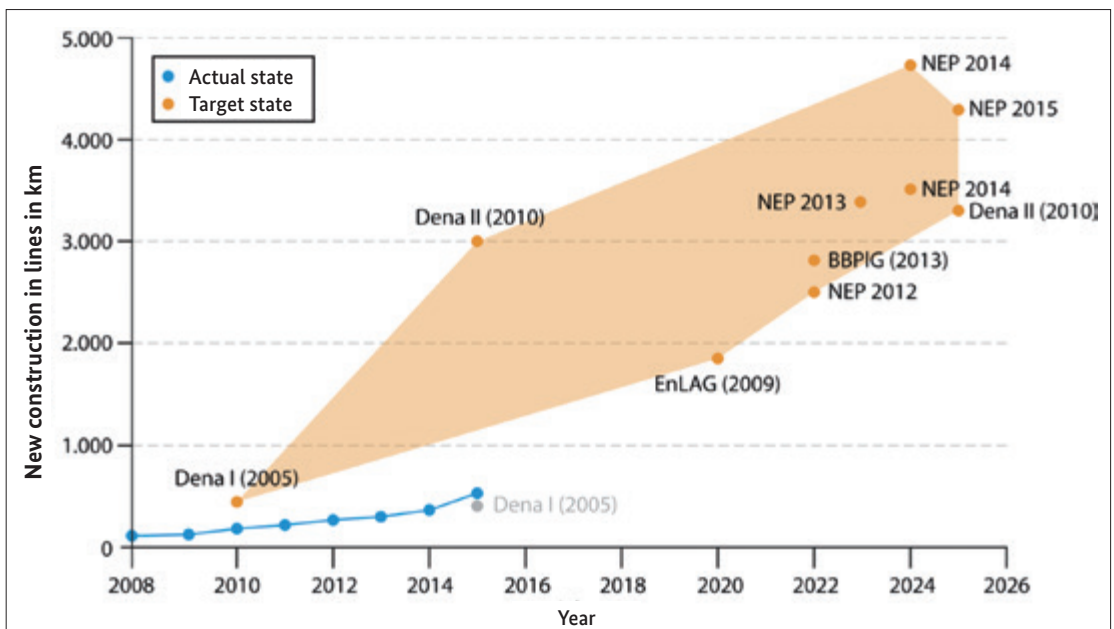

A number of studies have been performed to simulate and forecast the necessary grid expansion. Figure 56 presents data from these studies and compares grid expansion forecasts with what was actually built up to 2016. The blue curve presents actual additions to the network in kilometres for the years shown. The orange area represents the range of required grid expansion as forecast by a number of studies and follow-up studies [9–16]. Although current expansions to the grid exceed the grid size requirement forecast in Grid Study I that was published in 2005 by dena, the German Energy Agency, when the study was published, the increase in renewable energy sources experienced over the last decade had not yet begun. The follow-up Grid Study II in 2010 from dena identified a significantly higher demand for new power networks. The extension of 531 km that has been added to the German electricity grid since 2008 is significantly less than projected demand for roughly an extra 3000 km.

The expected continued stagnation in grid expansion work, in part due to the low level of public acceptance (there are currently more than 150 action committees fighting planned grid extensions in Germany), is a further factor jeopardising attainment of Germany’s stated climate goals. The idea of slowing growth in renewable energy production while grid expansion is delayed, as is proposed in the 2017 revision of the German Renewable Energy Sources Act [17, 18], is not a particularly constructive approach. A better strategy would be to initiate alternatives to grid expansion that make use of flexibility options that enjoy greater public acceptance, such as PtX technology, as this would allow production of renewable energy to continue at the required level. Only this type of approach will ensure that adequate quanti-

Fig. 57: Electrical energy discarded as a result of feed-in management interventions (throttling feed-in from renewable sources) and the resulting compensation payments for RE plant operators in millions of euros per year. (Source: compiled by the authors using data from [19–29]).

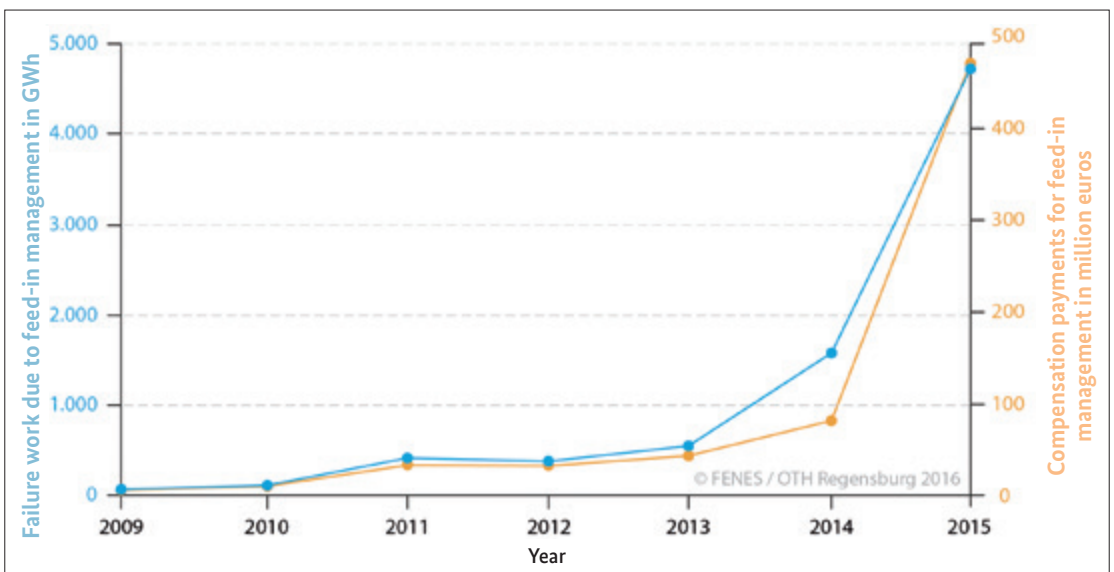

ties of renewable energy are available for decarbonising other industrial sectors. Ultimately, the critical element here is that national and global climate action goals are met in order to curtail drastic and hugely expensive changes to the environment.

### 2.1.3.3 Sector coupling as a grid expansion back-up option

The delay in grid expansion (see Section 2.1.3.2) is not only hampering further growth in the production of renewables, it is also driving up energy system costs, particularly by raising grid usage charges. The lack of grid infrastructure has led to a significant increase in electricity from renewable sources being discarded as a result of feed-in management interventions. Despite restricting feed-in from renewable sources, the RE plant operators are paid as if the electricity had in fact been fed in to the grid and used. In 2010, the amount of energy lost due to discarded RES-E was 127 GWh; in 2015 this had increased more than thirty-fold. The increase in compensation payments during this same period was even higher, rising by a factor of 47. This development is depicted graphically in Figure 57.

Other costs passed on to the consumer via grid charges are redispatch costs. The term 'redispatch' is used to mean the throttling of feed-in at one end of an overloaded network and simultaneously ordering power plants to produce more electricity at the other end. Redispatch measures are used to overcome bottlenecks in the grid. However, compensation has to be paid not only to the power plant operator whose facility is being temporarily shut down, but also to the producer being ordered to generate extra power.

Fig. 58:  
Development of redispatch interventions in Germany. The figure shows the costs of redispatch, the quantity of energy involved and the cumulative annual duration of such interventions.  
(Source: compiled by the authors using data from [19–29])

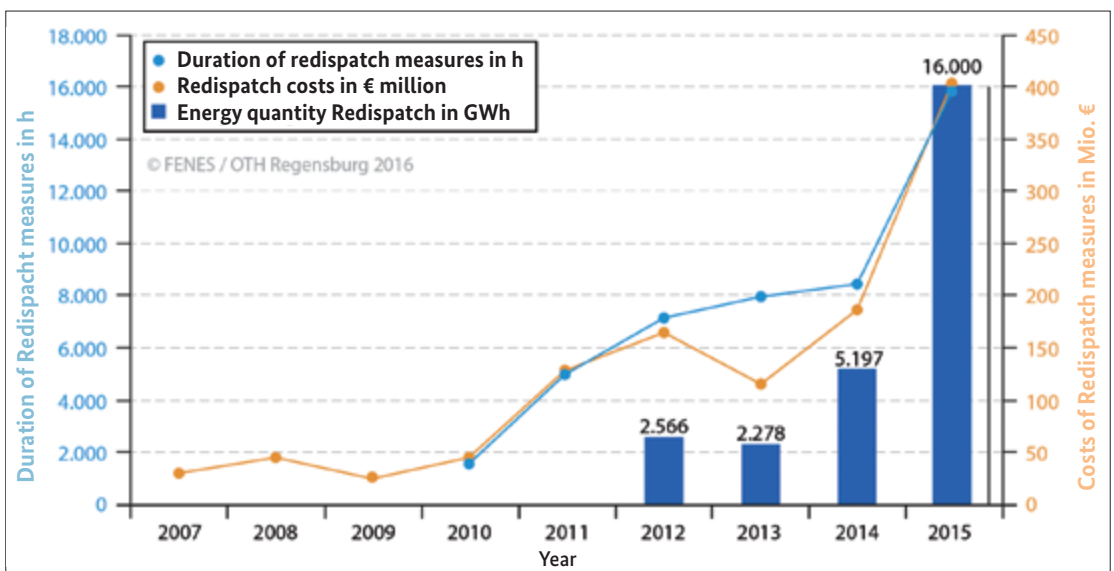

Figure 58 shows how redispatch interventions have grown in recent years by using the available data to plot the duration, cost and energy involved. As with feed-in management costs, redispatch costs also rose strongly in 2014 and 2015. The duration of redispatch measures and the quantities of energy involved follow the same trend.

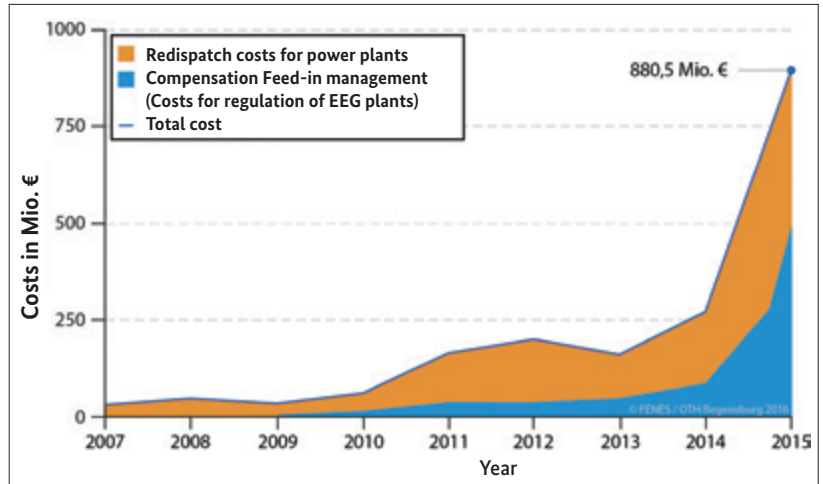

Fig. 59: Development of total costs for redispatch and feed-in management interventions. (Source: compiled by the authors using data from [19–29])

The rise in the total costs for redispatch and feed-in management interventions (see Figure 59) demonstrate the urgent need to create back-up measures and other flexibility options that can compensate for current insufficiencies in grid capacity.

One way of achieving this is to use PtX technology to improve inter-sector coupling. If PtX systems with the capability of reducing grid loading by around 0.5 GW are installed and an annual capacity charge of € 2000 per kilowatt is assumed, cost savings totalling about €1 billion per year could be achieved in the electricity sector [30].

This would represent a 17-fold increase compared to current levels of PtX usage in Germany [7]. Germany could exploit this to maintain its technology leadership in PtX energy storage solutions and by developing sector coupling could also promote decarbonisation in all industrial sectors and thus help to achieve the country’s stated climate action targets.

### 2.1.4 Potential areas of application of power-to-X technology in sector coupling

The many ways that power-to-X technology can be utilised indicate its versatility in delivering a fully renewables-based electricity sector. Of particular

relevance in this regard is its use in sector coupling. The potential of PtX systems has been evaluated for the electricity, transport and chemicals sectors in a study led by FENES for the think tank Agora Energiewende ('Electricity storage technologies in Germany's energy transition' <sup>[30]</sup> based on the study by the Federal Environmental Agency UBA 'A greenhouse gas-neutral Germany in 2050' <sup>[31]</sup>) with projections based on a progressive and on a conservative estimate of future development. The study commissioned by Greenpeace Energy 'Significance and Necessity of Wind-Gas for the Energy Transition in Germany' [8] provides estimates of the potential importance of power-to-gas systems primarily for the electricity sector.

PtX is, in principle, competing with the use of biomass as a source of energy and material. Given the competition to use arable land to grow food and animal feed, there is only limited potential to cultivate biomass for energy recovery. In most scenarios, biomass is predominantly used as a renewable source of raw materials. When used as a construction material, cultivated biomass reduces demand for cement and iron. Only waste biomass is used for energy generation <sup>[32, 33]</sup>.

#### 2.1.4.1 Potential uses in the electricity sector

The demand for and deployment of PtX technology – particularly power-to-gas – for storing electrical energy depends upon the available quantities of excess energy from renewable sources (see Section 2.1.3). In order to estimate the maximum demand for power-to-gas in an energy system fed entirely by renewable sources, a scenario is modelled in <sup>[8]</sup> in which there are no other flexibility options other than PtX. According to the calculated projections, 130 TWh of excess electricity from renewable sources will be generated in 2050 and this energy will need to be integrated into the electricity sector. The electricity generating plants will be operated exclusively with this excess energy and not with dedicated power-to-gas facilities. The utilisation of these PtG facilities will therefore be a moderate 134 GW. It is estimated that 66 GW of power will be required by gas-fired power plants to reconvert the gas to electricity.

This can be regarded as the worst-case scenario should the expansion of all alternative flexibility options not progress as forecast. Even if the future expansion of PtG technology is less extreme than discussed above, results show that over the medium to long term large amounts of power and storage capacity will need to be provided by flexibility options.

Over the long term, PtG reduces the overall costs of the electricity system and is essential for the '100% renewable' goal, which will be simply unattainable without sector coupling via PtG <sup>[8]</sup>.

Other studies, that allow PtG to compete with other flexibility options also identify the need for PtG or other long-term storage technologies in 2050. If grid expansion were to proceed at the projected required rate, and if a variety of flexibility options are used, the demand for long-term storage solutions sinks to 8–16 GW depending on the assumptions made. While this level of demand is significantly below the worst-case scenario in [8], it is still far from negligible and remains highly relevant for forward planning strategies for the energy system.

### 2.1.4.2 Potential uses in the heating sector

The energy requirements in the heating sector can be reduced by improved energy efficiency (particularly by improving the energy efficiency of buildings and by raising efficiency standards) and can be met primarily through the use of electrical heat pumps. The potential benefits of coupling the sectors electricity and heating (‘power-to-heat’) are described in detail in a number of publications, including ‘Interaction between RES electricity, heating and transport’ [5], which was issued by the German Federal Ministry for Economic Affairs and Energy. These benefits are not discussed further in the present analysis as the focus here is on the use of PtX processes in the electricity and chemical sectors. Coupling between the electricity and heating sectors offers considerable potential for the optimisation of heating networks, CHP plants, industrial processes and the supply of heating and cooling energy in buildings.

### 2.1.4.3 Potential uses in the transport sector

Electricity can be used in the transport sector either directly to power electric vehicles (‘e-mobility’) or indirectly by converting it via PtX into fuels that

Fig. 60:  
Hydrogen is the starting point for a great many of the raw materials used in industry today. (Source: compiled by the authors)

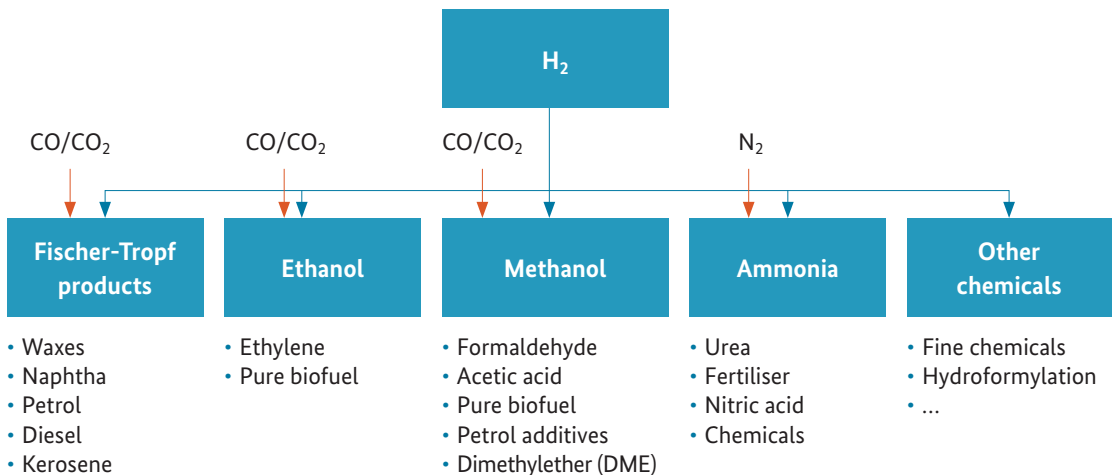



can be stored, distributed and ultimately used in combustion engines or fuel cells. Forecasts indicate that the disadvantages associated with the low energy density of vehicle batteries will no longer be a problem for cars in the near future. Other modes of transport, such as road freight, shipping and air transport, will, however, continue to be reliant on fuels with high energy densities. Although concepts are currently being developed for the direct use of electricity for these modes of transport, e.g. overhead contact lines for road freight vehicles, there is no indication as yet when this sort of technology might be introduced.

Forecasts of a minimum and a maximum deployment of PtX technology in the transport sector for the period up to 2050 are presented in Figure 61. The maximum amount of electric power to be provided by PtX was calculated by estimating the total energy requirements of the transport sector minus that needed for e-mobility<sup>[31]</sup>. This corresponds to about 75 GW of power in 2050 assuming a plant utilisation rate of 6000 full-load hours. If a more conservative estimate of the growth in PtX technology is assumed with stronger expansion of e-mobility solutions, the minimum amount of power from PtX technology in 2050 is projected to be about 22 GW.

#### 2.1.4.4 Potential uses in the chemical sector

The chemical industry needs considerable amounts of fossil-based raw materials (particularly crude oil and natural gas), which will need to be substituted by renewable feedstocks in order to achieve a fully renewables-based energy system. In 2013, the chemical sector was responsible for only a small fraction of the total level of primary energy consumption in Germany

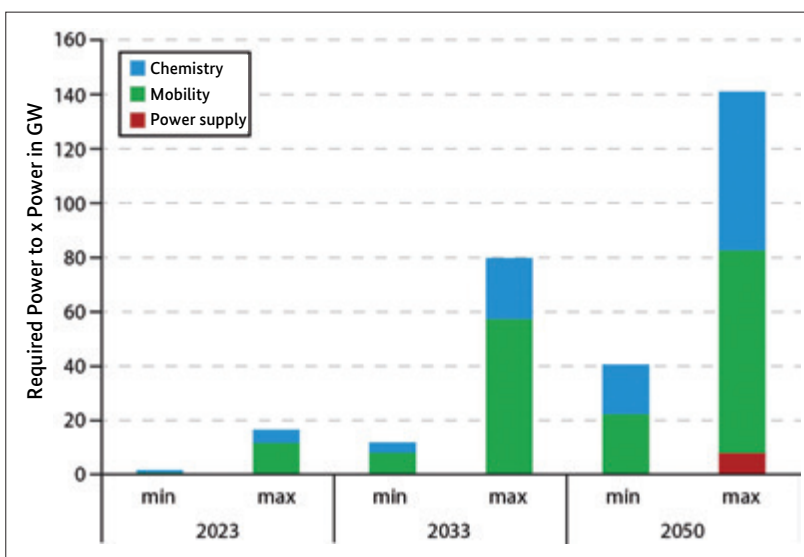

Fig. 61: Possible development in the expansion of PtX capacity in Germany. (Source: authors' own study [30])



(6.8 %, see Figure 46). Its importance will, however, increase over time and by 2050 this percentage fraction will have doubled as a result of efficiency improvements in the other three sectors. The demand for primary energy sources for non-energy applications in the chemical sector is forecast to grow by 0.7 % per year, when productivity and efficiency improvements are taken into account, with demand totalling 293 TWh in 2050. If this demand is met by renewables, the maximum demand for installed power from PtX systems is forecast to be 58 GW assuming a plant utilisation rate of 6000 full-load hours (see Figure 61 and <sup>[30]</sup>). If conversion losses are taken into account, this corresponds to an annual demand for electrical energy of 350 TWh, which is just over half of Germany's electricity demand in 2015. In a conservative estimate, PtX technologies will cover around 30 % of the demand for raw materials in the chemical sector.

The PtX facilities will be powered by the increasing levels of excess electricity from renewable sources and will be supplemented by PtX systems powered by renewable energy that are specifically designed for chemical feedstock production. This additional demand for renewable energy to produce raw materials can also be met by importing feedstock from PtX sites that can exploit very favourable renewable energy sources. One such example is the power-to-methanol plant in Iceland that operates at high capacity utilisation rates and uses geothermal electric power and CO<sub>2</sub> captured from geothermal flue gas to produce methanol at a very competitive price.

Hydrogen or synthesis gas can be used in the chemical industry as the starting point for producing many of the feedstock materials that are themselves the basic chemicals used in many areas of industry (see Figure 60).

Ethylene, for example, is the largest volume basic organic compound produced in Germany (5 million metric tons in 2014 <sup>[34]</sup>), a large proportion of which is used for manufacturing plastics. Another example is ammonia (2.5 million metric tons per year), which is manufactured from nitrogen and hydrogen and is the basic feedstock for all nitrogen-containing compounds. Much of the ammonia produced is used in the manufacture of fertilisers <sup>[34]</sup> and it, like ethylene, plays a central role in today's world.

#### **2.1.4.5 Summary of potential future demand for PtX technology in the electricity, transport and chemical sectors**

Even conservative forecasts predict that by 2050 around 40 GW of PtX storage capacity will be required in Germany. This demand is shared approximately equally between the mobility and chemical sectors. (see Figure 61).

Even under conditions that encourage PtX development (favourable cost trends and early market maturity), if grid expansion proceeds at the ideal rate,

PtX technology will only be deployed at a later stage and for long-term energy storage. If, however, grid expansion is severely delayed, as seems likely from the present perspective, then the prevailing conditions will be different and PtX technology will become established at an earlier date (See Section 2.1.3.2).

The arguments presented above can be summarised as follows:

- The decarbonisation of the chemical industry will require switching from fossil-based to renewables-based raw materials and feedstocks. As decarbonisation proceeds, there will be an increasing need to use PtX technology to convert low-cost, low land-use wind and solar power into basic chemicals.
- Biomass is unable to provide a sustainable and environmentally compatible source of raw materials and transport fuels for the chemical industry and the transport sector.
- If the chemical industry continues to grow at 0.7 % per annum, the amount of electrical energy required for power-to-X facilities has been estimated to rise to 350 TWh for an installed capacity of approximately 60 GW. This corresponds to approximately half of the electricity currently consumed in Germany.

Fig. 62: A CO<sub>2</sub>-neutral energy system for the sectors electric power generation, heat, transport and process industries based on access to power-to-X technology (power-to-heat, power-to-gas, power-to-liquid, power-to-chemicals), CCU and sources of renewable energy. (Source: compiled by the authors [7])

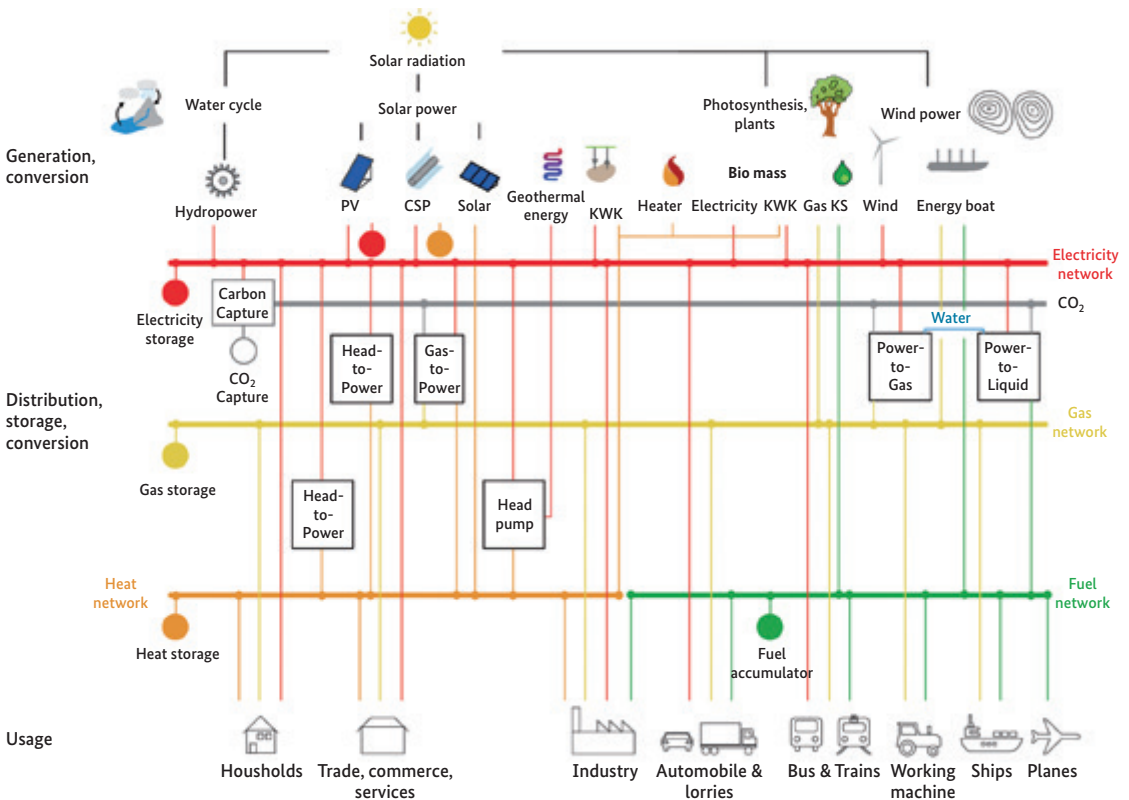

- Complete decarbonisation of the transport sector by 2050 will generate additional demand for renewable electrofuels, which, depending on the electricity source, will result in an additional need for 22–75 GW of power-to-X capacity.
- The provision of additional electricity for power-to-X use is a challenge for which potential solutions exist. It seems very probable that PtX products will be imported from regions that can produce RES electricity very cheaply.
- The deployment of PtX technology will lower costs within the entire energy system and will enable Germany to achieve its long-term goals of a fully renewables-based energy supply system and the decarbonisation of all areas of industry that must be achieved if climate change objectives are to be met.

## 2.1.5 A systemic approach to the energy and raw materials system of the future

### 2.1.5.1 A climate-friendly energy system with CCU

This final section will demonstrate how a renewables-based energy system based on wind, solar and hydroelectric power in combination with PtX technologies can be created (see Figure 62, <sup>[2]</sup>).

By recycling CO<sub>2</sub> from the atmosphere or by capturing it from the flue gas streams from the industrial combustion of (renewable) PtX products, it is possible to create a global, CO<sub>2</sub>-neutral energy system that is based solely on energy generated from renewable sources. By using PtX and CCU technologies for sector coupling, energy networks (electricity, gas, fuel, heat) can be combined with different energy storage systems to meet future demand for electricity from renewable energy sources.

Apart from the direct use of electricity in heat pumps and electric vehicles, chemical energy storage systems and energy conversion processes play a key role. Water, converted into hydrogen and CO<sub>2</sub> will be used as a raw material to power plants and equipment in all industrial sectors, such as CHP plants in the heating sector, gas turbines in the electricity supply sector, gas-powered and fuel-cell vehicles in the transport sector, or feedstock supply processes for manufacturing plastics in the chemical sector.

In the heating and transport sectors, most applications are being converted for use with renewable electricity. PtX technology can supply the high energy density fuels like renewables-based methane, methanol, diesel or kerosene that are needed for powering road freight, shipping or air transport services.

This multiple interlinking of sources and consumers via networks, converter technologies and storage systems will be added to in future by novel technologies that are currently unknown or undeveloped. One possible option for energy generation is the production of fuels and raw materials on 'green ships' that makes use of a combination of wind power, wave power and PtX. This would allow the large quantities of unused sources of renewable energy available on the open sea to be converted into easily transported energy carriers that can be exploited by means of the existing hydrocarbon infrastructure and processing technologies. Unconventional approaches of this type also have the advantage that they avoid the public acceptance problems associated with land-based energy generation and transport, as they have little effect on the landscape and do not compete with land use for cultivating food or animal feedstuffs.

### 2.1.5.2 Necessary realignment of energy policy

Of the three elements 'generation', 'distribution/conversion/storage' and 'consumption', the focus of energy policy has so far been on power generation. As renewable energy becomes an increasingly significant part of the energy mix, so too does the importance of distribution networks and storage systems and therefore the relevance of sector coupling via PtX. Policy decisions need to be made now to set a course that will ensure the future long-term viability of the energy system. In addition to expanding the electricity distribution network (grid), it therefore seems expedient to develop and enhance inter-sector coupling and PtX technologies.

Using the existing transport and storage infrastructure saves costs, as only the power-to-X technology for storing and converting renewable electricity (power-to-heat, power-to-gas, etc.) needs to be developed. This approach is suitable for gas, heating and transport fuels. Sector coupling requires the use of energy storage technology and is an important backup to grid expansion.

As sector coupling means that the distribution networks for electricity, gas, heating and fuels will complement one another and interact in a synergistic fashion, it is important that future planning work is carried out jointly and collaboratively.

The structure of the surcharge and subsidy system currently used to finance the energy transition in Germany also needs to be reformed. The following rules and constraints make the construction, installation and operation of PtX (particularly power-to-gas) facilities uneconomical:

- Exemption from network charges only when feeding into the grid
- Exemption from energy tax only for companies in the manufacturing sector

- The renewable energy surcharge is payable – in some cases, with the exception of PtG as an electricity storage technology, the surcharge is payable twice (for both the storage and the reconversion stage)
- Cannot be credited as renewable heat or renewable fuel.

Section 27a of the German Renewable Energy Sources Act (EEG) stipulates that a feed-in tariff for renewable energy installations may be included in the auction only if the electricity generated by the installation is not consumed, converted or stored by the installation itself ('self-supply'). This effectively prohibits any intelligent combination of wind power and wind gas. The energy generated by a wind park can either be used for self-supply (no EEG subsidy) or can be fed into the grid (EEG subsidy), but the latter frequently remains unused as a result of grid management interventions that throttle feed-in from renewable sources.

To fully exploit the potential of power-to-gas and sector coupling, the following steps need to be implemented:

- Consolidating and redesigning the energy markets and/or the surcharge system
- Removing barriers between sectors
- Joint planning of consolidated distribution network (electricity-heating-gas) and exploitation of existing synergies
- Establishing CO<sub>2</sub> as a raw material
- Long-term planning for uniform and unifying legislation for the electricity, heating and gas sectors
- Stimulating the importing of renewable raw materials and fuels
- Recognition of renewables-based PtX products in legislation covering renewable heat and renewable fuels.

Power-to-gas will only be needed as a means of storing excess electrical energy in the electricity generating sector once high levels of decarbonisation have been achieved and will therefore complement but not replace grid expansion.

Using PtX plants to reduce grid bottlenecks can create a win-win situation: 'excess electricity' is used and not wasted, grid bottlenecks are removed, use of expensive back-up power plants burning climatically harmful fossil fuels can be avoided and the PtX technology that will anyway be needed later on can gradually become established.

From the current perspective, the main drivers of PtX technology are the decarbonisation strategies in the transport and chemical sectors. Climate policy measures have increased the need for action in these sectors and have boosted demand for climate-friendly fuels and raw materials. Legislation has already been passed regarding electrofuel quotas produced with

renewable energy. At the EU level, the legislation cover the CO<sub>2</sub> emission limits for vehicle fleets, the Renewable Energy Directive (RED) and the Fuel Quality Directive (FQD), which is transposed into German law as an Ordinance for the Implementation of the Federal Immission Control Act (BImSchV).

As production costs for renewable electricity in Germany are higher than in other countries and as these costs are very strongly affected by state-levied surcharges, the installation and operation of a PtX facility in Germany is currently uneconomical. Over the medium term it seems more likely that the stipulated national quotas and climate targets in the transport sector will be met by imports of renewable PtX products. There are sites around the world at which renewable electricity can be generated from wind, solar, hydro and geothermal power for between € 0.02 and € 0.03 per kWh. The production of PtX products is correspondingly cheap. The associated process engineering and technology is, however, highly complex, but represents an economic opportunity for an engineering nation like Germany.

Nevertheless, to be able to exploit the export potential offered by PtX technology, it first needs to be established in the domestic market. This can be achieved by continuing to build national demonstration projects in areas where grid bottlenecks arise. These PtX systems could be operated in the German electricity sector when electricity prices are low or negative and could be used in redispatch interventions to eliminate bottlenecks. This would enable the surcharges incurred to be compensated by grid operations.

While this would be a practicable and economically viable approach, it does not eliminate the need over the medium to long term to reform the surcharge system being used to subsidise Germany's energy transition.

#### Source:

- [1] M. Specht, M. Sterner, B. Stuermer, V. Frick und B. Hahn: Renewable Power Methane – Stromspeicherung durch Kopplung von Strom- und Gasnetz – Wind/PV-to-SNG, Germany 10 2009 018 126.1.
- [2] M. Sterner, "Limiting global warming by transforming energy systems," Dissertation, Universität Kassel, Kassel, 2009
- [3] Nitsch et al., "Leitstudie 2011: Langfristszenarien und Strategien für den Ausbau der erneuerbaren Energien in Deutschland bei Berücksichtigung der Entwicklung in Europa und global," DLR; IWES; IfnE, Berlin, 2012
- [4] UBA, *Energieziel 2050: 100 % Strom aus erneuerbaren Quellen: Vorabdruck für die Bundespressekonferenz am 7. Juli 2010*: Zentral- und Landesbibliothek Berlin; ZLB. Senatsbibliothek, 2010.
- [5] Norman Gerhardt, Fabian Sandau, Angela Scholz, Henning Hahn, Patrick Schumacher, Christina Sager, Fabian Bergk, Claudia Kämper, Wolfram Knörr, Jan Kräck, Udo Lambrecht, "Interaktion EE-Strom, Wärme und Verkehr: Analyse der Interaktion zwischen den Sektoren Strom, Wärme/Kälte und Verkehr in Deutschland in Hinblick auf steigende Anteile fluktuierender Erneuerbarer Energien im Strombereich unter Berücksichtigung der europäischen Entwicklung," Ableitung von optimalen strukturellen Entwicklungspfaden für den Verkehrs- und Wärmesektor, Fraunhofer IWES, Kassel, 2015.
- [6] M. Pehnt, M. Sterner, N. Gerhardt und U. Lambrecht, "Fahrplan Energiewende," IFEU, Fraunhofer IBP, OTH Regensburg, 2012.
- [7] M. Sterner und I. Stadler, *Energiespeicher: Bedarf, Technologien, Integration*. Heidelberg, Dordrecht, London, New York: Springer Vieweg, 2014.

- [8] M. Thema, M. Sterner, F. Eckert, T. Lenck und P. Götz, "Bedeutung und Notwendigkeit von Windgas für die Energiewende in Deutschland," Forschungsstelle für Energienetze und Energiespeicher (FENES), OTH Regensburg, Hamburg, Regensburg, 2015.
- [9] 50Hertz Transmission GmbH, Amprion GmbH, TenneT TSO GmbH und TransnetBW GmbH, "Netzentwicklungsplan Strom 2012: 2. überarbeiteter Entwurf der Übertragungsnetzbetreiber," 2012. <http://www.netzentwicklungsplan.de/netzentwicklungsplaene/2012>. Aufgerufen am 03.05.2016.
- [10] 50Hertz Transmission GmbH, Amprion GmbH, TenneT TSO GmbH und TransnetBW GmbH, "Netzentwicklungsplan Strom 2013: 2. Entwurf der Übertragungsnetzbetreiber," 2013. [Online] Available: <http://www.netzentwicklungsplan.de/netzentwicklungsplaene/2013>. Aufgerufen am 03.05.2016.
- [11] 50Hertz Transmission GmbH, Amprion GmbH, TenneT TSO GmbH und TransnetBW GmbH, "Netzentwicklungsplan Strom 2014: 2. Entwurf der Übertragungsnetzbetreiber," 2014. <http://www.netzentwicklungsplan.de/netzentwicklungsplaene/2014>. Aufgerufen am 03.05.2016.
- [12] 50Hertz Transmission GmbH, Amprion GmbH, TenneT TSO GmbH und TransnetBW GmbH, "Netzentwicklungsplan Strom 2025, Version 2015: 2. Entwurf der Übertragungsnetzbetreiber," 2015. [http://www.netzentwicklungsplan.de/\\_NEP\\_file\\_transfer/NEP\\_2025\\_2\\_Entwurf\\_Teil1.pdf](http://www.netzentwicklungsplan.de/_NEP_file_transfer/NEP_2025_2_Entwurf_Teil1.pdf). Aufgerufen am 03.05.2016.
- [13] *Gesetz zum Ausbau von Energieleitungen: EnLAG*, 2009.
- [14] *Gesetz über den Bundesbedarfsplan: BBPlG*, 2013.
- [15] DENA, "dena-Netzstudie II," Berlin, 2011. [http://www.dena.de/fileadmin/user\\_upload/Presse/studien\\_umfragen/Netzstudie\\_II/Endbericht\\_dena-Netzstudie\\_II.pdf](http://www.dena.de/fileadmin/user_upload/Presse/studien_umfragen/Netzstudie_II/Endbericht_dena-Netzstudie_II.pdf). Aufgerufen am 03.09.2013.
- [16] Deutsche Energie-Agentur, "dena-Netzstudie I: Energiewirtschaftliche Planung für die Netzintegration von Windenergie in Deutschland an Land und Offshore bis zum Jahr 2020," Berlin, 2005.
- [18] Niklas Schinerl, "Auf der Bremse: Greenpeace kritisiert EEG-Reform," in *greenpeace.de*
- [19] Bundesnetzagentur, "3. Quartalsbericht 2015 zu Netz- und Systemsicherheitsmaßnahmen," 08/16.
- [20] Bundesnetzagentur, "Monitoringbericht 2007," Bonn, 2007. [www.bundesnetzagentur.de](http://www.bundesnetzagentur.de). Aufgerufen am 03.05.2016.
- [21] Bundesnetzagentur, "Monitoringbericht 2008," Bonn, 2008. [www.bundesnetzagentur.de](http://www.bundesnetzagentur.de). Aufgerufen am 03.05.2016.
- [22] Bundesnetzagentur, "Monitoringbericht 2009," Bonn, 2009. [www.bundesnetzagentur.de](http://www.bundesnetzagentur.de). Aufgerufen am 03.05.2016.
- [23] Bundesnetzagentur, "Monitoringbericht 2010," Bonn, 2010. [www.bundesnetzagentur.de](http://www.bundesnetzagentur.de). Aufgerufen am 03.05.2016.
- [24] Bundesnetzagentur, "Monitoringbericht 2011," Bonn, 2011. [www.bundesnetzagentur.de](http://www.bundesnetzagentur.de). Aufgerufen am 03.05.2016.
- [25] Bundesnetzagentur, "Monitoringbericht 2012," Bonn, 2012. [www.bundesnetzagentur.de](http://www.bundesnetzagentur.de). Aufgerufen am 03.05.2016.
- [26] Bundesnetzagentur, "Monitoringbericht 2013," Bonn, 2013. [www.bundesnetzagentur.de](http://www.bundesnetzagentur.de). Aufgerufen am 03.05.2016.
- [27] Bundesnetzagentur, "Monitoringbericht 2014," Bonn, 2014. [www.bundesnetzagentur.de](http://www.bundesnetzagentur.de). Aufgerufen am 03.05.2016.
- [28] Bundesnetzagentur, "Monitoringbericht 2015," Bonn, 2015. [www.bundesnetzagentur.de](http://www.bundesnetzagentur.de). Aufgerufen am 03.05.2016.
- [29] Bundesnetzagentur, "2. Quartalsbericht 2015 zu Netz- und Systemsicherheitsmaßnahmen: Drittes Quartal 2015," Bonn, 2016. <http://www.bundesnetzagentur.de>. Aufgerufen am 03.05.2016.
- [30] M. Sterner *et al.*, "Stromspeicher in der Energiewende: Untersuchung zum Bedarf an neuen Stromspeichern in Deutschland für den Erzeugungsausgleich, Systemdienstleistungen und im Verteilnetz," Studie, ef.Ruhr; FENES; IAEW; ISEA, Berlin 050/10-S-2014/DE, September 2014.
- [31] Benndorf *et al.*, "Treibhausgasneutrales Deutschland: im Jahr 2050," THGND 2050, Dessau-Roßlau, 2014.
- [32] FAO, *The State of Food and Agriculture 2008: Biofuels - Prospects, Risks and Opportunities*. Rome: FAO, 2008.
- [33] J. D. Sachs, "Surging food prices mean global instability: Misguided policies favor biofuels over grain for hungry people," (en), *Scientific American Magazine*, vol. May, 2, 2008.
- [34] Verband der chemischen Industrie e.V., *Chemiewirtschaft in Zahlen 2015*. <https://www.vci.de/vci/downloads-vci/publikation/chemiewirtschaft-in-zahlen-print.pdf>. Accessed on: 19.07.16.



## 2.2 sunfire – Liquid hydrocarbons from CO<sub>2</sub>, H<sub>2</sub>O and renewable electricity

BMBF Project FKZ 033RC1110

Project Coordinator: Christian von Olshausen, sunfire GmbH

Project Partner: Universität Bayreuth, Universität Stuttgart, Forschungszentrum Jülich GmbH, ElfER Europäisches Institut für Energieforschung EDF-KIT EWIV, Fraunhofer-Gesellschaft zur Förderung der angewandten Forschung e.V., KERAFOIL Keramische Folien GmbH

### 2.2.1 Pre-project status and background

The Power-to-Liquid project 'sunfire' launched in May 2012. The underlying technical and economic concept had already been examined in an internal study in 2008. The project was therefore conceived considerably earlier than the catastrophe in Fukushima<sup>1</sup> and Germany's subsequent decision to transition to a renewables-based energy sector.

The key process innovation of the sunfire project is high-temperature steam electrolysis. The high-temperature co-electrolysis of CO<sub>2</sub> and steam has an electrical efficiency of more than 85%, is reversible, is compatible with carbon monoxide, and is now one of the core business areas at sunfire GmbH.

The original motivation for the project was primarily to supply liquid transport fuels. The idea was that the carbon for these fuels would not come from crude oil but from CO<sub>2</sub> and the energy stored in these fuels would be from renewable sources. Another driver of the sunfire project was the fact that these liquid fuels provide a means for the global storage and transport of renewable energy.

The switch towards a renewable-based energy sector provided additional motivation for the chemical storage of energy from renewable sources.

The storage of renewable energy is, however, no longer the main driver of the sunfire project. The objective now is to expand the transition from conventional to renewable sources of energy beyond the electricity generating sector and into the chemical industry. The idea is to achieve a gradual transition in which the molecular building blocks that the chemical and petrochemical industries obtain from fossil sources are replaced by chemically

---

<sup>1</sup> 11 March 2011



Fig. 63:  
Fossil-based value chain  
in the chemical and  
petrochemical industries

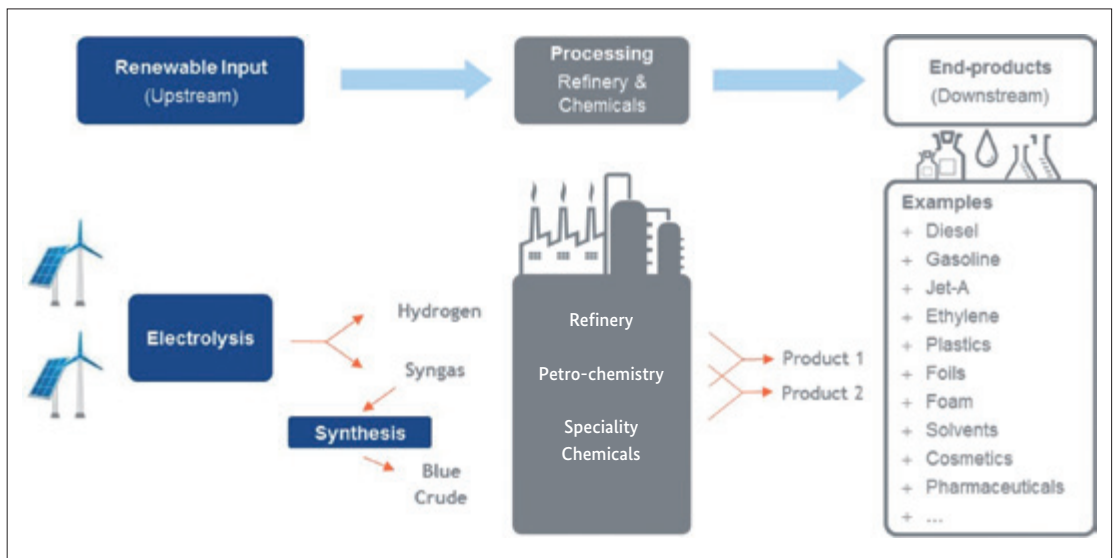
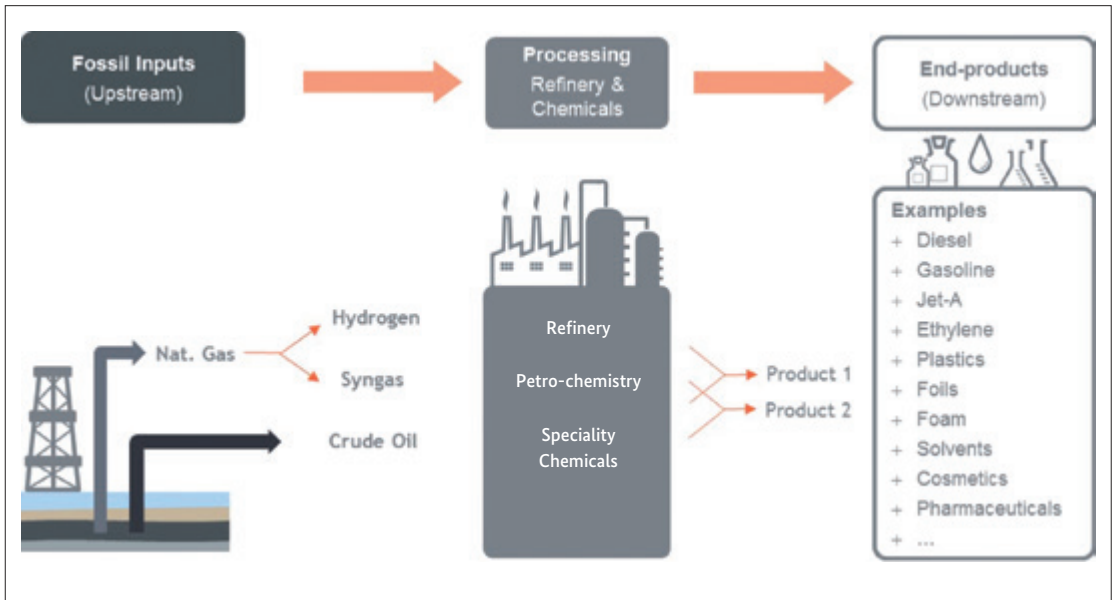

Fig. 64:  
Value chain in the chemical  
and petrochemical industries  
based on renewable sources  
of CO<sub>2</sub> and H<sub>2</sub>O

identical molecules that have been generated from CO<sub>2</sub>, water and renewable electricity.

The sunfire concept is no longer focused on supplying renewable end products, such as petrol or diesel, but on retaining and using the existing infrastructure of the petrochemical and chemical industries whose upstream molecular feedstocks are obtained from renewable sources. Examples of these new feedstock streams are:

- a) Hydrogen from fossil methane will be replaced by hydrogen from electrolyzers
- b) Synthesis gas (CO + H<sub>2</sub>) from fossil methane will be replaced by synthesis gas from electrolyzers, with downstream RWGS<sup>2</sup>, if required
- c) Fossil oil will be replaced by a substitute product generated from the Fischer-Tropsch reaction using synthesis gas made as described in Section 2 below.
- d) Pathways for the production of other basic chemical building blocks, such as methanol, formic acid etc. will also be implementable.

Storing energy in order to be able to convert it back into electricity is still relevant, but now of secondary importance. The continued addition of new electric power generating capacity from renewable sources and increasing load flexibility are helping to ensure that base load requirements can be met, with the result that the need to draw power from power storage systems is becoming increasingly rare.

The following two figures provide a comparison of the fossil-based and the renewables-based value chains for the chemical and petrochemical industries.

At the beginning of the project, the steam electrolysis stage and the electrically heated reverse water-gas shift reaction could be carried out at the lab scale (Technology Readiness Level 3).

## 2.2.2 Project description

The main goal of the project was to construct and operate a power-to-liquid plant based on the sunfire process. Prior to this, work packages had been

---

<sup>2</sup> RWGS = Reverse water-gas shift reaction for reducing CO<sub>2</sub> to CO. Can be substituted by the co-electrolysis of CO<sub>2</sub> and H<sub>2</sub>O.

Fig. 64:  
Power-to-liquid process

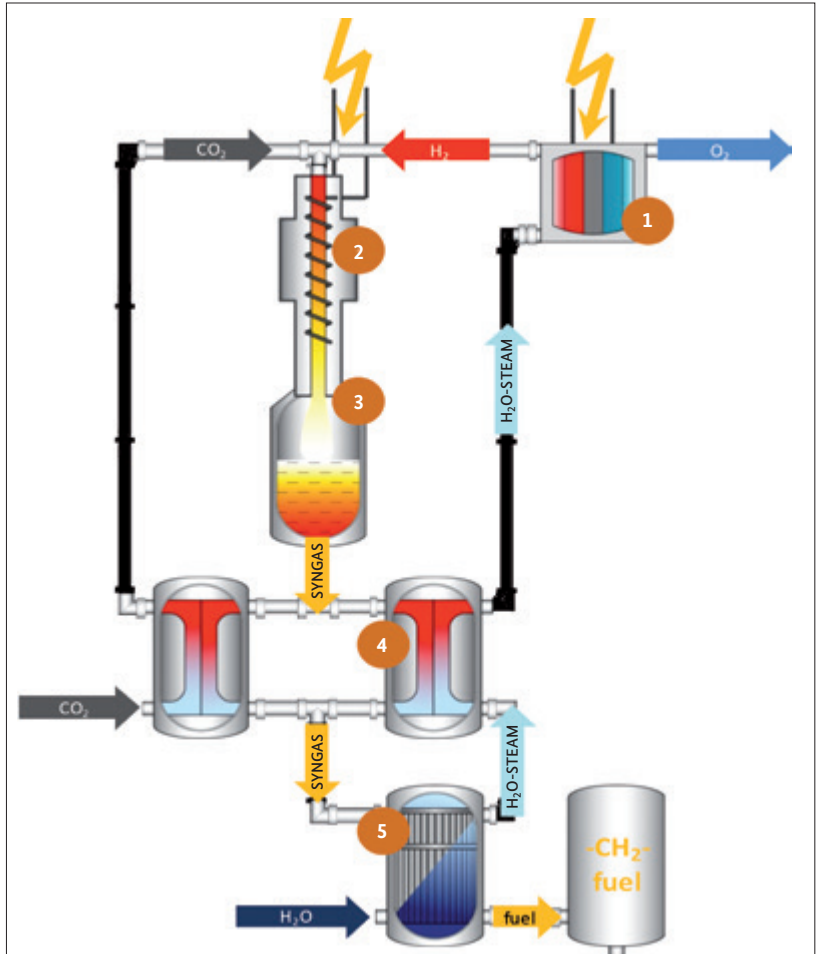

1. In the HTE stage, electrical energy is used to generate H<sub>2</sub> from steam:  
$$\text{H}_2\text{O} \Rightarrow \text{H}_2 + 0.5 \text{O}_2$$
2. CO<sub>2</sub> and H<sub>2</sub> are mixed in a ratio of 1:3 and then heated to a temperature of approximately 1000 °C by an electrical heater:  
$$\text{CO}_2 + 3 \text{H}_2$$
3. In the conversion reactor, the mildly endothermic reverse water-gas shift reaction reduces CO<sub>2</sub> on a nickel catalyst to CO (synthesis gas):  
$$\text{CO}_2 + 3 \text{H}_2 \Rightarrow \text{CO} + 2 \text{H}_2 + \text{H}_2\text{O}$$
4. The hot syngas from the conversion reactor enters the recuperators where in a counter-flow configuration it cools by pre-heating fresh CO<sub>2</sub> and steam.
5. The cooled syngas then undergoes a catalysed exothermic reaction in the synthesis reactor at a temperature of between about 200–300 °C (depending on the synthesis being carried out) to produce a liquid fuel:  
$$\text{CO} + 2 \text{H}_2 + \text{H}_2\text{O} \Rightarrow \text{-CH}_2\text{-} + 2 \text{H}_2\text{O}$$

The energy released during the synthesis stage is used to vaporise fresh water in the steam-cooled synthesis reactor. The steam is then superheated (see step 4) for use in electrolysis.

carried out to develop the two innovative components ‘High-temperature steam electrolysis (HTE)’ and ‘Reverse water-gas shift reactor (RWGS)’. At the same time, a life cycle assessment of the well-to-tank value chain was also compiled.

The sunfire power-to-liquid process is explained in figure 64.

The most important work carried out during the project is described in more detail below:

**a) Developing and testing the high-temperature steam electrolysis system (EIFER, Kerafol, sunfire, Fraunhofer ICT)**

Testing was conducted on cells, stacks and a pressure-driven system. Key areas included improving the electrodes of existing solid oxide fuel cells (SOFCs) to minimise electrode degradation so that they could also be used for electrolysis. Important milestones were the operation of a pressurised 10 kW HTE system for 200 hours and running a single cell for 20,000 hours. Additional tests were also carried out on cells and stacks operating in reversible mode (rSOC) and co-electrolysis mode.<sup>3</sup>

**b) Development of the synthesis gas generation stage using RWGS (Bayreuth University, sunfire)**

The first stage involved the comprehensive characterisation of the reverse water-gas shift reaction in the lab. This was followed by the design and testing of the first reactor (RWGS 1.0). The results from the RWGS 1.0 test runs enabled a range of improvements to be identified (see below) leading to the reactor design RWGS 2.0. The behaviour and performance of the RWGS 2.0 reactor will be studied in a follow-up project.

While the RWGS characterisation work was ongoing, a number of different Fischer-Tropsch catalysts were being tested. As Fischer-Tropsch synthesis is a mature technology (high TRL), the catalyst studies were predominantly of scientific relevance.

**c) Construction and operation of an industrial demonstration plant**

An industrial-scale plant (‘Fuel 1’) based on the process illustrated in Figure 64 was erected at sunfire’s Dresden site. For logistical reasons, the capacity of the plant was restricted to one barrel (159 litres) per day. To take account of the fact that the TRL of the HTE was relatively low at the beginning of the project, the rated power of the HTE was restricted to 10 kW so that additional hydrogen was fed in from a separate tank. The

---

<sup>3</sup> A number of the tests were not conducted within the project, but are mentioned here as they were carried out at the same time.

plant was officially opened in November 2014 by the Federal Minister for Education and Research, Prof. Johanna Wanka. In April 2014, the minister's official car was filled with sunfire diesel. Since then, the plant has been set to a range of different operating points and the findings used for process optimisation.

d) Compilation of a life cycle assessment and further project-related measures

In addition to the technical development work and operational demonstrations, a number of other project-related measures were carried out during the project period. Stuttgart University compiled a life cycle assessment of the PtL value chain. Working in collaboration with Lufthansa, Audi AG and HGM Energy GmbH, the fuel utilisation pathways were identified and de-

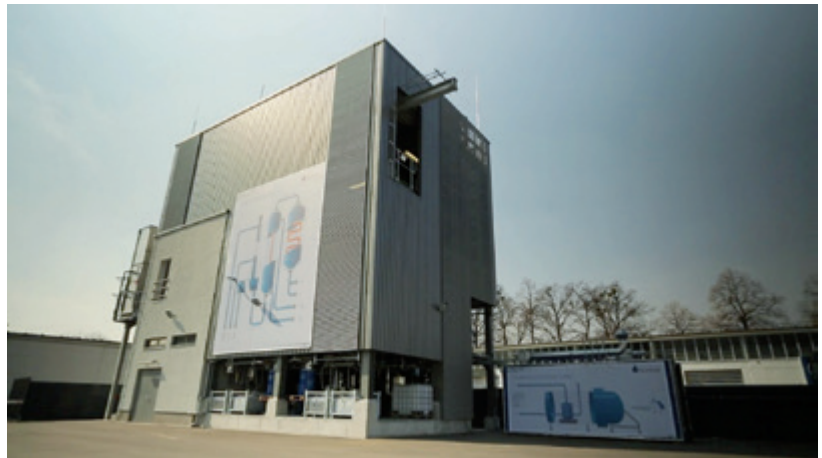

Fig. 65:  
The Fuel 1 plant



Fig. 66:  
The Federal Minister for  
Education and Research,  
Prof. Johanna Wanka,  
fills her ministerial car  
with sunfire diesel

scribed. Business models for PtL products were developed in cooperation with GETEC. A number of different technology scaling exercises were simulated at sunfire GmbH.

### 2.2.3 Results

The most important results from the project work described above will be presented in this section:

- a) The high-temperature electrolysis system was developed and improved, raising its TRL from 2 to 5. The technology has passed the lab-scale phase and is currently undergoing further development and practical test applications in order to produce an industrially viable solution.

Besides the one-dimensional electrolysis of steam to hydrogen, the HTE system was developed into a reversible fuel cell/electrolysis unit. This latter developmental stage was carried out principally for economic reasons as explained in the section on commercial exploitation below. The first 120 kW module was supplied to the US aeronautics company Boeing in 2015.

The validation of the fundamental feasibility of the lab-scale co-electrolysis system, which took place at the same time, is also of considerable economic relevance as it integrates the RWGS function, making production of synthesis gas more energy efficient and more cost-effective.

- b) The TRL of the production of synthesis gas by means of the RWGS reaction was raised from level 1 to level 4. If the ongoing development of the RWGS system is successful, the resulting technology will have a TRL 6 rating.

The main elements of the transition from RWGS 1.0 to RWGS 2.0 are:

- a concept for high-temperature insulation under pressure
- feeding in electrical energy for heating under pressure and at temperatures above 1000 °C
- preventing the formation of soot when the synthesis gas is cooled down from about 1000 °C.

All three issues are of major relevance not only for the continued development and improvement of high-temperature electrolysis, but for a wide range of other high-temperature industrial processes.

- c) The main technical results gained from operating the Fuel 1 plant are: proof that high-quality synthesis gas can be produced from CO<sub>2</sub> and hydrogen; and flexibility in the output of the overall process depending on the available energy supply. In addition to offering a sustainable production of hydrocarbons, the new technology can make a significant contribution to the operating reserve available for stabilising the electrical grid.

When implemented at an industrial scale, the overall process efficiency is about 60% for liquid hydrocarbons (power-to-liquid process) and about 70% methane (power-to-gas process).

Of no less significance than the technical results obtained from operating the Fuel 1 plant was the work done in presenting and communicating the technical feasibility of the overall process. The official opening of the plant and filling the tank of the ministerial car resulted in at least 500 media reports across all continents. The momentum generated has significantly advanced the discussion about the industrialisation of PtX technologies that utilise CO<sub>2</sub>.

- d) The life cycle assessment carried out by researchers at Stuttgart University demonstrated that, depending on where the renewable electricity was sourced, a reduction in carbon emissions of more than 85% was achievable using sunfire Blue Crude compared to a conventional fossil-based fuel.

## 2.2.4 Exploitation, commercialisation and dissemination of results

The main commercialisation pathways will be described in the section:

- a) The high-temperature steam electrolysis system is now being industrialised as a separate product. A number of modules with power ratings in the triple-digit kilowatt range are currently being built. The goal is to complete the development and validation of the technology for industrial applications for the purposes of the inter-sector coupling described in Section 1 above. The reversible mode option is of particular importance. One-dimensional hydrogen generators or PtX plants produce fewer full-load hours per year than reversible plants, which can be used to provide electric power and heat from hydrogen or natural gas in periods when electricity prices are high. Reversible plants therefore make economic sense.

The first issue that needs to be addressed when commercialising the electrolysis system is the production of hydrogen. The first applications of this technology are being used to supply small consumers whose hydro-

gen requirements can be met more cheaply by a local dedicated electrolysis unit than by an expensive hydrogen logistics network. Larger facilities, such as refineries, are also conceivable provided that the necessary statutory framework is in place.

In future developments, co-electrolysis will also be used for the direct production of synthesis gas. The first applications of this technology will be demonstration units probably operated in cooperation with companies in the chemical sector. Further work in this area is planned as part of the government-funded Kopernikus scheme.

- b) PtX technology will be offered in its entirety, with sunfire GmbH concentrating on the production of synthesis gas. The chemical synthesis technologies (Fischer-Tropsch, methanol synthesis, Sabatier process) will be provided by partners. Discussions are currently being held with numerous potential customers and operators. Major obstacles on the path to establishing a first industrial-scale technology demonstrator are the continuing high costs and the regulatory framework (see below).
- c) The RWGS 2.0 reactor has yielded some important findings relating to high-temperature insulation and high-temperature heating under pressure and energy efficient means of avoiding soot production when cooling synthesis gas. In addition to their application in renewable synthesis gas technology, these findings can also be used beneficially in the production of synthesis gas from fossil-based natural gas. Sunfire will be commercially exploiting these findings in other sectors.
- d) The concept of inter-sector coupling described above and the technical progress made during the sunfire project have been communicated regularly at specialist meetings and conferences. sunfire GmbH is working with numerous partners from industry and from public bodies to establish a sustainable concept for the economically viable introduction of PtX technology. This collaborative interaction is designed not only to continue technology development but also to address issues relating to the essential regulatory framework. Only when sustainably produced chemicals and fuels are able to compete fairly against fossil-based products will there be any meaningful chance of them transitioning from the development and technology demonstration stage towards large-volume industrial-scale applications.



## 2.3 CO<sub>2</sub>RRECT – Utilisation of CO<sub>2</sub> as a carbon building block using predominantly renewable sources of energy

BMBF Project FKZ 033RC1006

Project Coordinator: Dr. Stefanie Eiden, COVESTRO

Project Partner: RWE, Siemens, COVESTRO, Bayer, Cat Catalytic Center, RWTH Aachen, TU Darmstadt, KIT, LIKAT, invite, TU Dortmund, TU Dresden, Universität Stuttgart, Ruhr Universität Bochum

### 2.3.1 Introduction

The CO<sub>2</sub>RRECT project was concerned with the production of high-grade chemical products by reacting CO<sub>2</sub> with hydrogen generated using renewable sources of energy. A research consortium comprising Bayer, RWE, Siemens and ten academic partners worked together on this new concept.

While output from conventional power plants is demand-driven, electricity produced from renewable sources of energy, such as wind and solar power, fluctuates as weather conditions change. As many countries, including those in the European Union, want to significantly expand the amount of electricity produced from renewable sources, electricity storage systems offer a means of balancing electricity supply and demand.

If CO<sub>2</sub> is to be used as a material resource or chemical feedstock in a way that is both cost-efficient and environmentally sustainable, then fluctuations in the energy supply from renewable sources are unavoidable, but are also a potentially attractive proposition for the chemical industry. Up until now, chemical production has been designed and optimised on the understanding that energy supplies are constant. In a renewables-based energy system, new models will need to be developed to describe how the power sector and the chemical industry will interact in future. On the electricity production side there will be a need for both material and electricity storage systems. On the chemical production side there is a strong drive towards achieving energy-efficient production processes that are both modular and flexible.

If this concept is to be implemented effectively, there will be a need to mesh certain aspects from the power generation sector with others from the chemical industry. For the purposes of this project, it was important to gain an understanding of the overall process: from the generation, distribution and supply of energy through to the final chemical product. A general over-

view of how CO<sub>2</sub> could be utilised in the chemical industry was therefore compiled covering both process and plant engineering aspects. The potential to reduce carbon emissions and to use CO<sub>2</sub> as a chemical feedstock was systematically evaluated.

Using renewable energy to heat a reactor can also help to optimise the overall energy balance of a chemical production process. The reaction technologies currently used (catalysts and reactors) were designed and configured for stationary petrochemical production facilities and are therefore less suitable for the type of flexible decentralised production that would be needed in order to accommodate the fluctuations associated with electricity from renewable energy sources. As a result, the project not only had to find answers to the typical questions relating to catalytic reaction technology (activity, service life, deactivation, costs, etc.), but also had to address the core issue of developing a modular flexible reaction technology.

### 2.3.2 Project description

The aim of the CO<sub>2</sub>RRECT project was to develop technically mature conversion technologies that would facilitate the chemical conversion of fossil-based CO<sub>2</sub> using renewable H<sub>2</sub> and/or renewable energy. The key areas of focus were:

- the reverse water gas shift reaction (RWGS) to form CO,
- dry reforming using renewable energy and/or methane from CO<sub>2</sub> methanation to produce synthesis gas
- hydrogenation of fossil-based CO<sub>2</sub> to form formic acid.

Fig. 67:  
CO<sub>2</sub> can be utilised as a raw material for the chemical industry by reacting it with hydrogen from renewable sources of energy to convert it into useful chemical products (photo: Bayer)

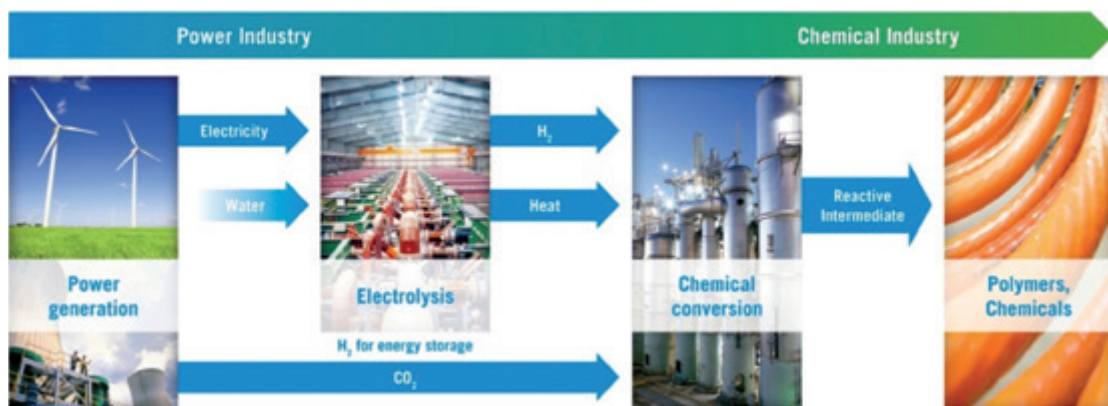

To help achieve project objectives quickly and efficiently, a number of work packages were defined that were carried out in accordance with an agreed project plan. Project progress was monitored by means of project milestones and decision points.

In order to implement and evaluate the overall concept, a number of **preparatory and post-processing steps** were necessary:

- Supply of CO<sub>2</sub> from the flue gas stream of a coal-fired power plant and at a purity level suitable for the proposed reforming reaction. In order for the C1 building block CO<sub>2</sub> to be used as a chemical feedstock, the gas must be practically free from any **catalyst poisons**. The goal was to determine whether the captured CO<sub>2</sub> could be used without further processing or whether additional purification stages were required.
- The hydrogen needed to chemically activate the CO<sub>2</sub> is generated by electrolysis. The electrolytic process was powered using excess electricity resulting from fluctuations in the electric power being fed into the grid from renewable sources of energy. The challenge was to develop an electrolysis unit that was capable of being operated by a dynamically fluctuating power source.
- A method of **hydrogen storage** forms the link between the temporary generation of H<sub>2</sub> in the electrolysis unit and the continuous use of H<sub>2</sub> in the chemical conversion of CO<sub>2</sub>. One of the questions that needed to be addressed was what kind of hydrogen storage system would offer sufficient storage capacity and the requisite accessibility while also being technically and economically feasible to implement.
- The subsequent utilisation of the product from the CO<sub>2</sub> reforming reaction is an important aspect as it determines whether any downstream workup and separation has to be performed. The different possible utilisation routes for the product of the reforming reaction were therefore also taken into consideration. The downstream process studied in the project was the **polymer manufacturing route** for producing polyurethanes and polycarbonates from CO.
- To obtain a reliable scientifically-based evaluation of the different alternatives it was essential that the different variants were assessed in their entirety using an appropriate and unbiased methodology. This required access to validated sets of data, which for many of the options under discussion were not available and therefore had to be compiled, and it required extending or adapting the **life cycle assessment (LCA)** methods. To ensure that the assessments could be legitimately compared, the sys-

tem boundaries for the various technological options had to be specified precisely.

The **project objectives** to be achieved were:

### **Overall process**

- Optimise the design and dimensioning of the components used in the overall process
- Derive the dynamic load profiles that the electrolysis process will be subjected to
- Compile LCAs and energy balance analyses
- Compile a technical requirements document for the pilot plant

### **Starting materials for the CO<sub>2</sub> conversion process**

- Monitor the quality of the fossil-based CO<sub>2</sub> to be used in the planned chemical conversion
- Use the PEM electrolysis unit as a dynamic load-following unit to generate renewable hydrogen
- Scale-up of electrolysis process to a power rating of 100 kW
- Test concept for incorporating waste heat from the electrolysis unit into the integrated chemical production facility to improve overall efficiency
- Development of storage concepts

### **CO<sub>2</sub> conversion**

- Develop catalytic systems for the CO<sub>2</sub> reforming and the RWGS reactions that will remain active over sustained periods
- Innovative hybrid-heated reactor
- Develop catalyst for the hydrogenation of CO<sub>2</sub> to formic acid

### **Interfacing with existing value chains**

- Quality assurance of CO and preparation of gas for conversion of CO to polymers

### **Technology demonstration at lab and pilot plant scales**

- Construct an autonomous high-pressure electrolysis system (e.g. 50 bar) with a power rating of 100 kW; test under the simulated dynamic load requirements
- Connect electrolysis unit and CO<sub>2</sub> conversion unit (reforming and RWGS reactions) using a modular lab-scale set-up; include add-on hydrogen storage system to determine the effect of fluctuating power generation from renewable energy sources on the overall system.

The overall concept represents an outstanding example of how a chemical process (CO<sub>2</sub> conversion) and an electricity generating process (CO<sub>2</sub> capture

and supply, grid incorporation) can be combined to achieve the joint goals of effective CO<sub>2</sub> utilisation and climate protection.

### 2.3.3 Results

The project achieved all of its technological goals. For CO<sub>2</sub> to be chemically converted into synthesis gas under conditions of fluctuating power input, both the H<sub>2</sub> and CO<sub>2</sub> feedstock streams must be supplied in sufficient quantity and quality. A number of different transport and storage concepts

for hydrogen and CO<sub>2</sub> were therefore compared and assessed. Gas pipelines (CO<sub>2</sub>, H<sub>2</sub>) and storage systems (H<sub>2</sub>) are needed if feedstock supplies to a continuously operating production plant are to be guaranteed.

As planned, Siemens and RWE built an autonomous high-pressure water electrolysis system (e.g. 50 bar) for hydrogen production with a power rating of 100 kW and tested the system under the simulated dynamic load requirements. The electrolysis unit responded extremely rapidly and in accordance with Siemens' load-following specifications. The project also examined CO<sub>2</sub> utilisation schemes in which CO<sub>2</sub> was chemically converted to another C1 building block in processes powered by renewable energy. To achieve high production volumes, the reactions had to be run at high temperatures, which in turn required the development of an efficient catalyst that was thermally stable and that

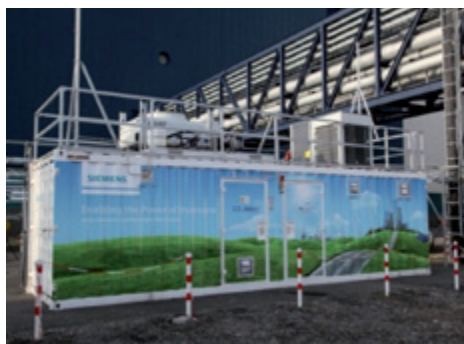

Fig. 68:  
Prototype of the Siemens  
electrolysis unit

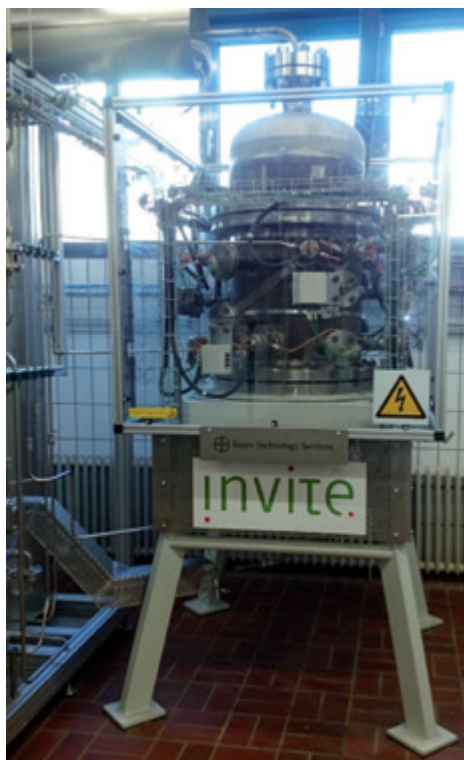

Fig. 69:  
Prototype of the  
reforming reactor

minimised soot formation. An appropriate catalyst was developed by the academic project partners (Universities of Aachen, Bochum, Dortmund, Dresden and Stuttgart, the Max Planck Society, the Leibniz Institute for Catalysis at the University of (LIKAT), the Karlsruhe Institute of Technology and the INVITE Research Centre). To reduce energy consumption a new heating concept was also needed and this was developed over the course of the project. The chemical reactor was then designed on the basis of these initial developments. A particularly important aspect of the reactor's design was thermal efficiency and the use of thermally stable materials. A demonstrator was built that incorporated the newly developed heating system. The results showed that the catalyst-loaded heating coils exhibited excellent activity in the reforming reaction and that a single coil was able to achieve conversion rates of 20–30%. The layer activities originally estimated were based on a layer thickness of 10 µm and a washcoat efficiency of 100%. It could be shown that a thicker layer yielded a sevenfold increase in catalytic activity. A production-scale reactor is therefore likely to operate effectively with a significantly smaller numbers of reaction stages.

One of the main project objectives was to evaluate the processes that had been developed under realistic operating scenarios (**BTS**). The base scenario selected was supplying a 400 ktpa MDI plant with H<sub>2</sub> and CO. The capital investment needed to implement the candidate technologies for producing carbon monoxide and hydrogen proved to be extraordinarily high. This was due to:

- the high specific costs of the water electrolysis process and
- the need to install an electrolysis unit with a very high power rating that will be able to exploit the temporary availability of excess electrical energy.

The payback period for such a large capital investment is correspondingly long and makes assumptions about the long-term pricing structures for electricity and natural gas.

**ITT in Aachen** evaluated environmental aspects of the technology such as the global warming potential (GWP) and fossil depletion potential (FDP). It could be shown that the CO<sub>2</sub>RRECT processes have the potential to reduce greenhouse gas emissions and to lower consumption of fossil resources relative to the standard benchmark. The maximum achievable reduction in greenhouse gas emissions associated with the production of 109.4 kt of synthesis gas and 161.2 GWh of electricity are about 200 kt CO<sub>2</sub> per year.

### 2.3.4 Exploitation, commercialisation and dissemination of results

The project has yielded a large number of patents and publications that have helped to raise the visibility of the project and its objectives. Some of the results have been presented in the form of talks and posters at scientific and technical conferences in Germany and abroad.

All of the project partners were able to extend and improve their competence and expertise in this field and gained important experience regarding the application of this type of technology in the field of chemical processes. The experience gained will be important for future potential projects in this area. The results generated by the project are also applicable to other endothermic heterogeneously catalysed processes that run at high temperatures and require energy-efficient heating. Scientific study of such processes will continue as one of the stated objectives of the 'Energy Efficiency, Materials and Resources' research programme (EMR). Another question that will be addressed is whether the reactor concept can be used for other reactions such as benzene production or as a replacement for rotary furnaces.

According to the project partners, the economic prospects for this type of process are slight, for the following reasons:

- Supplies of CO<sub>2</sub> with the necessary specifications cannot be guaranteed at present.
- The costs associated with generating hydrogen from the electrolysis of water (PEM) are still very high and there are currently no facilities available that could provide the industrial-level quantities required.

In view of the existing cost structures (generation of hydrogen from water electrolysis and CO<sub>2</sub> costs), the technology cannot currently compete with existing steam methane reforming processes. From the perspective of the industrial project partners, price developments for balancing energy and for renewable energy mean that there is little possibility of implementing the technology as things stand at present. Price developments will, however, be monitored critically as the energy transition proceeds and in the event of positive developments the feasibility of the technology will be reassessed based on the scientific findings from the CO<sub>2</sub>RRECT project.



## 2.4 SEE – Storage of electrical energy from renewable resources in the natural gas grid

BMBF Project FKZ 033RC1010

Project Coordinator: Frank Graf, Felix Ortloff; DVGW-Forschungsstelle am Engler-Bunte-Institut des Karlsruher Instituts für Technologie (KIT)

Project Partner: DVGW-Forschungsstelle am Engler-Bunte-Institut des Karlsruher Instituts für Technologie (KIT) (DVGW-EBI), Fraunhofer-Institut für Solare Energiesysteme (ISE), Engler-Bunte-Institut, Karlsruher Institut für Technologie (KIT-EBI), Energie Baden-Württemberg AG (EnBW), H-TEC SYSTEMS GmbH (H-TEC), IoLiTec Ionic Liquids Technologies GmbH (IoLiTec), Outotec GmbH

### 2.4.1 Introduction

The electrical energy generated by wind and solar power fluctuates significantly over time. As the amount of energy withdrawn from the grid must at all times balance the quantity of electricity being fed into the grid, the increasing use of renewable sources of energy is therefore driving the need for flexible solutions capable of storing and releasing large quantities of electrical energy. However, existing electricity storage options have insufficient capacity to meet the demand for medium-term to long-term storage of electrical energy.

Germany has an excellent natural gas storage and distribution infrastructure. The country's pore and cavern storage facilities for natural gas have a working gas volume of approximately 23 billion m<sup>3</sup>, which is equivalent to about 275 TWh<sub>chem</sub>. For the purposes of comparison, the energy storage capacity of pumped hydroelectric plants is about 0.04 TWh<sub>el</sub>. Additional storage facilities with a volume of 5 billion m<sup>3</sup> are currently under construction or at the planning stage. Even without taking the storage capacity of the natural gas grid into consideration, a storage capacity totalling around 330 TWh<sub>chem</sub> will then be available, which is roughly four times the total amount of electricity generated from wind power in 2015.

The **SEE research project 'Storage of electrical energy from renewable resources in the natural gas grid – H<sub>2</sub>O electrolysis and synthesis'**, which was funded by the German Federal Ministry of Education and Research (BMBF) and ran from January 2011 until June 2014, developed a concept for the chemical storage of the fluctuating levels of electricity generated by wind power and photovoltaic systems. This renewable electricity was used to synthesise substitute natural gas (SNG) from CO<sub>2</sub> that could be fed into the natural gas network.



The stored SNG could then be used in a range of industrial sectors whenever and wherever demand arose. For example, the gas could be used to power CHP units to regenerate electricity or it could be transferred to the industrial, chemical, heating or transport sectors where it could be used to reduce emissions of anthropogenic carbon.

### 2.4.2 Project description

The project examined the entire power-to-gas process chain, beginning with the fluctuating supply of excess electricity, the high-pressure electrolysis of water, CO<sub>2</sub> methanation via a novel 3-phase reactor concept, and adjustment of calorific value based on a Fischer-Tropsch synthesis involving H<sub>2</sub> and CO<sub>2</sub>.

The main focus was on process development and optimisation to accommodate the dynamic operation of the process chain.

It was also a project objective that raw materials for both the main and secondary processes would be supplied entirely from renewable sources.

A total of six work packages were defined in which all of the sub-processes were studied in detail and developed. Potential synergies between the individual process stages were identified and assessed from both a systems analysis and an economic perspective (see Fig. 70). The project consortium comprised three research institutions and four industrial partners. Overall project coordination was performed by the DVGW Research Centre at the Engler Bunte Institute in Karlsruhe.

Fig. 70:  
The SEE process chain  
indicating the six project  
work packages

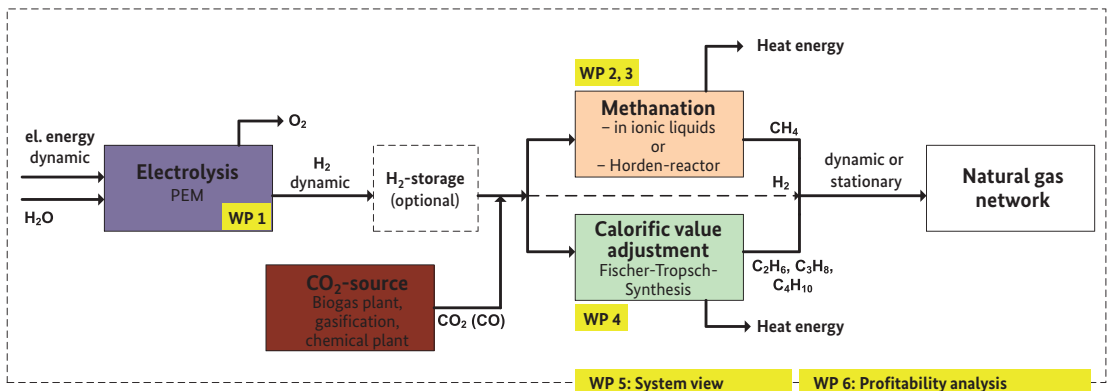

### 2.4.3 Project results

In **work package 1a** a polymer electrolyte membrane (PEM) electrolysis unit that operates at a system pressure of 30 bar was developed and optimised for the specific requirements of the power-to-gas process chain. The benefit of high-pressure water electrolysis is that the hydrogen is generated under pressure and therefore does not need to undergo any energy-intensive compression stage before it can be used in the subsequent process steps. At the core of the electrolysis unit is a polymer electrolyte membrane (PEM) – a gas-impermeable membrane coated with a catalyst that enables hydrogen to be generated with high efficiency. The membrane's polymer framework is permeable for H<sup>+</sup> ions and this proton exchange membrane therefore functions as a solid electrolyte that conducts electricity. Work within WP 1a focused mainly on stack optimisation by integrating alternative materials that could potentially optimise efficiency, service life, pressure and cost of the electrolysis unit.

**Work package 1b** is closely related to work package 1a. Building on the hardware developments in WP 1a, WP 1b focused on integrating the electrolysis subsystem into the overall system. The individual hardware components were modified and optimised so that the electrolysis unit was able to draw electric power from renewable sources (wind and solar) while also supplying hydrogen to the methanation stage. The electrolysis unit itself was also improved to meet the differing dynamic requirements of the upstream and downstream subsystems.

The hydrogen generated in the electrolysis unit was then reacted with CO<sub>2</sub> to form methane, the main component of natural gas. In **work package 2a** a promising alternative reactor design, known as a 'slurry' reactor was developed. In a slurry reactor, the reaction occurs on a solid catalyst that is present as finely divided particles suspended in a fluid medium. In this type of reactor the heat generated by the reaction can be efficiently dissipated by the fluid. Because the fluid has a high heat capacity, this type of three-phase system is well suited for the dynamically variable operation of the methanation reaction.

Following a comprehensive literature search regarding the temperature stability of ionic liquids (ILs) and after examining the thermal stability of ILs already available from IoLiTec as well as newly synthesised ILs, a set of new structural elements and additives were developed that enabled the temperature stability of ionic liquids to be improved (**work package 3**). In addition to the synthesis and additivisation of ionic liquids, the physical properties of the newly synthesised ionic liquids and the additivated ionic liquids were determined.

As an alternative to the slurry reactor, a fixed bed methanation process in a multistage reactor was developed in **work package 2b**, which included examining the cost-effectiveness of small and medium-sized reactors of this type. A new test set-up was designed, built and commissioned in order to test the suitability of the various candidate catalysts for the dynamic operation of the CO<sub>2</sub> methanation process.

Previously, the caloric value of the SNG was adjusted using a fossil-based liquid gas. To make the process chain independent of fossil fuels, the objective of **work package 4** was to develop a modified Fischer-Tropsch synthesis that could use the renewably generated H<sub>2</sub>/CO<sub>2</sub> feedstock to produce C<sub>2</sub>-C<sub>4</sub> hydrocarbons. Besides carrying out experimental investigations, the process was also modelled mathematically. By calculating various case studies, data was generated that assisted one of the objectives in **work package 5**, which was to study the dynamics of the overall system. WP 5 also examined the integration of material and energy streams into the overall process. Additional activities involved assessing and estimating the social impact and the greenhouse gas reduction potential of the power-to-gas process.

Using the results from the other work packages, **work package 6** analysed the economic potential of the new technology for the electricity sector. The analysis took particular account of the potential offered by the growing quantities of fluctuating electricity generated from renewable sources such as onshore and offshore wind farms and photovoltaic facilities. The impact of economic conditions and the regulatory framework on the long-term opportunities for this new technology were assessed up to the 2030 time horizon.

## 2.4.4 Exploitation, commercialisation and dissemination of results

A number of different channels were used to disseminate the results during and after conclusion of the research project.

As the research teams involved in the project have had longstanding links to universities, many of the project findings were soon incorporated into academic study programmes. The results from the project led to new research goals and new research projects and collaborations being identified and to the recruitment of scientific personnel to address these new research questions.

While the project was ongoing, the results were communicated to the wider public via the websites of the project partners. To communicate information

effectively to companies and experts working in the field, the project teams made use of the following channels: newsletters, presentations of the (interim) results at national and international conferences, trade fairs (e.g. the gas industry meeting GAT) and publications in scientific journals. A number of selected publications are listed below:

- Götz, M. et al.: Renewable Power-to-Gas: A technological and economic review. *J. Ren. Energy*, 85 (2016), 1371-1390
- Lefebvre, J. et al.: Improvement of three-phase methanation reactor performance for steady-state and transient operation. *Fuel Processing Technology*, 132 (2015), 83-90
- Götz, M. et al.: Long-term thermal stability of selected ionic liquids in nitrogen and hydrogen atmosphere. *Thermochimica Acta*, 600 (2015), 82-88
- Götz, M. et al.: Einsatz eines Blasensäulenreaktors zur Methansynthese, *Chemie Ingenieur Technik* 85 (2013) 7, 1-7
- Schaaf, T. et al.: Speicherung von elektrischer Energie im Erdgasnetz – Methanisierung von CO<sub>2</sub>-haltigen Gasen, *Chemie Ingenieur Technik, Sonderausgabe Reaktionstechnik* 2014, 86 (2014), 4, 476-485
- Iglesias G. M. et al.: Chemical Energy Storage in Gaseous Hydrocarbons via Iron Fischer-Tropsch Synthesis from H<sub>2</sub>/CO<sub>2</sub> – Kinetics, Selectivity and Process Considerations, *Catalysis Today*, 242 (2014), 184-192

Work on many of the questions addressed during the SEE project continued after the project had ended. For example, significant effort was put into scaling up the CO<sub>2</sub> methanation process. Planning work is also currently underway for a demonstration plant as part of the KIT project EnergyLab 2.0 ([https://www.kit.edu/kit/pi\\_2014\\_15859.php](https://www.kit.edu/kit/pi_2014_15859.php)). The results are also being exploited commercially by the industrial project partners. Companies that manufacture electrolysis units for use in the power-to-gas process chain have continued to optimise their equipment in order to be able to meet the challenges that will continue to be posed as Germany transitions to a fully renewables-based energy system.

# 2.5 iC<sup>4</sup>: integrated Carbon Capture, Conversion and Cycling

An approach to achieving CO<sub>2</sub>-based energy storage

BMBF Project FKZ 033RC1106

Project Coordinator: Prof. Bernhard Rieger, Technische Universität München  
 Project Partner: MAN Diesel & Turbo SE, Wacker Chemie AG, Fraunhofer-Gesellschaft zur Förderung der angewandten Forschung e.V., Linde Aktiengesellschaft, Siemens Aktiengesellschaft, Clariant Produkte (Deutschland) GmbH, E.ON New Build & Technology GmbH

## 2.5.1 Introduction

The iC<sup>4</sup> concept is an **integrated approach to achieving CO<sub>2</sub>-based emissions-neutral energy storage. A sustainable CO<sub>2</sub> management strategy** builds on the three elements of carbon avoidance, carbon capture and carbon utilisation, all of which are addressed in the iC<sup>4</sup> approach.

A key feature of the strategy behind the iC<sup>4</sup> collaborative project is that in addition to offering more energy-efficient technologies for reducing CO<sub>2</sub> emissions and for capturing CO<sub>2</sub>, it also aims to make use of **large quantities**

Fig. 71: CO<sub>2</sub>-“circulation”

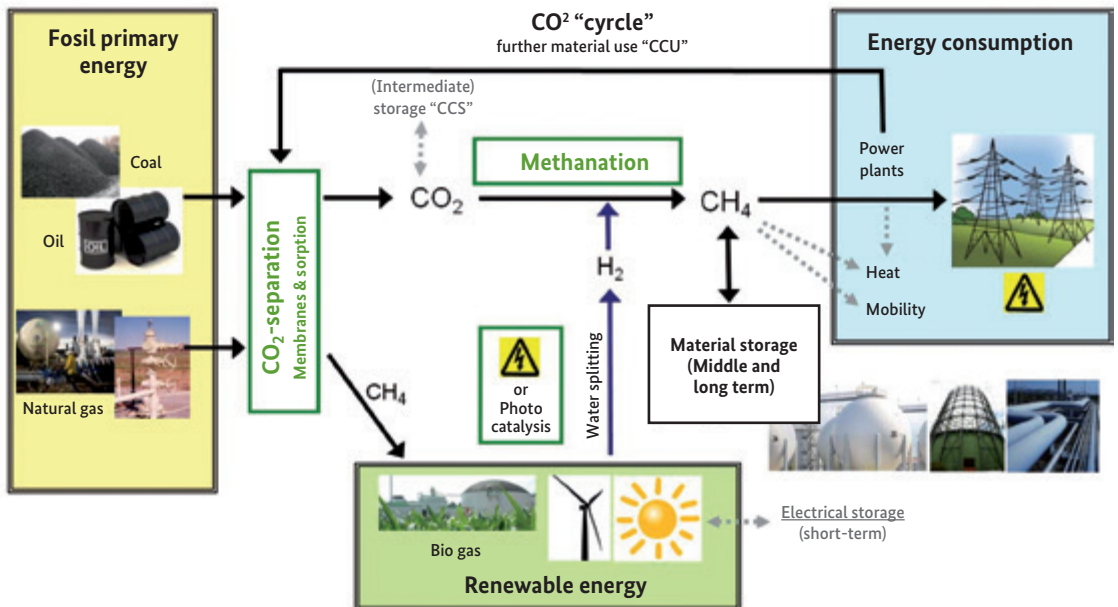

**of the harmful greenhouse gas CO<sub>2</sub> as a raw material** for energy storage systems and as a source of carbon for the basic chemicals used in chemical production processes. The approach adopted is therefore to use **CO<sub>2</sub> as an energy storage vector**. By **chemically reducing CO<sub>2</sub> to methane**, CO<sub>2</sub> emission levels can be reduced significantly and the resulting product 'synthetic natural gas' (SNG) can be fed into the **existing infrastructure** for energy storage, distribution and use. The reduction process will, wherever possible, use hydrogen generated from renewable sources of energy. At present, the hydrogen generating systems are driven by otherwise unused peak electric power (from wind turbines) and by the surplus electric power arising from unmatched production and consumption levels (photovoltaic systems and conventional power plants).

{This approach has the potential to sustainably reduce CO<sub>2</sub> emissions, as the carbon serves as a continuously recyclable store for energy generated from renewable sources. If large volumes of CO<sub>2</sub> are to be reintroduced into the chemical production cycle, an efficient carbon capture technology needs to be developed. This aspect was addressed in the subprojects 'iC<sup>4</sup>: COOMem' (separation of CO<sub>2</sub> using membrane technology) and 'iC<sup>4</sup>: AdCOO' (separation of CO<sub>2</sub> using solid sorbents). The conversion of CO<sub>2</sub> to methane was the subject of the 'iC<sup>4</sup>: COOMeth' subproject in which the partners TUM, EON, WACKER, Südchemie, MAN and Linde collaborated closely and where the expertise from the two chemical companies could be exploited for the development of new catalysts. In addition to making use of excess electrical energy from renewable energy sources, novel ground-breaking concepts needed to be developed if the project goals were to be achieved. The subproject 'iC<sup>4</sup>: PhotoCOO' examined direct and indirect uses of solar power, drawing on new concepts in photocatalysis including the integrated photocatalytic activation of CO<sub>2</sub> and H<sub>2</sub>O to produce basic chemical building blocks used in the chemical industry.

## 2.5.2 Project description and results

The goal of the **AdCOO** subproject was to develop novel CO<sub>2</sub> separation technologies based on solid sorbents that could be used both for conventional coal-fired power plants (post-combustion capture) and next-generation power plants (pre-combustion capture) and that would require significantly less energy than the wet scrubbing techniques currently used (post-combustion: typically using reactive amines; pre-combustion: using methanol or polyethylene glycol at low temperatures).

Parallel studies were also carried out that were aimed at reducing energy consumption in aqueous systems by exploiting specific entropic effects as-

sociated with suitable polymers. LCST (lower critical solution temperature) polymer solutions exhibit entropically driven demixing at temperatures above the LCST with the result that the polymers separate from the aqueous phase. At temperatures below the LCST, the polymer is completely miscible in the aqueous phase. If these polymers have suitable substituents, the LCST effect can be exploited to influence the pH of the aqueous solution. A lower pH promotes the release of CO<sub>2</sub> from the hydrogen carbonate ion HCO<sub>3</sub><sup>-</sup>, which forms when CO<sub>2</sub> is absorbed in the aqueous solutions of amines typically used in post-combustion carbon capture. However, the reduction in the amount of heat necessary to release the dissolved CO<sub>2</sub> is too small to enable a new more energy-efficient technology to be developed.

In the area of post-combustion carbon capture, fundamental insights into the reaction mechanisms underlying the CO<sub>2</sub> capture process were made regarding:

- a) the use of various amine reagents, both in aqueous solution and immobilised on solid support materials, and
- b) a variety of zeolite systems.

The economic feasibility of their use in a range of different technical processes was assessed.

The study carried out in collaboration with the project partner Siemens into the technical and economic feasibility of carbon capture technology based on the use of solid sorbents showed that optimising heat integration, which would allow the heat generated during the exothermic absorption stage to be used for the endothermic desorption step, was considerably more complex than originally thought and would require increased capital investment costs that would outweigh the economic benefits of reduced running costs. Heat integration for wet scrubbing systems is considerably easier to implement. In summary, solid solvents are better suited for pre-combustion applications in which the CO<sub>2</sub> is generated at high partial pressures and thus a thermodynamic driving force is already present in the system that can be used in the subsequent CO<sub>2</sub> desorption/sorbent recovery stage. The cage concept based on spherical silica particles developed by Professor Lercher's group at TUM may well be suitable for this approach.

In the **COOMem** subproject, novel coatings were developed and applied to asymmetric silicon matrices to yield new membranes that are able to separate CO<sub>2</sub> with surprisingly high selectivity from a variety of different gas streams. Initial attempts by Fraunhofer research teams to develop hollow-fibre membranes proved successful and the first modules consisting



of membrane bundles have now undergone testing at Linde. The materials demonstrated a reversible CO<sub>2</sub> absorption capacity previously unattained for polymer-based systems and could be processed to yield defect-free homogeneous films. The thin polyelectrolyte films on TPSE support membranes exhibited highly competitive CO<sub>2</sub> flow rates and ideal CO<sub>2</sub>/N<sub>2</sub> selectivity values of up to 67.7. In order to achieve a more tightly packed, selective membrane material attempts were made to achieve the stereoregular polymerisation of 4-vinyl phenol. However, it was not possible to achieve any significant stereoregularity within the polymer chain even under the mildest reaction conditions. Characterisation of the membrane technology under realistic operational conditions (mixed gases and presence of water vapour), ideally under permanent loading and with the system in its steady state, was accomplished while the membrane module (Fraunhofer IGB) and the pilot plant (Linde AG) were under construction.

The **COOMeth** subproject was central to the collaborative research project iC<sup>4</sup> and was concerned with developing high-efficiency catalysts as well as a hydrogenation strategy that was compatible with the overall process. Both of these objectives were met. At the end of the subproject, the team had developed a catalytic process with optimised catalysts and a customised reactor that enables the continuous conversion of CO<sub>2</sub> to methane with yields of over 96% and that is characterised by simple reactor throughput, high selectivity and a long service life.

One of the achievements of the subproject was the development of efficient nickel catalysts for the methanation of carbon dioxide that exhibited high thermal stability and good resistance to high concentrations of water vapour. The properties of more than 500 candidate catalysts were examined under realistic conditions; the catalysts were tested with the aid of a parallel reactor system operated by WACKER Chemie AG. The experiments were planned and evaluated using concepts from DOE (design of experiments) methodology and multivariate data analysis.

The nickel-supported catalysts fabricated using a variety of impregnation methods showed only moderate activity in the Sabatier (methanation) reaction. However, the experimental data indicates that by optimising the calcination process, catalysts of satisfactory activity with moderate metal loading can be produced. The addition of small amounts of promoters can significantly increase the activity of the nickel catalysts. Certain promoters also help to increase the stability of the catalyst in the harsh reaction conditions that arise in large-scale industrial applications. The promoter-doped fully impregnated nickel catalysts achieved the maximum possible conversion of CO<sub>2</sub> at the relatively low temperature of 250 °C and a GHSV of 35,000 h<sup>-1</sup>. The methane yield with these systems was always above 95%.

Cobalt supported catalysts exhibited catalytic properties similar to their nickel-based counterparts. The decision was therefore made to carry out comparative screening of the promoters used for both systems. The results showed that the promoting effects were similar for the two metals studied. Metal additives that lower the methane selectivity in favour of increased CO production always resulted in a reduction of activity compared with the unpromoted reference system.

The **PhotoCOO** subproject was concerned with the elementary steps involved in the aqueous reduction of CO<sub>2</sub>. In the case of the homogeneous catalysts, the research teams acquired a deeper understanding of the low turnover numbers caused by light-induced decomposition. A completely new photoreactor system using LED arrays was developed that provided light energy only for the required reaction channels. This work has identified an area with enormous development potential for new photostable catalysts as well as for new reactor systems.

The goal of the team working at the Department of Chemical Technology II (TUM) was to develop a solar-powered single-stage route to C1 chemical building blocks and energy carriers from carbon dioxide and water using heterogeneous photocatalysts. After successfully setting up a pilot plant to synthesise photo-semiconductors and after spectroscopically characterising them and studying their kinetics, experiments on the single-stage photocatalytic reduction of CO<sub>2</sub> indicated that the reaction would proceed at a very low rate due to the large overpotentials present. To overcome these kinetic barriers, a two-stage process was developed in which the generation of hydrogen and the subsequent hydrogenation of carbon dioxide were decoupled in time. The photocatalytic generation of hydrogen can occur by the photoreforming of wastewater containing polyols or through a water-splitting reaction. Detailed studies of the anodic reaction network of the C2- and C3-polyol reforming reaction to carbon dioxide showed that the oxidation step and the C-C bond cleavage occurred via the same reaction mechanism. In this reaction, formaldehyde accumulates in the liquid phase due to the small adsorption constant and is then oxidised to formic acid as soon as the more strongly adsorbing intermediates (glycolaldehyde or formic acid) have been converted.

In a collaborative project with the Krischer and Rieger groups, silicon-based semiconductor surfaces were modified with nitrogen-containing organic residues (pyridines) in such a way that the CO<sub>2</sub> is absorbed from the aqueous phase so that electron transfer can occur from the surface to the bound CO<sub>2</sub>. These organomodified surfaces exhibited a significantly greater electrochemical activity for hydrogen generation and for the reduction of CO<sub>2</sub> to methanol and showed themselves to be both chemically and electrochemically stable. The reaction mechanism of the reduction of CO<sub>2</sub> on platinum elec-

trodes with dissolved pyridines was also studied. There were clear indications that adsorbed pyridine was involved – a finding that supports the concept of chemically binding the catalyst to the silicon surface.

The experimental work with homogeneous catalysts and on semiconductor surfaces were corroborated by theoretical studies. The calculations carried out in the Rösch group concerning a heterogeneous reaction mechanism focused initially on the reaction energies and activation barriers of the first two reaction steps. The calculations showed that on a ruthenium surface the CO<sub>2</sub> inserted preferentially either via the C atom or simultaneously via a C- and an O-centre, but not via an O atom alone, thus enabling initial hydride transfer to CO<sub>2</sub>. The pathways to the next important intermediates HCO and H<sub>2</sub>CO are assumed to proceed via the formate, for which the highest relative activation barrier is 97 kJ/mol. The highest barriers on the alternative pathways via CO are 110 kJ/mol (to form HCO) and 167 kJ/mol (to form COH), both of which are significantly higher than that for the formate-mediated path. Once H<sub>2</sub>CO has been formed, only two hydrogenation steps are needed to synthesise methanol with activation barriers of 49 kJ/mol and 127 kJ/mol respectively. In summary, the path via the formate is slightly energetically favoured compared with the direct route. These results provide a readily apparent explanation as to why HCOO<sup>-</sup> and CO<sup>-</sup> species are predominantly found on the surface.

The Department of Physical Chemistry focused on examining the photochemical properties of hybrid systems of metal clusters and semiconductors. A platform was developed that enabled the synthesis, characterisation and photocatalytic study of nanostructured semiconductors containing metal clusters of atomically precise composition. It could be shown that under the same loading conditions, the size of the cluster had a significant effect on the photocatalytic activity of the system. A conceptual model was also developed that can describe these effects and can be used in the design of customised photocatalysts.

## 2.5.2 Exploitation, commercialisation and dissemination of results

### AdCOO

Over the short- to medium-term, the adsorptive systems currently available will not be as cost-effective at capturing CO<sub>2</sub> from power plant flue gas streams as the wet scrubbing methods and solvents presently used. If a suitable adsorbent were to become available in future, adsorptive capture would reduce operating costs resulting in significantly lower carbon capture costs over the long-term.

Whether or not an adsorptive method of carbon capture can be deployed at a real power plant site will depend on how the price for CO<sub>2</sub> develops in future. The price is currently so low that wet scrubbing is practically the only method being used to capture CO<sub>2</sub>. There is also at present no policy framework that would suggest that the application of CCS technology is going to become any more likely in the near future. One possible initial application of CO<sub>2</sub> captured from power plant flue gases could be its use in enhanced oil recovery (carbon dioxide injection).

If at some point in the future economic conditions were to change so as to favour CCS technologies, the research findings and the structures established in the iC4 project could be used as the basis for developing and optimising the technologies studied in the project.

### **COOMem**

Although substantial progress was made during the project regarding the individual materials used for the separation and support layers, creating a composite material containing both layers was only possible by incorporation of an additional intermediate layer. As a result, the membrane materials cannot be used at present by the industry partner (WACKER) for CO<sub>2</sub> separation as originally planned without significant further development work and investment in commercialising the technology.

However, the improved understanding of the materials involved in the membrane separation process did enable the use of a non-coated membrane for an application in the consumer goods industry in which there was no requirement to create a composite of the (supporting) membrane and the separation layer.

### **COOMeth**

The COOMeth project showed that the newly developed bimetallic catalyst systems, particularly those involving Al<sub>2</sub>O<sub>3</sub>, exhibited improved performance levels compared with the benchmark reference system. It was also demonstrated that the reactor concept developed by MAN is suitable for the methanation reaction. The results therefore demonstrate the potential for future commercial exploitation.

### **PhotoCOO**

The direction of the research work and the implementation of the research programme were agreed and conducted in close collaboration with Clariant AG. A fundamentally new understanding of deactivation reactions in both homogeneous and heterogeneous catalysis was established that will be incorporated into the future development of high-performance catalysts.

## 2.6 SolarStep – Chemicals Research and Engineering

BMBF Project FKZ 033RC1103

Project Coordinator: Stefan Brendelberger, DLR

Project Partner: BASF SE, Deutsches Zentrum für Luft- und Raumfahrt e.V. (DLR), Karlsruher Institut für Technologie (KIT)

### 2.6.1 Introduction

#### 2.6.1.1 Pre-project status and background

Achieving the goal of restricting the long-term concentration of atmospheric CO<sub>2</sub> to below 450 ppm requires a significant reduction in global CO<sub>2</sub> emissions and the worldwide deployment of alternative technologies scaled for industrial use. Policy instruments in the form of ambitious carbon emissions targets and earmarked research funding both play a key role. The need to replace fossil-based energy carriers with renewable sources of energy is one of the greatest challenges of our time. According to figures from the International Energy Agency (IEA), global emissions of carbon dioxide reached a new record level of 30.6 gigatons in 2010. In order to limit global warming to 2 °C above pre-industrial levels, emissions will need to be reduced to 22 gigatons by the year 2035.

Hydrogen can play a decisive and central role in achieving this objective if it is used as a chemical building block for the production of chemical fuels that can provide long-term storage of renewable energy as well as being used in the transport sector. Additionally, large quantities of hydrogen can be used to convert fossil-based and renewables-based raw materials and CO<sub>2</sub> into useful chemical products. At present, the predominant means of generating hydrogen is from hydrocarbons, mainly via the steam reforming process or by the partial oxidation of natural gas. The generation of hydrogen from hydrocarbons is an established process that has been optimised in terms of energy efficiency but that nevertheless results in the emission of significant quantities of CO<sub>2</sub>.

In view of the stated climate action targets, any proposals involving the use of massive quantities of hydrogen will only have long-term viability if the hydrogen can be generated efficiently using renewable sources of energy. At the present moment, the renewable hydrogen technology that is furthest along the development path is that based on the electrolysis of water powered by

electricity from renewable sources. However, a number of factors continue to pose challenges, such as the efficiency of the renewable electricity generation and the temporal fluctuations in the supply of renewable electricity and the demands that this places on the operation of the electrolysis units.

An alternative concept for hydrogen generation is thermochemical water splitting. The idea of using redox materials to produce hydrogen was originally proposed in relation to nuclear power plants <sup>[1]</sup>. In contrast, the approaches currently being proposed involve the use of concentrated solar radiation to produce the high-temperature heat required <sup>[2-4]</sup>. Thermodynamic analyses of the process have highlighted the high theoretical potential that this approach seems to offer <sup>[5]</sup>. Early process concepts using a variety of redox materials were studied in a number of lab-scale research projects [6-11]. The SolarStep project builds on this preceding work and aims to identify and develop suitable materials, process concepts and component designs with a view to achieving the large-scale implementation of the technology. The project consortium, comprising BASF, DLR and KIT, offers the requisite level of expertise in the areas of material development and material characterisation, solar technology and solar process engineering and the industrial upscaling of chemical plants and processes.

## 2.6.2 Project description

### 2.6.2.1 Objectives and project implementation

#### **Choice of material**

The two-stage solar thermochemical water splitting reaction using redox materials has been studied for a number of years now around the world and is garnering increasing interest. There is also growing interest in using this approach for CO<sub>2</sub> splitting and in combining the two reactions to generate synthesis gas. The number of materials and material classes that have been studied for the purposes of such applications has grown considerably over the last few years. The materials studied differ from one another in terms of their composition, production process and their morphological characteristics. By comparing these materials it should be possible to identify the most promising candidates. The key criteria to be applied are the yields of H<sub>2</sub> or CO generated by an individual materials and its long-term stability. In addition, a search will be made for materials and material classes that have not so far been used for splitting H<sub>2</sub>O or CO<sub>2</sub> but that could potentially be used in this way. Particular attention will be paid to materials that allow rapid oxygen transport in the material. Special software tools will be deployed to filter out the most promising candidates from the huge number of possible material combinations.

Once the results of these initial studies are available, a selection of materials will be made that will then be analysed in greater detail by means of thermodynamic calculations. Thermodynamic methods are well suited to assessing and estimating the theoretical potential of a candidate material. The methods will be used to examine the H<sub>2</sub>O and CO<sub>2</sub> splitting reactions and the reduction reaction. This will enable estimates to be made of the conditions under which the reaction is thermodynamically favoured. Other criteria that will be used to further refine the selection of materials are the temperatures and oxygen partial pressures required in the reduction reaction. The most promising materials selected on the basis of these results will then be synthesised and experimentally characterised. Finally, the experimental data can be used in reactor and process models to simulate the use of these materials and to assess their potential for various applications.

### **Material characterisation**

In addition to determining the physical properties of the materials using standard methods, the process will be set up in a laboratory environment to enable chemical characterisation of the materials involved. Test benches will be set up that will allow the temperatures and atmospheric conditions that prevail during the reactor cycles to be reproduced. The measurement system comprises a thermogravimetric analyser coupled with a mass spectrometer (TGA-MS). This setup enables materials to be reduced under an inert gas atmosphere at temperatures of up to 1500 °C and permits testing of the H<sub>2</sub>O splitting reaction at temperatures of up to 1000 °C or the CO<sub>2</sub> splitting reaction at temperatures up to 1500 °C. The composition of the atmosphere was adjusted by means of mass flow meters, premixed test gases and an oxygen pump. While the experiment is running, changes in the sample mass are monitored and the composition of the product gas is determined mass spectrometrically. The combined analysis of these measurement values enables reaction progress to be inferred and the temporal development of the materials as they pass through the cycles of the redox process to be recorded. By standardising much of the measurement methodology and automating the measurement procedures, the test bench setup is suitable both for screening candidate materials and for their subsequent detailed characterisation.

To enable experiments to be carried out for longer periods, a special test bench was developed that allows the materials to be oxidised and reduced under homogeneous and reproducible conditions. A tube furnace was used that allowed the materials to be subjected to heating cycles with temperatures up to 1500 °C. The composition of the flushing gas was adjusted by using a combination of defined test gases, mass flow meters and a pre-drier; the product gas was analysed using a lambda oxygen sensor and mass spectrometer. The experimental setup enables the reaction yield to be tracked over multiple cycles and thus cycle stability determined. As the morpholog-



ical characteristics of the materials may well change during long-term testing, the materials are analysed using imaging techniques once testing has been completed.

### Concept development

The properties of the material determine how the reactions proceed under the relevant conditions. The materials therefore provide the framework within which the processes can be configured and optimised. Process optimisation is performed using computational simulation methods. Initially, the models are quite crude and are used, for example, to compute the energy balances of the two main reactions. However, the models are successively refined so that they are ultimately able to include and take account of all relevant process steps and mechanisms. If all of the key elements have been included in the model, an optimised concept can then be developed with respect to the overall system subject to the prevailing constraints and interactions.

One of the major challenges of solar thermochemical water and carbon dioxide splitting cycles are the high temperatures needed to reduce the redox materials. The desired reduction temperatures are typically above 1300 °C. Temperatures of this magnitude can be generated by concentrated solar power (CSP) but they also significantly restrict the choice of materials and components that can be used. Receiver reactors are used to introduce the solar radiation into the chemical reaction. Typically, the redox material is directly exposed to the concentrated radiation. A number of different receiver-reactor concepts for two-stage redox cycles have been proposed and some of them have been subsequently developed and tested. The design concepts and the physical configurations of these reactors differ significantly from one another often as a result of the structure of the redox materials used. While the

Fig. 72:  
Facility for testing the  
receiver systems  
(Source: DLR/Ernsting)





general feasibility of receiver reactors has been demonstrated, no concepts have been developed for the redox materials tested so far that address the issue of scalability and that have the potential to deliver high overall efficiency. In this project, a scalable approach is sought that is technologically and economically feasible when considered in terms of the overall system.

## 2.6.3 Results

### 2.6.3.1 What results were achieved? What are the most important advances compared to the situation at the start of the project?

#### Ceroxide redox material

Iron oxide and ferrite systems have been studied intensively in the past as they offer high hydrogen yields. In the pure iron(II) oxide system, the reduction temperature is above the melting point of the wüstite (1370 °C). This results in formation of a melt in conjunction with rapid surface loss and deactivation of the material [12, 13]. When mixed ferrite systems of type  $(\text{Fe}_{1-x}\text{Mx})_3\text{O}_4$  were used, the reduction temperature was lower. Material stability was improved by using a zirconia and yttria-stabilised zirconia support [14]. However, even with these materials, structural damage [15, 16] and degradation effects [17] have been observed as a result of the high temperatures involved.

Other well-known redox systems that have been studied are zinc oxide/zinc and tin oxide/tin [3, 11, 18, 19]. Both of these redox pairs suffer from the disadvantage that the reduction stage produces gas-phase reaction products. It is therefore necessary to rapidly quench the hot reaction gas after reduction to prevent the reduced metal recombining with the oxygen. Quenching the hot gas results in a large loss of exergy and a resulting decrease in efficiency.

Studies performed over the last few years have concentrated primarily on cerium oxide and mixed systems in which the cerium oxide is combined with, for example, zirconium dioxide or iron oxide [7, 10]. As cerium oxide has a high melting point and a relatively high oxygen-ion conductivity, it has become a kind of reference material for solar thermochemical redox processes. A disadvantage of the cerium oxide system is that when reduction is carried out at technically realisable temperatures (< 1500 °C) and oxygen partial pressures (>1 mbar), only a relatively low level of reduction can be achieved. As a result, the quantity of material that has to undergo the redox cycle is correspondingly large. Providing sufficient sensible heat to achieve the required reduction temperature therefore becomes a process engineering challenge. A number of recent studies have examined the better per-

formance expected from the use of doped cerium oxide [20] and perovskites [21]. The first candidate materials exhibiting an improved level of reduction have now been developed. For example, the degree of reduction obtained when using a suitably zirconium-doped ceria was about 50% greater than that achieved with pure cerium dioxide [20]. This example demonstrates that the material properties can be adjusted across a very wide range. However, as such adjustments also cause other material parameters to change, the interaction of the modified material with all other system components needs to be considered in order to be able to determine whether its use does indeed lead to an improvement in the overall process [22].

### Development of a new process concept

If the entire system is analysed, it is found that process engineering limits prevent the simple scaling-up of volumetric receiver reactors and existing redox materials. A concept was therefore developed in the SolarStep project that involved the use of particulate redox material in combination with a similarly particle-based heat-transfer medium [23]. This approach offers a variety of benefits principally due to the fact that it allows the individual process steps and their specific requirements to be decoupled from one another. This decoupling provides greater flexibility in the design and operation of

Fig. 73: Solar thermochemical cycle with indirect heat-coupling and heat-recovery using heat-transfer particles

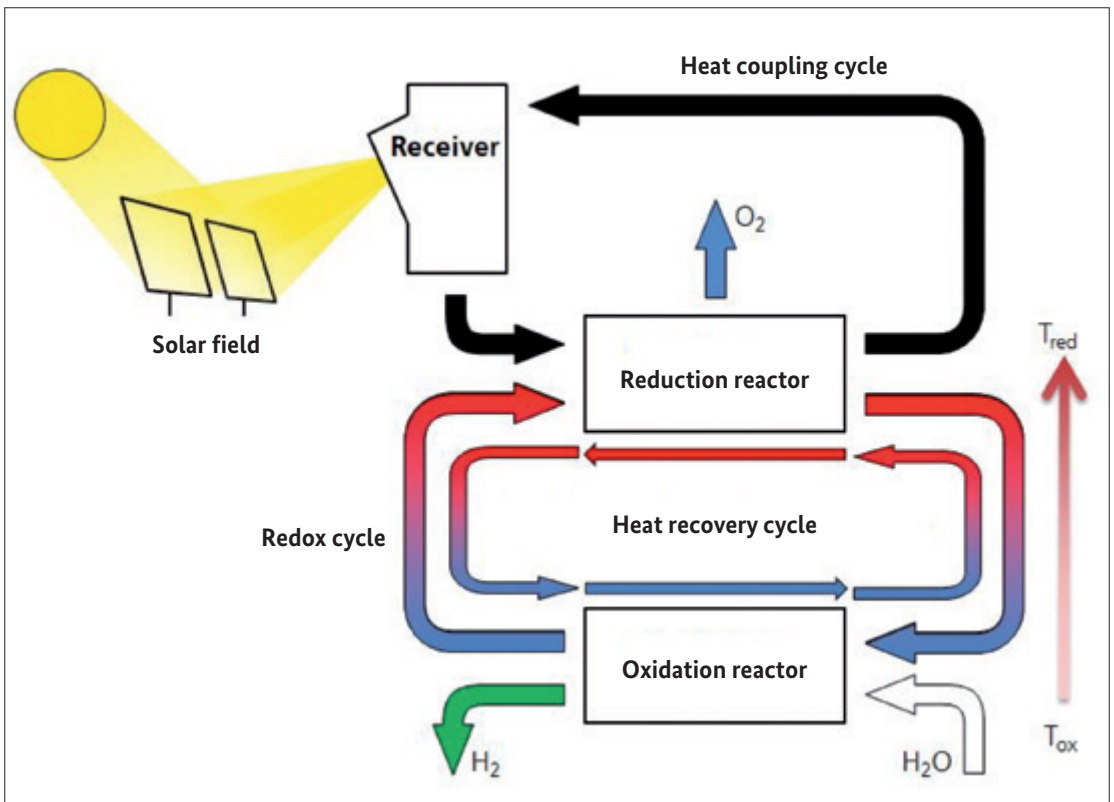

the process components. The use of a particle-based heat-transfer medium makes it possible to use open particle receivers to absorb the solar radiation and to deploy the heated particles in a separate reactor in order to supply the high temperatures needed when reducing the redox particles. The use of heat-transfer particles also enables the recovery of sensible heat from the reduced redox material [24, 25].

To examine the heat recovery process, a test rig was developed that enabled heat to be transferred between two particle streams. The test setup was used to quantify heat transfer at temperatures above 1100 °C. It could be shown that by allowing the two types of particles to mix, very high heat transfer rates could be achieved allowing contact times to be kept short. The proposed heat recovery concept involves a carefully configured multistage sequence that enables quasi-countercurrent heat transfer between the two particle types, achieving heat recovery rates of more than 50% [24-26].

The concept was incorporated into a process model in order to test the influence of different process parameters. The model showed, for example, that the energy required to drive the vacuum pumps can have a significant impact on process efficiency. The overall efficiency could therefore be determined as a function of the oxygen partial pressure in the reactor and optimised accordingly [25].

## 2.6.4 Exploitation, commercialisation and dissemination of results

### 2.6.4.1 How can the results be used in future? What are the realistic expectations?

SolarStep has generated valuable data and results regarding solar thermochemical cycles. This information has been disseminated via publications, presentations at international conferences and patent filings and is now part of the scientific debate. These new results provide further support for the proposition that solar thermochemical cycling is a promising technology and intensive research in the field is continuing as a result. The information, methods, concepts and test equipment that were generated and developed during the project are now being deployed in a variety of forms in other projects where they are undergoing further development and improvement.

The use of redox materials in particle form is one area of the project that has developed into an important area of current research that is being pursued in a number of locations. Interfaces with other projects addressing related issues are also being exploited, such as examining the use of particle receiver

systems in solar power towers. Another area of interest is in expanding capabilities for simulating process components that involve particles and in developing and experimentally testing such components.

The methods developed during the project enabled other interesting candidate materials to be identified and characterised. Work is also ongoing on additional test facilities that will allow the thermodynamic properties and the reaction kinetics to be determined more precisely.

Current projects that are directly related to SolarStep and that are benefiting from its results and findings are:

**SolarSynGas** (DLR, Clausthal University of Technology, KIT, Swiss Federal Institute of Technology in Zurich (ETHZ))

One of the core areas of the SolarSynGas project is material development using the methods, measuring instrumentation and test facilities developed in SolarStep. A number of highly promising candidate materials have been identified and their potential use has been assessed using full process models [20, 27]. The project is also continuing to develop and optimise the indirect process concept and its components [28]. Currently work is underway to design an indirect particle mix reactor that will then undergo initial lab-scale testing.

Fig. 74:  
Test setup in the DLR's  
high-power solar simulator  
used to study the irradiated  
redox particles under a  
reduced atmosphere  
(Source: DLR/Grobbe)

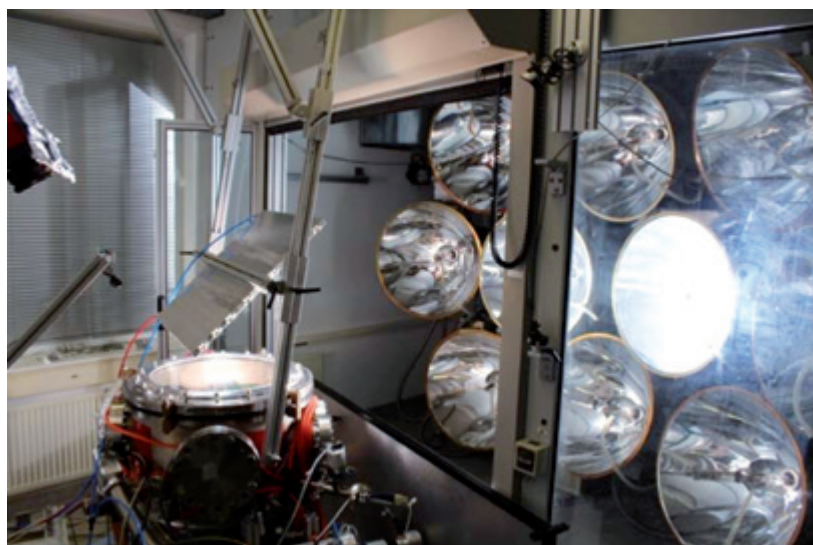

**Sun-to-Liquid** (Bauhaus Luftfahrt e.V., ETHZ, DLR, Fundación IMDEA Energía, Hygear Technology and Services BV, Abengoa Research SL, ARTTIC)

The Sun-to-Liquid project is studying the entire process chain for producing kerosene via solar thermochemical cycles and the technology is being demonstrated in a 30-kW solar reactor<sup>[29]</sup>. The solar reactor will be set up near Madrid, Spain and will be used to investigate the main process components and how they interact with one another. The project will draw on the experience gained in the SolarStep project in the areas of process simulation and heat recovery. By improving the design of the receiver, optimising process parameters and smart scale up, it is expected that process efficiency can be increased significantly compared with the current technology benchmarks.

**Hest-Hy / DOE STCH** (Sandia National Laboratories, Arizona State University, Bucknell University, Colorado School of Mines, DLR, Stanford University)

DLR's role in the Hest-Hy project, which is coordinated by Sandia National Laboratories (USA), is to develop and build a particle receiver reactor<sup>[30, 31]</sup>. The Hest-Hy project makes use of the pressure cascade approach developed as part of SolarStep in order to reduce the amount of energy required to remove the oxygen released in the reactor<sup>[25]</sup>. It also draws on process modelling and simulation experience gained during SolarStep.

### References:

1. Yalcin, S., *A review of nuclear hydrogen production*. Int. J. Hydrogen Energy, 1989. **14**(8): p. 551-561.
2. Fletcher, E.A. and R.L. Moen, *Hydrogen and Oxygen from Water - The use of solar energy in a one-step effusional process is considered*. Science, 1977. **197**: p. 1050-1056.
3. Steinfeld, A., *Solar hydrogen production via a two-step water-splitting thermochemical cycle based on Zn/ZnO redox reactions*. International Journal of Hydrogen Energy, 2002. **27**(6): p. 611-619.
4. Nakamura, T., *Hydrogen production from water utilizing solar heat at high temperatures*. Solar Energy, 1977. **19**: p. 467-475.
5. Kodama, T. and N. Gokon, *Thermochemical Cycles for High-Temperature Solar Hydrogen Production*. Chem. Rev, 2007. **107**(10): p. 4048-4077.
6. Roeb, M., et al., *Solar Hydrogen Production by a Two-Step Cycle based on Mixed Iron Oxides*. Journal of Solar Energy Engineering, 2006. **128**(May 2006): p. 125-133.
7. Chueh, W.C., et al., *High-flux solar-driven thermochemical dissociation of CO<sub>2</sub> and H<sub>2</sub>O using nonstoichiometric ceria*. Science, 2010. **330**(6012): p. 1797-1801.
8. Diver, R.B., et al., *Solar Thermochemical Water-Splitting Ferrite-Cycle Heat Engines*. Journal of Solar Energy Engineering, 2008. **130**(4): p. 41001-41008.
9. Ishihara, H., et al., *Two-step water-splitting at 1273-1623 K using yttria-stabilized zirconia-iron oxide solid solution via co-precipitation and solid-state reaction*. Energy, 2008. **33**(12): p. 1788-1793.
10. Abanades, S. and G. Flamant, *Thermochemical hydrogen production from a two-step solar-driven water-splitting cycle based on cerium oxides*. Solar Energy, 2006. **80**(12): p. 1611-1623.
11. Abanades, S., et al., *Novel two-step SnO<sub>2</sub>/SnO water-splitting cycle for solar thermochemical production of hydrogen*. International Journal of Hydrogen Energy, 2008. **33**(21): p. 6021-6030.
12. Sibieude, F., et al., *High temperature experiments with a solar furnace: The decomposition of Fe<sub>3</sub>O<sub>4</sub>, Mn<sub>3</sub>O<sub>4</sub>, CdO*. International Journal of Hydrogen Energy, 1982. **7**(1): p. 79-88.
13. Kodama, T., N. Gokon, and R. Yamamoto, *Thermochemical two-step water splitting by ZrO<sub>2</sub>-supported Ni<sub>x</sub>Fe<sub>(3-x)</sub>O<sub>4</sub> for solar hydrogen production*. Solar Energy, 2008. **82**(1): p. 73-79.
14. Kodama, T., et al., *Thermochemical hydrogen production by a redox system of ZrO<sub>2</sub>-supported Co(II)-ferrite*. Solar Energy, 2005. **78**(5): p. 623-631.
15. Siegel, N., et al. *Reactive structures for two-step thermochemical cycles based on non-volatile metal oxides*. in *Proceedings of the ASME 2009 3rd International Conference of Energy Sustainability (ES2009)*. 2009. San Francisco, California, USA.
16. Gokon, N., et al., *Thermochemical two-step water-splitting reactor with internally circulating fluidized bed for thermal reduction of ferrite particles*. International Journal of Hydrogen Energy, 2008. **33**(9): p. 2189-2199.
17. Roeb, M., et al., *Operational strategy of a two-step thermochemical process for solar hydrogen production*. International Journal of Hydrogen Energy, 2009. **34**(10): p. 4537-4545.
18. Vishnevsky, I. and M. Epstein, *Tin as a Possible Candidate for Solar Thermochemical Redox Process for Hydrogen Production*. Journal of Solar Energy Engineering, 2009. **131**(2): p. 21007-21007.
19. Loutzenhiser, P.G., et al., *CO<sub>2</sub> Splitting via Two-Step Solar Thermochemical Cycles with Zn/ZnO and FeO/Fe<sub>3</sub>O<sub>4</sub> Redox Reactions II: Kinetic Analysis*. Energy & Fuels, 2009. **23**(5): p. 2832-2839.

20. Call, F., et al., *Ceria Doped with Zirconium and Lanthanide Oxides to Enhance Solar Thermochemical Production of Fuels*. The Journal of Physical Chemistry C, 2015. **119**(13): p. 6929-6938.
21. Scheffe, J.R., D. Weibel, and A. Steinfeld, *Lanthanum–Strontium–Manganese Perovskites as Redox Materials for Solar Thermochemical Splitting of H<sub>2</sub>O and CO<sub>2</sub>*. Energy & Fuels, 2013. **27**(8): p. 4250-4257.
22. Bulfin, B., et al., *Solar thermochemical hydrogen production using ceria zirconia solid solutions: Efficiency analysis*. International Journal of Hydrogen Energy.
23. Brendelberger, S. and C. Sattler, *Concept analysis of an indirect particle-based redox process for solar-driven H<sub>2</sub>O/CO<sub>2</sub> splitting*. Solar Energy, 2015. **113**(0): p. 158-170.
24. Felinks, J., et al., *Heat recovery concept for thermochemical processes using a solid heat transfer medium*. Applied Thermal Engineering, 2014. **73**(1): p. 1004-1011.
25. Brendelberger, S., et al. *Solid Phase Heat Recovery and Multi Chamber Reduction for Redox Cycles*. in *Proceedings of the ASME 2014 8th International Conference on Energy Sustainability*. 2014. Boston.
26. Felinks, J., et al., *Particle–particle heat transfer coefficient in a binary packed bed of alumina and zirconia-ceria particles*. Applied Thermal Engineering, 2016. **101**: p. 101-111.
27. Bulfin, B., et al., *Oxidation and Reduction Reaction Kinetics of Mixed Cerium Zirconium Oxides*. The Journal of Physical Chemistry C, 2016. **120**(4): p. 2027-2035.
28. Brendelberger, S., et al., *Particle Conveyer for Solar Thermo-Chemical Processes and Related Solid Heat Recovery Systems*. ASME 10th International Conference on Energy Sustainability, 2016. **ES2016-59577**: p. 1-9.
29. Sizmann, A., et al., *Producing Sustainable Fuels for Aviation with Concentrated Solar Energy*, in *Energetica International 2016*: Spain. p. 48-49.
30. Ermanoski, I., et al., *Design and Construction of a Cascading Pressure Reactor Prototype for Solar-Thermochemical Hydrogen Production*. SolarPACES 2015 AIP Conference Proceedings, 2016. **1734**: p. 1200011-1200018.
31. Brendelberger, S., et al., *Counter flow sweep gas demand for the ceria redox cycle*. Solar Energy, 2015. **122**: p. 1011-1022.

## 2.7 HyCats – New catalysts and technologies for solar chemical hydrogen production

BMBF Project FKZ 033RC1012

Project Coordinator: Dr. Sven Albrecht, H.C. Starck GmbH

Project Partner: H.C. Starck GmbH, Universität Bonn, Leibniz Universität Hannover, Leibniz Institut für Katalyse, DLR Köln, ODB-Tec GmbH & Co. KG, Zinsser Analytic GmbH

### 2.7.1 Introduction

The term ‘solar chemical hydrogen production’ refers to the concept of using sunlight to generate hydrogen fuel. It represents a very elegant means of storing and transporting renewable energy. Compared with hydrogen production via photovoltaics and water electrolysis, the technology required for photocatalytic hydrogen generation is considerably simpler and therefore offers greater potential for reducing process costs. The potential service life of a photocatalytic system is also significantly longer, as no corrosive electrolyte solutions are involved.

If hydrogen is to be generated sustainably, renewable primary sources of energy will need to be deployed. It therefore seems worthwhile to examine the use of solar energy for this purpose as it is the largest available source of energy. As there are a number of different means of harnessing solar power to produce hydrogen, the method offering the greatest advantages for the application being studied in this project needs to be identified. The crucial factors are energy conversion efficiency, the system’s operating life, the capital investment required, and the system’s operating and maintenance costs. Analysing these factors leads to the conclusion that – as in a photovoltaic system – the most practicable approach is to keep the reactors relatively simple and to generate the hydrogen at (comparatively) low temperatures.

As existing photocatalysts are not efficient enough or do not have a sufficiently long service life, they are not currently viable as a means of producing hydrogen economically. Solar hydrogen generation will become economical to operate if the efficiency and lifetime of the photocatalytic systems can be increased while also lowering the associated material and production costs. If solar hydrogen production is introduced to the market this will not only mean huge reductions in carbon dioxide emissions, but will also enable CO<sub>2</sub> to



be chemically combined with solar hydrogen to produce hydrocarbons. Local hydrogen generation would also be an attractive technology for achieving the decentralised supply of energy to domestic properties. If fuel cells in residential buildings could be supplied with solar hydrogen, this would also have the effect of simplifying the necessary power supply infrastructure.

## 2.7.2 Project description

The goal of the HyCats project is to provide scalable technology for the cost-effective production of hydrogen by solar-driven chemical systems.

The project partners from industry and from centres of applied and pure research will collaborate to develop and test new photocatalysts for water splitting and the associated reactor technology. The aim is that by the end of the project the industrial partners will have a toolbox available that consists of catalysts, development tools and reactors for photo-electrochemical hydrogen production and that will facilitate the rapid development of the technology into a marketable product.

The material development work was guided by the following criteria:

- Maximum efficiency
- Maximum lifetime
- Lowest possible material costs
- Long-term availability of the raw materials used.

Parallel syntheses were performed to generate large numbers of new semiconductor materials with a variety of compositions followed by rapid testing to identify active materials. In contrast to previously published high-throughput screening systems, the newly developed rapid tests included all of the reactions involved in the photochemical water splitting system and an analysis of the quantities of hydrogen and oxygen produced. Using catalytic activity as the guiding parameter, the catalyst composition, the co-catalysts, and the synthesis and calcination parameters were optimised. By iterating this process repeatedly and introducing new generations of catalysts, the project team was able to develop photocatalytic materials designed to make efficient use of solar energy in the production of hydrogen.

A fundamental understanding of the processes involved is required if the synthesis is to be planned in a rational way. The starting point was the

description of a parent system using theoretical chemical models in order to identify and understand the actual reaction steps occurring. The models were calibrated and verified by determining activity data and the physicochemical parameters of the photocatalysts, such as the lifetimes of the excited states after light absorption, band-edge potentials, etc. The chemical modelling work supported the development of the system for industrial use by enabling rational design of the co-catalysts and aspects such as particle size. This meant that the values of the parameters could be restricted for the subsequent development work (parallel syntheses) and optimisation strategy (genetic algorithms).

To optimise the way that these new photocatalysts are used, reactor concepts had to be adjusted and assessed in terms of their economic feasibility. A new solar reactor had to be designed that would offer improved productivity by taking moderately concentrated sunlight and irradiating the photocatalysts with a radiation density that was as uniformly distributed as possible. The guiding principle behind all of the material development and reactor design work was the scalability that would ensure future industrial-scale implementation of the technology.

### 2.7.3 Results

Different methods of synthesising semiconductors and their effect on physical properties such as the BET surface area and phase purity were examined. The semiconductor synthesis enabled the research team to gain a deeper understanding of the factors influencing photocatalytic activity.

During the HyCats project numerous tantalum and niobium compounds were synthesised and characterised, such as the phosphates and nitrides that are of potential interest for other applications like catalysing organic reactions, use as pigments and electroceramics. The results and experience acquired during this work can now be used in other research projects examining new applications of tantalum and niobium compounds.

Within the HyCats project, the efficiency of photocatalytic hydrogen production was improved significantly. The highest reproducible hydrogen production rates were about 40  $\mu\text{mol/h}$  at radiation wavelengths above 420 nm, which were measured for a C-modified titanium oxide and for a tin niobate.

However, the photocatalytic systems identified so far are still not economically viable. However, the collaborative interaction between teams involved in basic research, applied research and industry resulted in the development of a toolbox that will enable further rapid development of photo-electrochemical hydrogen production systems and facilitate the future cost-effi-

cient generation of hydrogen. The toolbox comprises quantum chemistry simulation techniques for calculating band gaps, doping effects and surface reactions as well as spectroscopic methods aimed at uncovering the underlying reaction mechanisms. These techniques will provide a deeper understanding of photocatalytic water splitting, boosting the efficiency of these systems in future. High-throughput syntheses and activity measurements using a rapid screening system integrated into a synthesis robot and production techniques for upscaling the synthesis of photocatalysts are other elements that will help to develop photocatalytic water splitting and bring the technology to market. The construction of the SoCRatus test facility (solar concentrator with a rectangular flat focus) and the development of methods to fabricate photocatalyst electrodes will accelerate technology development by allowing lab data to be evaluated in field testing campaigns. The toolbox is finding continued use and is therefore contributing to achieving Germany's stated climate action targets.

The development work on inorganic photocatalysts for use in hydrogen production generated a large number of findings relating to semiconduc-

Fig. 75:  
 (a) The two-axis tracking solar concentrator;  
 (b) the irradiated receiver

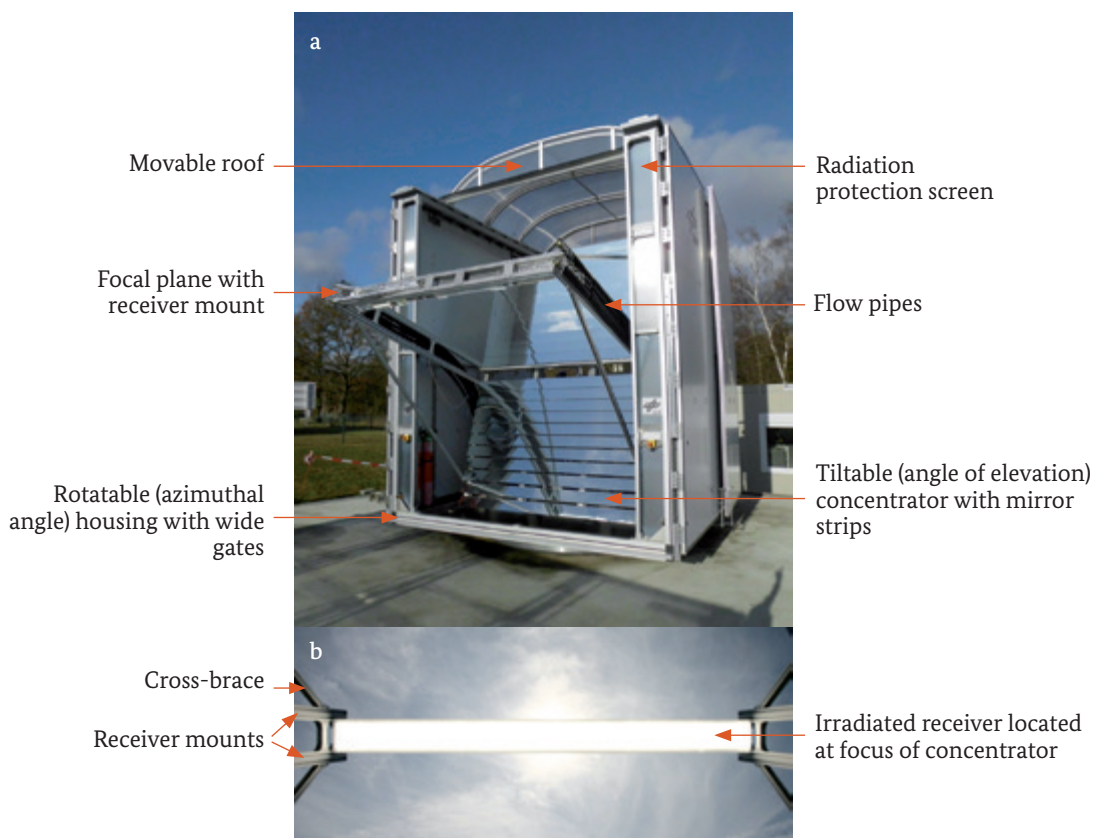

tor syntheses and how their physical properties can be influenced by controlling the production parameters. Correlations were also established between catalytic activity and the physicochemical properties of the photocatalysts. These results allow useful conclusions to be drawn regarding the optimal configuration of material properties for photocatalysts used in other applications such as photochemical syntheses and photochemical water purification.

## 2.7.4 Exploitation, commercialisation and dissemination of results

The results produced during the HyCats project were included in academic dissertations, published in scientific journals and presented at scientific and technical conferences. They are also being used in ongoing photocatalyst development work. Access to the HyCats toolbox will be available to HyCats project partners through bilateral cooperation agreements, such as photocatalyst testing in the solar concentrator SoCRatus operated by DLR. The efficiency achieved so far in solar chemical hydrogen production is still too low for these photocatalysts to be marketed for this purpose at the current time.

Nevertheless, during the project numerous tantalum and niobium compounds were synthesised and characterised and many of these are of interest for other technical applications. The results from the HyCats project will therefore continue to be exploited in other research projects. At present, some of the synthesised Ta/Nb compounds and new synthetic routes are being tested for their suitability for other commercial applications. Examples of such applications include industrial catalysts for organic syntheses, pigments and electroceramics, such as lead-free piezo-ceramics. Of particular interest in this regard are the synthetic routes that achieve high BET surface areas.

The rapid catalyst screening facility that was set up also permits other reactions to be examined. The results and experience gained from the HyCats project can be applied to other research projects that are addressing similar environmentally relevant issues. The photocatalytic purification of water and air are examples of two such topics that could benefit from this sort of approach. Spectroscopic analysis in high-throughput systems can be applied to many substance classes and is therefore an analytical instrument of universal character. The methods of synthesis and particularly the polymerisation techniques developed in HyCats will be used for the high-throughput preparation of mixed oxide catalysts for other heterogeneous catalysis reactions, such as selective oxidations. These techniques allow the fabrication of mixed catalysts that exhibit a very homogeneous distribution of elements.

Under the assumption of an irradiance of 20 Suns (= 20,000 W/m<sup>2</sup>), a square-metre price of 900 euros (catalyst electrode + reactor costs) and a lifetime of 15 years, grid parity can be achieved if the hydrogen production system operates with an efficiency of about 10%. One of the photocatalysts identified in the HyCats project yielded in suspension a solar efficiency of approximately 0.78%.



## 3.1 Carbon capture

*Prof. Dr.-Ing. habil. Klaus Görner  
Universität Duisburg-Essen, Lehrstuhl für Umweltverfahrenstechnik  
und Anlagentechnik (LUAT)*

### 3.1.1 Introduction

The threat of global warming and the continued consumption of finite reserves of fossil resources represent global challenges to society. The main cause of climate change is anthropogenic emissions of carbon dioxide (CO<sub>2</sub>) and other climatically relevant gases that lead to an increase in the temperature of the Earth's atmosphere and thus to changes in the levels of water vapour in the atmosphere. Emissions of carbon dioxide (often referred to simply as carbon emissions) therefore have to be drastically reduced. In addition to transitioning from an energy system based on fossil fuels to one based on renewable sources of energy, such as wind and solar power, important contributions may also come from capturing carbon dioxide and then binding it long-term or reusing it in continuous closed cycles. The advantage offered by continuous closed material cycles in which CO<sub>2</sub> is used as a material resource is that it reduces consumption of fossil resources. Public acceptance of carbon sequestration in the form of underground storage of CO<sub>2</sub> is low in

Germany, though globally it is seen as an important climate protection factor (IEA, see [1]). The technologies used for the capture and storage of carbon dioxide are generally referred to by the abbreviation CCS, which stands for 'carbon capture and storage' or 'carbon capture and sequestration'. The abbreviation CCU refers to carbon capture and utilisation, which is the entire process chain comprising the separation or capture of the CO<sub>2</sub>, compression of the gas under high pressure so that it can be transported economically, and finally, utilisation as a feedstock for the production of methane, methanol or other carbon-containing chemicals. Technologies within the CCU portfolio include Power-to-X (P2X) technologies in which available excess electric power drives electrolytic processes whose products are combined with captured CO<sub>2</sub> to synthesise new products. This is illustrated graphically in Figure 1. If the focus is on carbon capture (shown in the upper left of the figure), the figure can be thought of as representing the CCU chain. If the focus is on the use of excess electricity (see lower left), then the figure can be seen as representing the various P2X technologies, such as P2G (Power-to-Gas), P2F (Power-to-Fuel) and P2C (Power-to-Chemicals). Another P2X technology, Power-to-Heat, will not be considered further here as it does not involve the utilisation of CO<sub>2</sub>.

At the core of all of these process chains is the carbon capture stage, which will be described in more detail in what follows. The reader is also referred to the literature for further information (see Refs. [1], [2] and [3]).

## 3.1.2 Classification and use of the different carbon capture technologies

### 3.1.2.1 Classification of carbon capture methods

A number of different physicochemical processes can be used to separate carbon dioxide from an industrial flue gas or exhaust gas stream:

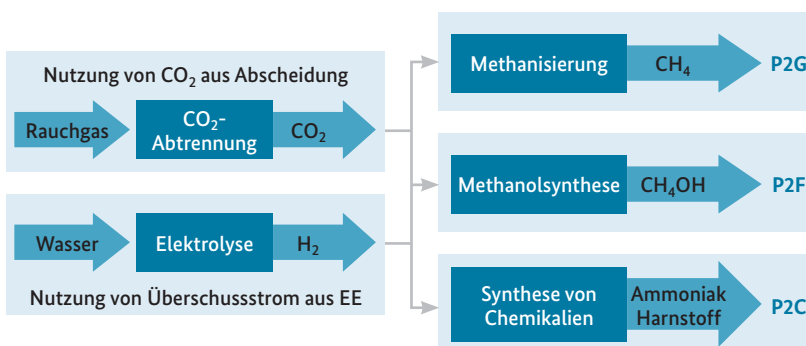

Fig. 76:  
CCU and P2X technologies

These include:

- Absorption techniques
- Methods using gas-solid reactions
- Adsorption techniques
- Cryogenic methods
- Membrane separation techniques
- Processes based on natural incorporation.

Further sub-classification of these methods is possible (see Figure 76) in terms of the physical and chemical principles applied, the chemical absorbents, physical absorbents or adsorbents and/or special methodologies used.

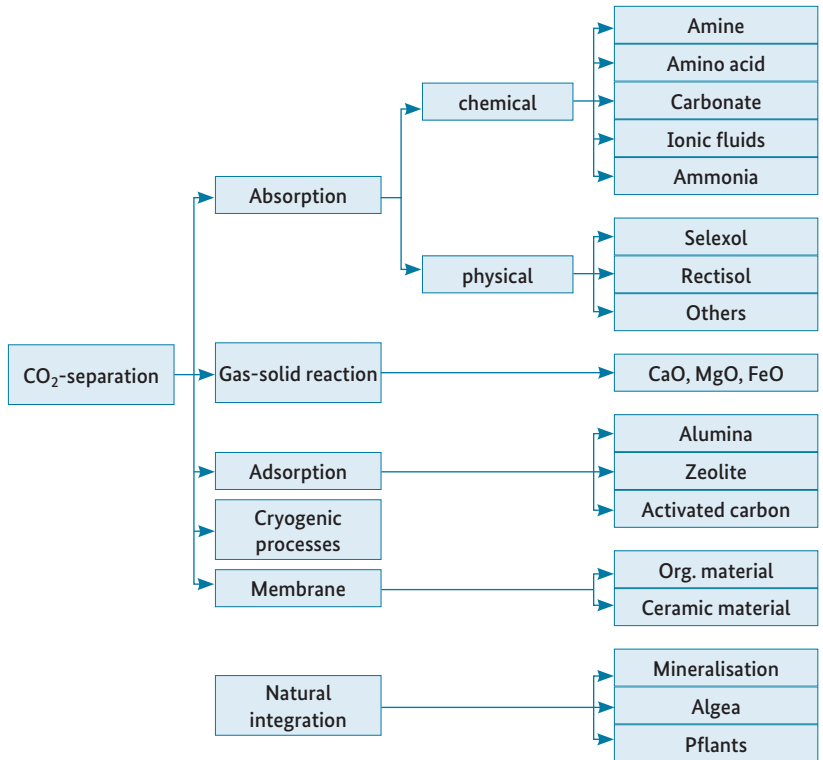

Fig. 77: Classification of CO<sub>2</sub> capture systems in terms of physical and chemical principles and processes, and the associated solvents, absorbents, adsorbents etc. used [1]



### Methods using gas-solid reactions

In this group of carbon capture methods, a gas-solid reaction is used to bind the CO<sub>2</sub> to a solid, typically a solid metal oxide. The CO<sub>2</sub> is chemically bound as a carbonate. The apparatus in which the reaction takes place is known as a carbonator. The most frequently used solid is calcium oxide (CaO), which is an inexpensive material that reacts with CO<sub>2</sub> to form calcium carbonate (CaCO<sub>3</sub>). After the CO<sub>2</sub>-depleted flue or exhaust gas and the carbonate have been separated, the latter is then thermally decomposed in a calcinator to regenerate CaO and CO<sub>2</sub>. The high purity CO<sub>2</sub> is then collected and utilised elsewhere, while the CaO is returned to the calcinator.

### Adsorption techniques

The physical adhesion of molecules onto a surface (interface) is known as physical adsorption or physisorption, as it is not the result of chemical bonding but of purely physical (van der Waals) forces. When used for carbon capture, the carbon dioxide becomes attached to the surface of the adsorbent. However, as the CO<sub>2</sub> molecules also have a propensity to leave (i.e. desorb from) the surface, an equilibrium becomes established between the opposing processes of adsorption and desorption. The position of this equilibrium will depend on the pressure, the concentration of the species being adsorbed, and the temperature, properties and size of the adsorbing surface.

### Cryogenic methods

Cryogenic carbon capture techniques use the fact that different gas components exhibit different condensation and sublimation temperatures. Cryogenic capture is a physical separation method. It typically involves condensing out components such as water vapour from the flue gas stream. For it to work as a carbon capture technique, the flue gas must not contain any components with condensation temperatures lower than that of carbon dioxide. This is why cryogenic capture is used in combination with the oxy-fuel process in which the fuel undergoes combustion in pure oxygen (rather than air) thus ensuring that lower boiling nitrogen is not present in the flue or exhaust gas stream.

### Membrane separation techniques

This group of carbon capture techniques use membranes to separate atoms and/or molecules. Depending on their size, these particles either pass through the pores of the membrane material at different rates or are retained by the membrane. Membrane gas separation is a purely physical separation method. As membrane separation occurs without the need for heat energy, it usually uses less energy than other (thermal) separation techniques. One disadvantage is the large membrane areas that are required, which leads to very large filtration units or plants.

**Physical absorption techniques**

If atoms or molecules are dissolved in liquids, the process is referred to as physical absorption. When physical absorption is used for carbon capture, the CO<sub>2</sub> is physically bound to the absorbing material (absorbent) by intermolecular forces (typically van der Waals forces). The resulting equilibrium can be described at low concentrations of solute by Henry's law (ideal dilute solution) and at high concentrations of solute by Raoult's law (ideal solution).

**Chemical absorption techniques**

In carbon capture by chemical absorption, the CO<sub>2</sub> in a flue gas stream initially bonds chemically to an absorbent (also referred to as the 'solvent'). The CO<sub>2</sub>-enriched absorbent and the flue gas are separated and the CO<sub>2</sub> is then stripped from the absorbent by thermal desorption after which it can be utilised for other purposes. Chemical absorption technology is the most common of the carbon capture processes.

Three aspects need to be taken into account when designing, adapting or optimising the technical configuration, operation and cost-efficiency of a carbon capture process. These are:

- Choice of solvent (see Section 3.1.3.1)
- Design of the actual capture process (see Section 3.1.3.2)
- Integration into the larger process (power plants, industrial production process; see Section 3.1.3.3).

**3.1.2.2 Use of carbon capture technology in different industrial processes (power plants, thermoprocessing equipment, etc.)**

In view of the carbon dioxide emission levels associated with the energy industry, carbon capture technology is probably most usefully applied to this sector. The focus here is on large-scale centralised power plants that act as major point sources of CO<sub>2</sub>.

These power generating plants burn fuel, mostly of fossil origin, and use the heat contained in the flue gas to generate steam, which is used to drive steam turbines and generate electricity. As it is the flue gas that contains the carbon dioxide, the carbon capture technology is applied after the fuel has been burned, and this type of carbon capture technology is therefore referred to as PCC (post-combustion capture). Combustion is also the first process stage in many types of thermoprocessing equipment, where it is often used to generate a hot exhaust gas, thus making PCC a viable capture technology.

Although the principles underlying what is known as ‘gasification technology’ are fully developed, the technique has yet to be utilised on a major industrial scale. In the power generation industry, high-pressure gasification of coal can be carried out in integrated gasification combined cycle (IGCC) plants. The process can be thought of as a combination of gas turbine and steam turbine stages where the fuel gas for the gas turbine stage is generated (from coal) in an integrated gasifier unit. Carbon and its compounds, such as CO and CO<sub>2</sub> are separated from the fuel gas exiting the gasifier before the gas is combusted. This is why this method of carbon capture is referred to as pre-combustion capture.

In the oxy-fuel combustion capture process, combustion occurs in pure oxygen, i.e. in the absence of the nitrogen present in air. The resulting flue gas therefore consists mainly of water vapour and carbon dioxide. Cooling the flue gas stream allows the water vapour to condense leaving only CO<sub>2</sub> in the gas stream. However, the gas stream is still contaminated with a not insignificant number of trace components.

The three different carbon capture technologies are shown in Figure 78.

#### Power plant in which CO<sub>2</sub> separation occurs before fuel combustion (‘pre-combustion capture’)

In this process, carbonaceous fuels (e.g. coal, biomass or waste) are converted to syngas (also known as synthesis gas) at temperatures of between 1000 °C and 1700 °C in the presence of oxygen and steam (substoichiometric combustion) under high pressure in a gasifier. The necessary oxygen is usually generated in an integrated air separation unit. The syngas consists primarily of carbon monoxide and hydrogen. After clean-up, the syngas is transfor-

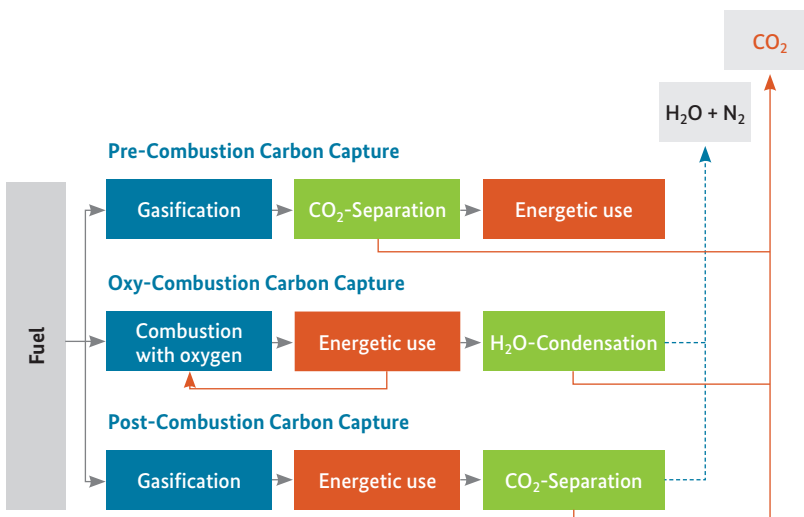
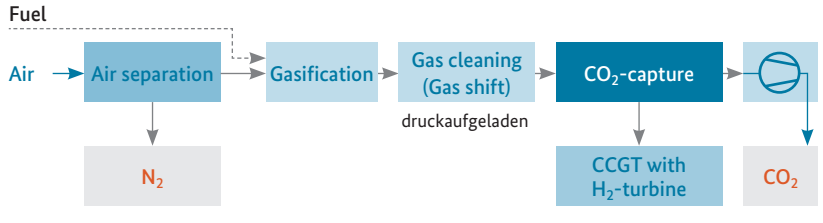

Fig. 78: Simplified schematic showing different ways in which carbon capture can be incorporated into fuel combustion processes [1]

med into CO<sub>2</sub> and H<sub>2</sub> in the presence of added steam in a water-gas shift reactor. It is at this stage, i.e. before any further combustion of the hydrogen occurs, that the CO<sub>2</sub>/H<sub>2</sub> stream is separated. Separation is carried out either by wet gas absorption or by membrane separation. Hydrogen can be used as a fuel in highly efficient combined-cycle power plants to generate electricity, or it can be used in fuel cells, as a substitute for natural gas or for synthetic fuels (see Fig. 79a).

Fig. 79a: Simplified schematic of a pre-combustion capture process



If the gasification unit (or ‘gasifier’) is integrated into the combined-cycle power plant, the overall process is referred to as integrated gasification combined cycle (IGCC) technology. IGCC technology has been used in power plants in the USA – but without carbon capture – since the 1980s and is also in use in Buggenum (the Netherlands) and in Puertollano (Spain).

Figure 79b provides details of the CO<sub>2</sub> capture process.

**Oxy-fuel power plant with CO<sub>2</sub> capture (‘oxy-combustion capture’)**

A power plant that burns fossil fuels (e.g. a coal-fired plant) but uses pure oxygen instead of air in the combustion process is referred to as an oxy-fuel combustion plant (or ‘oxy-fuel plant’ or ‘oxy-combustion plant’). Here, too, an air separation unit is used to generate the oxygen.

Fig. 79b: Schematic of the carbon capture process in a combined cycle power generation plant with upstream gasification [1]

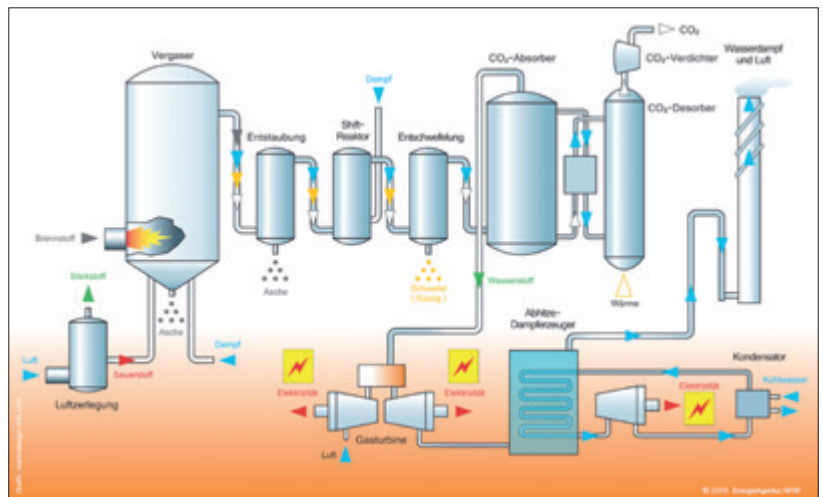

A conventional combustion process with air generates flue gas that, in addition to various trace substances, contains  $\text{CO}_2$ ,  $\text{H}_2\text{O}$  and inert nitrogen  $\text{N}_2$ . In the oxy-combustion process, the flue gas contains only  $\text{CO}_2$  and  $\text{H}_2\text{O}$ .

The water can be removed by condensing it cryogenically, i.e. by cooling the flue gas stream below the condensation temperature of the water vapour, leaving a  $\text{CO}_2$ -rich gas stream. As combustion with pure oxygen would lead to unacceptably high temperatures, most of the cleaned and cooled flue gas has to be returned to the boiler (Fig. 80a). As a result, the  $\text{CO}_2$  stream becomes enriched with components such as  $\text{SO}_2$ , whose removal has a negative effect on the cost effectiveness of the overall process.

A simplified schematic of the carbon capture and flue gas cleaning process is shown in Figure 80b

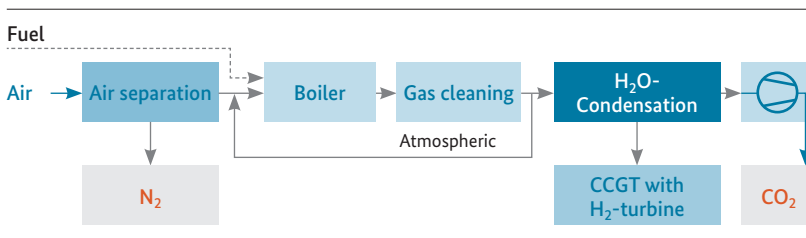

Fig. 80a: Simplified schematic of an oxy-combustion capture process

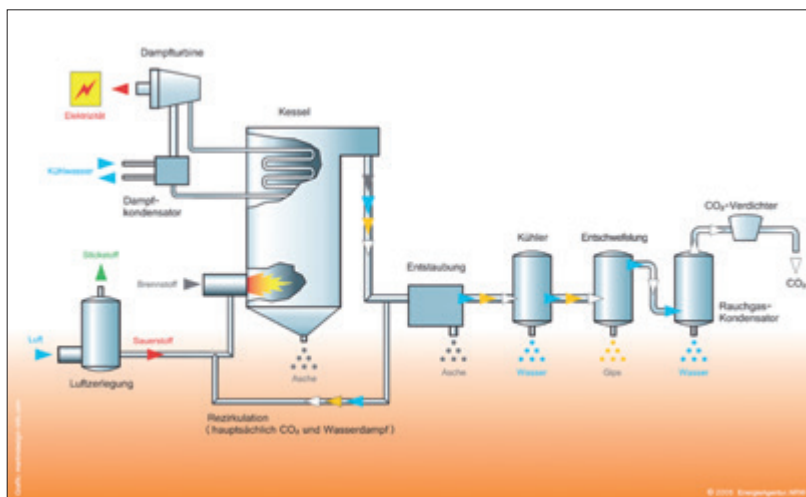

Fig. 80b: Schematic of carbon capture stage in an oxy-fuel steam turbine cycle [1]

**Power plant in which CO<sub>2</sub> separation occurs after fuel combustion ('post-combustion capture')**

In a conventional fossil fuel power plant, the fossil fuel is burned and the hot flue gases used to create steam that drives a steam turbine that powers a generator creating electricity. The downstream flue gas cleaning stage removes most of the dust, sulphur oxides and nitrogen oxides. If CO<sub>2</sub> separation occurs after the flue gas clean-up stage, it is referred to as post-combustion capture (Fig. 80c).

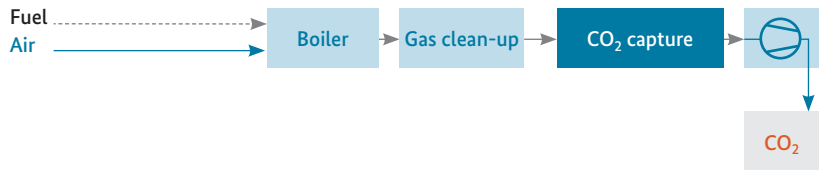

Fig. 80c: Simplified schematic of an oxy-combustion capture process

The advantage of capturing the CO<sub>2</sub> from the flue gas stream after combustion and after flue gas cleaning is that it can be added on to existing power plants provided that certain conditions are met. Existing power plants can therefore be retrofitted with this carbon capture technology. Power plants currently under construction or that are in the planning stage need to be designed to be 'capture ready' so that they can be converted to incorporate PCC technology.

A simplified schematic of the carbon capture and flue gas cleaning process is shown in Figure 80d.

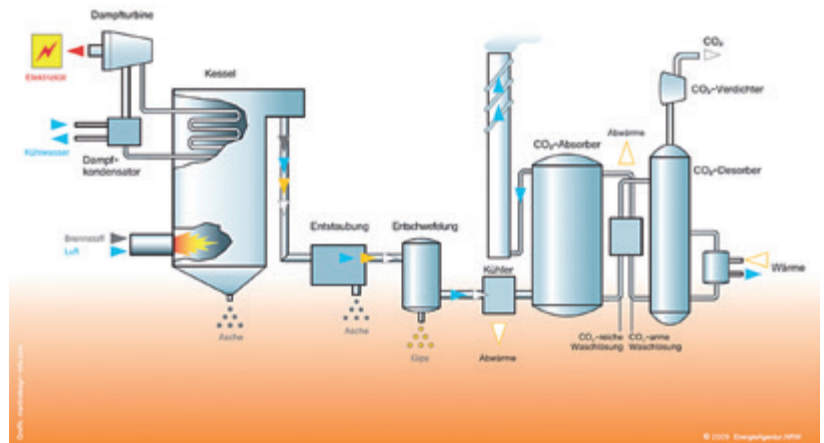

Fig. 80d: Schematic illustration of a power plant with post-combustion carbon capture

### 3.1.2.3 Assigning the basic physicochemical separation principles to the three carbon capture technologies

The physicochemical processes that can be used for capturing carbon dioxide and the three main carbon capture technologies were outlined in Section 3.1.2.1 and 3.1.2.2 respectively. More detailed information can be found in the references [4], [5], [6] and [7]. Table 1 provides a rough initial guide as to which of the underlying physicochemical separation processes can be associated with each of the carbon capture technologies.

Table 1: Assigning the different physicochemical separation techniques to the three main carbon capture technologies

Separation process	Pre-combustion capture	Oxy-combustion capture	Post-combustion capture
Chemical absorption	Yellow	Light Blue	Green
Physical absorption	Green	Light Blue	Red
Adsorption	Red	Light Blue	Red
Cryogenic capture	Red	Light Blue	Red
Membrane separation	Yellow	Light Blue	Yellow
Natural incorporation	Yellow	Light Blue	Yellow
Condensation of a component	Light Blue	Green	Light Blue

- Process of choice
- Possible process, but may not be cost-effective
- Process currently under development
- Process is not relevant

The overview above allows the following conclusions to be drawn:

- For pre-combustion capture technology, CO<sub>2</sub> capture by means of physical absorption is preferred (because of the high pressure at which the syngas is formed)
- For oxy-combustion capture, a cryogenic method is preferable (condensation of water vapour)
- For post-combustion capture technology, almost all separation processes can be used (preference is for chemical absorption).

The strength of the associations shown in the table above range from the simple compatibility of a particular physicochemical separation technique with a particular carbon capture technology to pairings that reflect the current state of the art in industrial applications.

For any real-life application, an assessment has to be made based on the individual weighting of the relevant technical and economic factors. The matrix shown above should therefore only be used to assist in the initial selection of suitable CO<sub>2</sub> separation technique for use in a particular application.

In thermal, fossil-fuel-fired power plants and thermoprocessing equipment, the primary energy source is converted by means of a conventional combustion process. The following sections therefore focus on the selection and use of an amine-based chemical absorption method and explain a number of the important process design parameters.

### **3.1.3 Chemical absorption as a post-combustion carbon capture process for a power plant**

#### **3.1.3.1 Choice of solvent (absorbent)**

Using chemical absorption to remove CO<sub>2</sub> from the flue gas stream in a post-combustion process typically involves selecting one of the following substance classes as the liquid solvent:

- Alkanolamines
- Alkali carbonates
- Amino acid salts
- Ionic liquids
- Ammonia.

The two most important properties in selecting the solvent are:

- The rate of reaction for the CO<sub>2</sub> absorption step
- The energy requirements for the absorption step and for the desorption of bound CO<sub>2</sub>.



Ideally, the reaction rate should be as high as possible and the energy requirements as low as possible. The reaction rate ultimately dictates the height of the absorption tower, which in turn influences the energy requirements of the process and thus the cost of carbon capture.

Other properties of the absorbent, such as its

- CO<sub>2</sub> loading capacity
- Degradation
- Corrosion behaviour
- etc.

are also important for the technical and cost-efficient operation of the carbon capture process. The criteria used to assess these properties are described in detail in [1].

The most common chemical absorbents used for carbon dioxide capture are the amines. A 30% aqueous solution of monoethanolamine (MEA) has become the benchmark solvent against which other amines or absorbents are measured in terms of their reaction kinetics and their energy requirements.

Choosing an amine from this very broad class of substances is done on the basis of the following criteria:

- Reaction kinetics
  - Mass transfer
  - Reaction system and phase equilibrium
- Loading capacity
- Enthalpy of absorption.

The key to determining the reaction rate is the reaction rate constant  $k$  as defined in Eq. 1:

$$\frac{dc_{CO_2}}{dt} = \frac{dc_{Sorbens}}{dt} = k c_{CO_2} c_{Amin} \quad \text{Eq. 1}$$

Values of  $k_0$  for a variety of absorbents are listed in Table 2 (from [1]).

Table 2: Reaction rate constants  $k$  for three different amines and piperazine ([1])

Solvent (absorbent)	$k$ [ $\text{m}^3/\text{mol}\cdot\text{s}$ ] at the specified temperature
MEA - monoethanolamine	7,7 (30 °C)
DEA - diethanolamine	3,2 (25 °C)
EDA - ethylenediamine	15,1 (25 °C)
PZ - Piperazine	53,7 (25 °C)

Example enthalpies of absorption for the three amines MEA, DEA and MDEA are presented in Table 3.

Table 3: Enthalpies of absorption for three amines [1]

Amine	MEA monoethanolamine	DEA diethanolamine	MDEA methyldiethanol- amine
$\Delta H_{\text{abs}}$ (20 °C) [GJ/ $t_{\text{CO}_2}$ ]	1.9	1.6	1.1
$\Delta H_{\text{abs}}$ (80 °C) [GJ/ $t_{\text{CO}_2}$ ]	2.1	1.7	1.2

Additional data can be found in [1].

### 3.1.3.2 The CO<sub>2</sub> separation process

The basic principles of a chemical absorption carbon capture process are illustrated in Figure 81. The core elements in the process are the absorber and desorber columns. A more detailed schematic is shown in Figure 82 in the form of a simplified P&ID in which the flue gas conditioning stage (pre-scrubbing with NaOH) and the main absorber/desorber stage are distinguished.

Fig. 81:  
Simplified process flow diagram  
of a CO<sub>2</sub> scrubber [1]

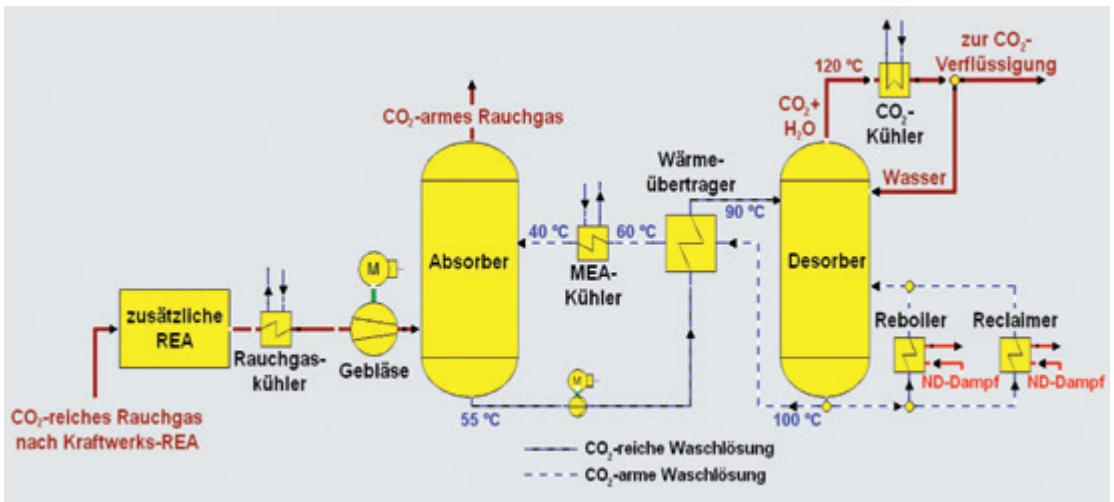

Before the flue gas reaches the actual absorber unit, it passes through a pre-scrubber, i.e. an additional flue gas desulphurisation (FGD) unit, in which the gas stream, which has already been through the power plant's own FGD system, is further purified to reduce the SO<sub>2</sub>/SO<sub>3</sub> content to a permissible level (max. 10 mg SO<sub>2</sub>/m<sup>3</sup>). Without pre-scrubbing, the SO<sub>2</sub>/SO<sub>3</sub> would chemically bond to the absorbent, thereby degrading it. The flue gas cooler located between the pre-scrubber and the absorber column cools the gas stream to a temperature between 35 °C and 50 °C depending on the solvent used and the conditions prevailing in the absorber tower. A flue gas blower is also located in front of the absorber to compensate for the pressure drop within the absorber. The absorber column can be configured as a spray tower or as a packed tower.

Flue gas desulphurisation is a well-established industrial process that has generated a considerable body of knowledge regarding the operation of spray towers. However, for the purposes of CO<sub>2</sub> separation, the low CO<sub>2</sub> absorption rate would require the use of very high spray towers. For this reason packed towers are generally preferred, with both structured packing or random packing configurations in use. In both cases, the flue gas stream containing the CO<sub>2</sub> flows upward through the column against a counter-current flow of the chemical absorbent. The lean-loaded solvent absorbs CO<sub>2</sub> from the gas stream

Fig. 82: Simplified P&ID of a CO<sub>2</sub> absorber unit with a two-part absorber column with integrated intercooling

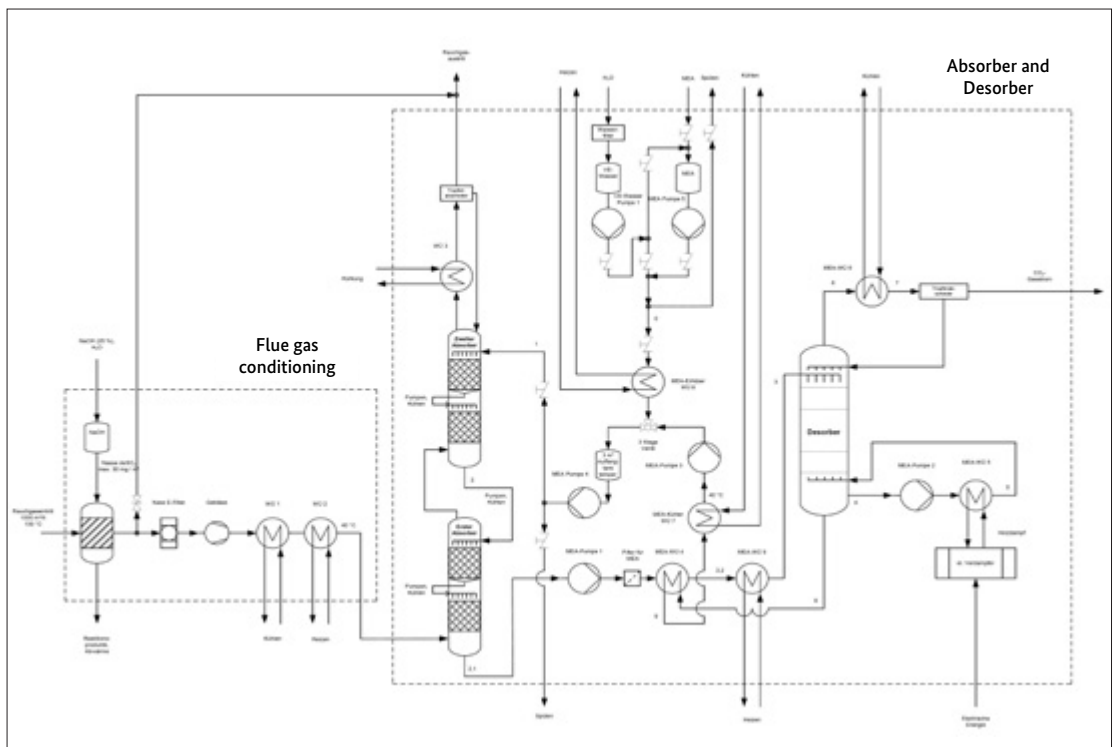

am becoming more CO<sub>2</sub>-rich as it does so, while the flue gas stream becomes progressively leaner in CO<sub>2</sub>.

The solvent is regenerated by first passing it over a heat exchanger and then into the desorber tower. The solvent is sprayed into the top of the desorber where it flows downward against a counter-current of steam that strips CO<sub>2</sub> from it. The flow of stripping steam is generated in the base of the column by applying heat (typically steam) to the aqueous solution of the chemical absorbent. The increase in temperature drives the desorption of CO<sub>2</sub> from the solvent stream, and the CO<sub>2</sub> released in this way is then drawn off at the top of the tower. As the cooler at the head of the column causes the steam to condense, the CO<sub>2</sub> captured is fairly pure and can be subsequently compressed for transport. The CO<sub>2</sub>-lean solvent is then returned to the absorber tower via a heat exchanger, thus completing the solvent cycle.

Figure 8 does not show the compressor unit in which the CO<sub>2</sub> is compressed to a pressure of 100–120 bar. Compression is a multistage process with intercooling stages that ensure that any water vapour still present condenses out.

The water from the condenser and the intercooling units is fed back into the solvent cycle, which means that overall the water circulates in what is essentially a closed water cycle.

### **Design and operational factors**

Figure 83 shows the most important factors for the design, operation and optimisation of the CO<sub>2</sub> capture facility. These factors can be divided into the following groups:

- Plant data, such as the type and structure of the columns and how they are connected
- Basic data for the CO<sub>2</sub> separation facility, essentially covering important geometrical and flow dynamics information
- Thermodynamic data relating to the solvent and its heat treatment
- Kinetic data relating to the solvent.

A number of the key properties of the plants, processes and media used are identified and described below.

### **Temperatures and temperature profiles within the absorber column**

The reaction rates in the liquid phase and the position of the reaction equilibrium are affected by the temperatures of the flue gas and solvent streams

when they enter the absorber column. The regenerated (i.e. CO<sub>2</sub>-lean) solvent enters at the head of the absorber column with a temperature of about 40 °C. On the downward path to the base of the column, the concentration gradient drives the CO<sub>2</sub> from the gas phase into the liquid phase. As the CO<sub>2</sub> is absorbed by the solvent, most of the heat released by absorption is taken up by the solvent stream, whose temperature increases to about 70–80 °C depending on the enthalpy of absorption and the extent of CO<sub>2</sub> loading in the binary (amine-water) solution. At the base of the absorber tower, the CO<sub>2</sub>-rich solvent has a temperature of around 55 ± 5 °C. The temperature profile within the absorber tower is shown in Figure 84. The horizontal bars indicate the degree of absorption occurring within each vertical segment of the column. In order to mitigate the pronounced temperature rise in the central part of the column and thus make the absorption mass transport process more uniform across the height the tower, one or more intercooling units are incorporated (see Fig. 82).

Fig. 83: Factors used in designing and optimising the CO<sub>2</sub> capture process

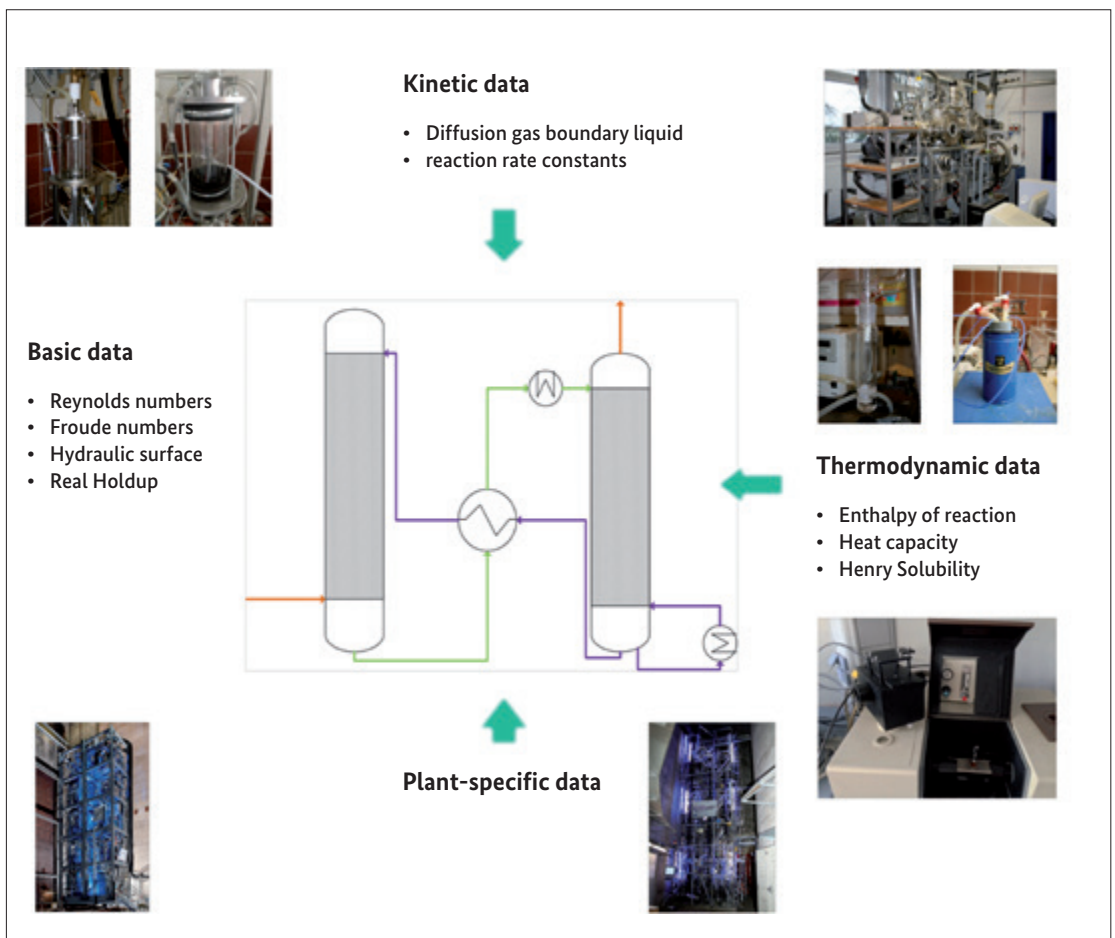

Process temperatures must be specified and set in such a way that the overall water balance in the system is maintained. Furthermore, the upper limit of the temperature range is determined by the drop in CO<sub>2</sub> loading with increasing temperature, while the lower limit is dictated by the slower reaction rate at lower temperatures.

**Temperatures in the desorber tower**

The maximum temperature that can be achieved in the **desorber** is determined by the pressure and the boiling points of the low-boiling components. To speed up solvent regeneration by increasing the rate of CO<sub>2</sub> desorption (stripping), the position of chemical equilibrium has to be shifted by increasing the temperature and pressure in the tower. However, increasing temperature and pressure causes greater levels of solvent degradation and corrosion. PCC processes involving aqueous amine solutions typically have desorber pressures in the range 1–3 bar and temperatures at the base of the desorber column of 120–135 °C.

Fig. 84: Temperature profile of the solvent stream in the absorber tower

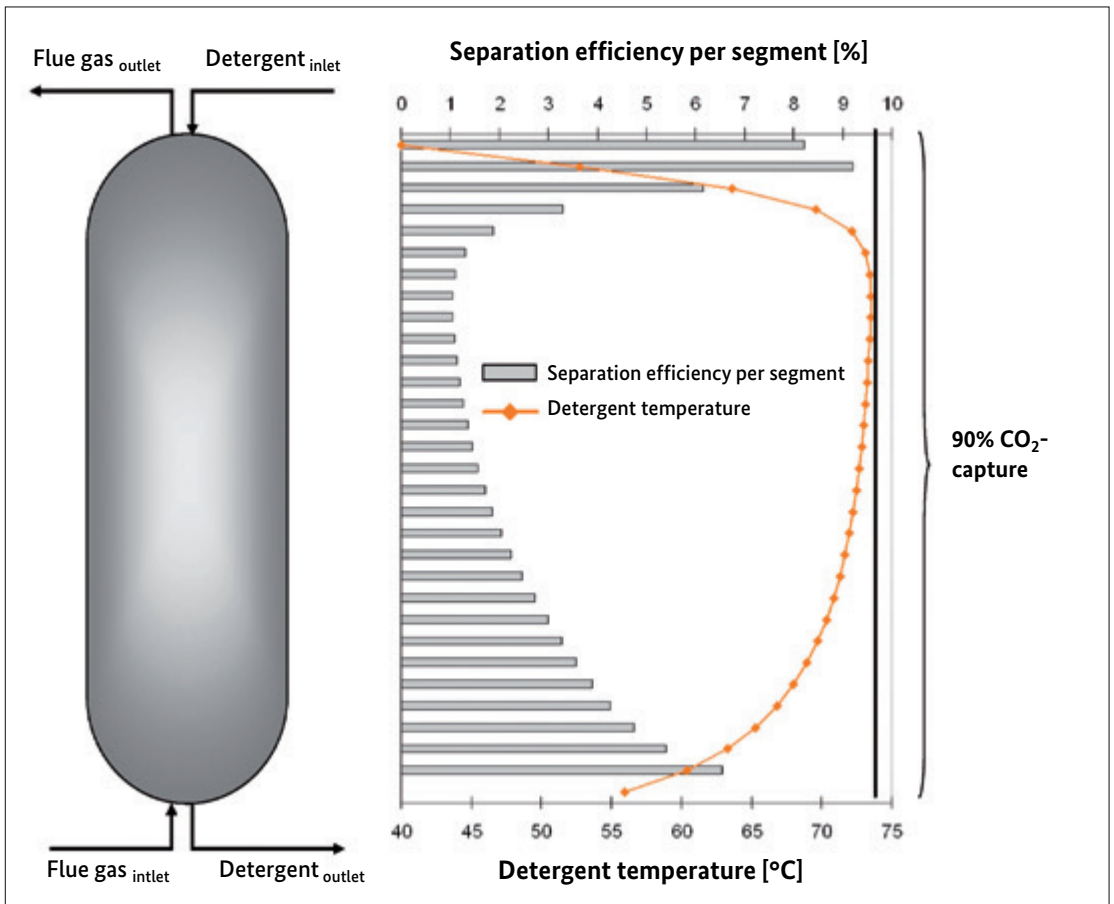

Depending on their vapour pressures, the amine absorbents will also be present in the flue gas stream at the head of the desorber. To prevent them being emitted from the tower, the head of the column is fitted with an additional scrubber unit. After passing through this final scrubber unit, the purity of the CO<sub>2</sub> stream is between 95% and 99.99% depending on process conditions.

### Solvent flow rate

The solvent flow rate plays a key role in carbon capture by chemical absorption while also being very simple to influence and optimise. It directly determines the energy consumption of the desorber reboiler, which increases with increasing mass flow. Mass balance considerations in the solvent stream also determine the difference in concentration between the 'lean loading' and the 'rich loading' states. For a constant degree of CO<sub>2</sub> absorption in the absorption tower, reducing the solvent flow rate in the desorber will result in greater desorption (stripping) of CO<sub>2</sub> and a leaner capture solvent leaving the desorber. For a given solvent, a constant CO<sub>2</sub> capture rate (usually assumed to be 90%) and otherwise constant process conditions, the solvent flow rate can be varied and the energy demand adjusted accordingly to find the energetic minimum.

There are numerous [additional parameters](#) that affect process performance, including:

- solvent stability and resistance to corrosion
- thermal degradation
- oxidative degradation
- reaction with inorganic and organic acids
- irreversible side reactions with CO<sub>2</sub>
- corrosion of plant equipment.

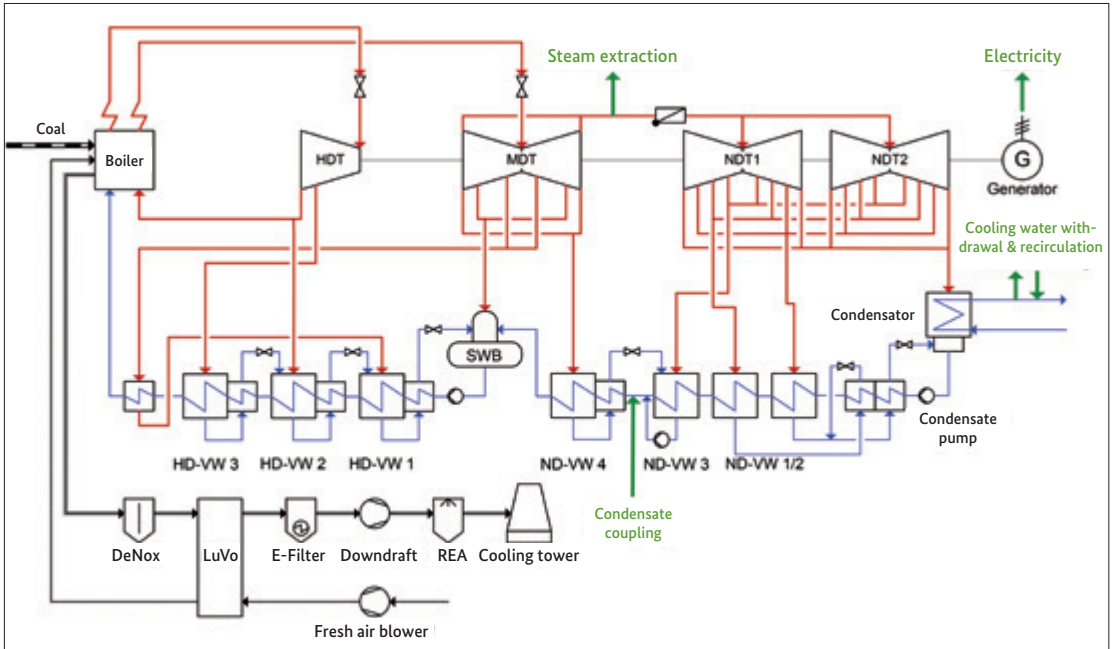

Fig. 85: Simplified diagram of a power generating plant, the interfaces with the CO<sub>2</sub> capture and CO<sub>2</sub> compression systems are shown by the green arrows

Table 4: The different types of energy used for the various process substeps [1]

Type of energy	Plant components	Function
Electrical energy	<ul style="list-style-type: none"> <li>Modified FGD</li> <li>Additional blower</li> <li>CO<sub>2</sub> absorption</li> <li>CO<sub>2</sub> compression</li> </ul>	<ul style="list-style-type: none"> <li>Reducing SO<sub>x</sub> fraction to below 10 ppm</li> <li>Compensating for the pressure drop in the absorber tower</li> <li>Solvent cycle</li> </ul>
Thermal energy (heat to be added)	<ul style="list-style-type: none"> <li>Reboiler</li> <li>Reclaimer</li> </ul>	<ul style="list-style-type: none"> <li>Solvent regeneration</li> <li>Heating and purifying the solvent</li> </ul>
Thermal energy (heat to be dissipated)	<ul style="list-style-type: none"> <li>Solvent cooler</li> <li>Intercoolers in the CO<sub>2</sub> compression step</li> </ul>	<ul style="list-style-type: none"> <li>Improving absorption and reducing the energy requirements for the additional blower</li> <li>Improving absorption</li> <li>Energy optimisation of the CO<sub>2</sub> compression step and water removal</li> </ul>



### 3.1.3.3 Integrating the carbon capture system into the overall power generation process

If a PCC system is to be integrated into a power plant, it has to be connected to the flue gas side of the power generation process. Steam also has to be provided to regenerate the solvent in the desorber. The steam is typically extracted from the bypass line between the intermediate-pressure (IP) and low-pressure (HP) sections of the steam turbine (see Fig. 85, 'Steam extraction'). As this steam is no longer available for electric power generation, the net power generation efficiency of the power plant is lowered. Electric power is also required to drive the pumps and fans in the capture process. The power is taken from the generator, reducing overall efficiency still further. To set the temperatures required in the carbon capture process, additional cooling from the cooling tower is required. However, as these three material and energy streams are strongly coupled to one another, they offer the opportunity to energetically optimise the overall process.

Table 4 shows the different types of energy used, the plant components that use each type of energy and the function of the respective components.

The integration of the PCC system into the power plant also offers a number of potential areas for optimisation, such as:

- Heat requirements of the CO<sub>2</sub> absorption and CO<sub>2</sub> compression stages
- Cooling requirements of the CO<sub>2</sub> absorption and CO<sub>2</sub> compression stages
- Integration of the CO<sub>2</sub> absorption and CO<sub>2</sub> compression stages into the power plant

For further information the reader is directed to the literature ([1]).

## 3.1.4 Summary

Carbon capture is a well developed technology, but one that still offers potential for optimisation in terms of energy consumption and therefore process costs.

Carbon capture has been used for many years in natural gas processing and in enhanced gas and oil recovery operations in a number of countries, such as Canada.

Any carbon capture process has to be adjusted to accommodate the specific

requirements of the main industrial process that is emitting CO<sub>2</sub>. Industrial processes of special interest in this regard are fossil fuel power plants and thermoprocessing equipment.

Combining captured CO<sub>2</sub> and electricity from renewable sources to manufacture gases, fuels and chemicals (CCU or P2X) is one possible approach to reducing CO<sub>2</sub> emissions from unavoidable sources.

Research programmes focused on the utilisation of CO<sub>2</sub> and the very visible commitment shown by numerous companies from the chemical industry underscore the need to continue refining and improving the carbon capture technologies discussed above.

Public acceptance of the idea of carbon storage is low in Germany. Globally, however, carbon storage represents a hugely important instrument in reducing greenhouse gas emissions.

Further research and development work into carbon capture technologies should therefore be encouraged and supported.

## Symbols and chemical abbreviations

$c$ [mol/m <sup>3</sup> ]	Concentration
$k$ [1/s]	Reaction rate constant
$t$ [s]	Time

DEA	Diethanolamine
DETA	Diethylamine
MEA	Monoethanolamine
MDEA	Methyldiethanolamine
EDA	Ethylenediamine
PZ	Piperazine

## References:

- [1] Fishedick, M.; Görner, K.; Thomeczek, M. (Hrsg.): CO<sub>2</sub>: Abtrennung, Speicherung, Nutzung. Springer-Verlag Berlin Heidelberg, 2015.
- [2] Stolten, D.; Scherer, V. (Eds.): Efficient Carbon Capture for Coal Fired Power Plants. Wiley-VCH Verlag, Weinheim, 2011.
- [3] Kuckshinrichs, W. et al.: Weltweite Innovationen bei der Entwicklung von CCS-Technologien und Möglichkeiten der Nutzung und des Recyclings von CO<sub>2</sub>. Schriftenreihe des Forschungszentrums Jülich Band 60, 2010.
- [4] Görner, K.: Technische Verbrennungssysteme – Grundlagen, Modellbildung und Simulation. Springer-Verlag Berlin Heidelberg, 1991.
- [5] Strauß, K.: Kraftwerkstechnik. Springer-Verlag Berlin Heidelberg, 1998.
- [6] Effenberger, H.: Dampferzeugung. Springer-Verlag Berlin Heidelberg, 2000.
- [7] Rebban, E.: Energiehandbuch. Springer-Verlag Berlin Heidelberg, 2002.

## 3.2 EffiCO<sub>2</sub> – New efficient carbon capture solvents

BMBF Project FKZ 033RC1003

Project Coordinator: Frank Hellmers, Evonik Creavis GmbH

Project Partner: Universität Erlangen-Nürnberg, Universität Duisburg-Essen

### 3.2.1 Introduction

In 2011, global annual anthropogenic CO<sub>2</sub> emissions from the use of fossil resources were around 34 Gt (German Federal Ministry for Economic Affairs and Energy (BMWi), 2013). Fossil fuels will continue to supply most of the world's energy requirements for the foreseeable future (BP, 2013). Meeting future energy demands while also reducing CO<sub>2</sub> emissions will require technologies that enable the efficient capture of CO<sub>2</sub> from industrial gases and flue gases. Major point sources of industrial gases and flue gases that contain CO<sub>2</sub> can be found in many sectors of industry, such as in chemical manufacturing, cement and limestone production, the power industry or in the iron and steel sector. Most industrial flue gases contain CO<sub>2</sub> in only low concentrations or in contaminated form. If this CO<sub>2</sub> is to be utilised rather than emitted into the environment, we need methods that can separate and purify the CO<sub>2</sub>. The carbon capture procedures currently available suffer from the serious economic disadvantages as they require large amounts of energy to regenerate the solvent (i.e. the absorbent) and because large quantities of solvent are required. There is therefore a need for substantially improved and significantly more efficient carbon capture solvents. Only then can carbon capture and utilisation schemes achieve the necessary levels of cost-efficiency.

In the collaborative project 'EffiCO<sub>2</sub>: New efficient carbon capture solvents', we have developed new CO<sub>2</sub> capture solvents and a more efficient overall approach to the carbon capture process. The aims are to apply this new technology to the widest possible range of industrial sectors (chemical industry, cement and limestone production, iron and steelmaking, power generation) and to bring the technology to market on conclusion of the publicly funded research project.

### 3.2.2 Project description

The goal of the collaborative project was to study novel, universally applicable solvents to identify improvements that would make solvent-based carbon capture technology less energy and resource intensive. The core objectives were:

- Improving the efficacy and the stability of the solvents
- Reducing the amounts of solvent used
- Reducing the energy needed to regenerate the solvent.

Promising candidate solvents from a variety of substance classes were specifically synthesised for study and further development. To achieve a wide but detailed evaluation of potential solvents, the substance classes studied included amines, amino acids and ionic liquids. An examination of the underlying chemical absorption mechanism enabled the development of specially tailored solvents by targeted chemical modification of candidate substances. Once particularly promising solvents had been identified, efficient synthetic routes were derived. The structures were then screened against exclusion criteria, such as toxicity, price and CO<sub>2</sub> loading capacity, and the most favourable candidates were then subjected to comprehensive experimental evaluation on the basis of the criteria set out in the technical requirements document. In order to study the action of the solvents in a real flue gas environment, a pilot carbon capture unit was installed at the base of the chimney in the Herne power plant in Germany. Process simulation techniques were used to model the entire process and to combine the results from the lab evaluation studies and from the experiments conducted with the pilot plant. The process model was then used to assess the cost-efficiency of the overall process. Factors included in the assessment were the expected process costs, the dimensions of the carbon capture apparatus and the associated capital investment costs. Finally, life cycle assessments were compiled for the most promising solvents.

### 3.2.3 Results

During the EffiCO<sub>2</sub> project, carbon capture solvents were developed and then tested in the laboratory in a real flue gas environment. The resulting solvents exhibited definite advantages compared with the solvents currently in use. By simulating the entire carbon capture process, the economic and environmental impact of using these solvents to absorb carbon dioxide in the power plant sector could be evaluated. This enabled information to be

gathered on structure-activity relationships across substance class boundaries and on the energy demands of CO<sub>2</sub> scrubbing operations.

In the course of the project, two particularly promising solvents were identified; one was an amino acid, the other an amine. These molecules were extensively characterised in order to quantify their chemical stability, CO<sub>2</sub> solubility, heat capacity, absorption enthalpy and their reaction kinetics. In addition, the CO<sub>2</sub> loading capacity was determined experimentally between two specified temperatures. Compared to current conventional carbon capture technology, which uses the amine MEA (monoethanolamine), the CO<sub>2</sub> loading capacity of the new solvents was improved significantly. Furthermore, a number of substances were identified that can act as kinetic promoters that significantly increase the absorption rate.



To study these newly developed solvents under more than just idealised laboratory conditions, an experimental plant was set up to facilitate testing in a realistic operational environment. The pilot carbon capture unit was installed at the base of the chimney at the Herne CHP plant (Figure 86).

The entire power plant process with end-of-pipe carbon capture system was modelled by exploiting the strengths of the simulation tools Aspen and EBSILON. This involved identifying interfaces and enabling communication between the two programs in order to optimally model the overall process.

Using the amino acid-based CO<sub>2</sub> solvent enables the electricity generation costs to be reduced by about 3% compared to using MEA as the solvent, despite the fact that investment

Fig. 86:  
The pilot carbon capture facility, which is installed at the base of the chimney in the Herne CHP plant, comprises a scrubber tower, an absorption column and a desorption column.

expenditure and variable costs for the new CO<sub>2</sub> solvent system are greater. These negative effects are more than compensated by the improved net efficiency of the plant (approximately 2 percentage points). This higher net efficiency results in a reduction of CO<sub>2</sub> emissions by around 120 kg CO<sub>2</sub> per t CO<sub>2</sub>.

### 3.2.4 Exploitation, commercialisation and dissemination of results

The novel CO<sub>2</sub> solvents developed in this project are protected by the following patents:

- ‘Process for absorbing CO<sub>2</sub> from a gas mixture’ DE102012200566 A1.
- ‘Process and absorption agent for absorbing CO<sub>2</sub> from a gas mixture’ DE102012200907 A1.
- ‘Absorption agent and process for absorbing CO<sub>2</sub> from a gas mixture’ DE102013010035 A1.
- ‘Process for absorbing CO<sub>2</sub> from a gas mixture’ DE102012222157 A1.

With the conclusion of the publicly funded project, the aim now is to bring these newly developed solvents to market. Target markets are not just the flue gas sector, but also the natural gas sector and a number of other branches of industry. However, further testing needs to be performed to optimise these solvents so that they meet the demands of specific industrial applications.

## 3.3 CO<sub>2</sub>-Kompressor – Developing a miniaturised, oil-free CO<sub>2</sub> compressor with an integrated CO<sub>2</sub>-cooled electric motor drive for large-scale CO<sub>2</sub> heat pumps

BMBF Project FKZ 033RC1014

Project Coordination: Dr. Gerd Janson, KSB AG

Project Partner: Universität Stuttgart, Hochschule Mannheim, Technische Universität Kaiserslautern

### 3.3.1 Project background

The European Heat Pump Association forecasts that 20% of the Europe's entire carbon emission reduction targets can be achieved through the use of heat pumps. The term 'heat pump market' typically refers to a market for small-scale heat pumps with thermal power ratings of up to 40 kW. The markets for larger industrial heat pumps (with thermal capacities greater than 40 kW) are far less well developed than those for smaller units. One gateway market of particular interest for CO<sub>2</sub> heat pumps is their use in water heating and space heating applications. Up until now, the use of CO<sub>2</sub> as a refrigerant in heat pumps has been hindered by the effect that the oil lubricant has on the thermodynamics of the refrigerant medium. The mixing of CO<sub>2</sub> and oil alters the properties of the CO<sub>2</sub> refrigerant medium and this has prevented the heat pump from achieving the desired coefficient of performance and has made the use CO<sub>2</sub> as a heat pump refrigerant less attractive. The advantage of CO<sub>2</sub> over the synthetic refrigerants currently used is that the global warming potential of CO<sub>2</sub> is some one to two thousand times smaller than that of the chlorine-free hydrofluorocarbons commonly used at present. Among the natural refrigerants available, CO<sub>2</sub> is the only one that is neither toxic (cf. ammonia) or flammable (cf. propane or butane). These are all reasons why natural refrigerants are only rarely used in heat pumps. For CO<sub>2</sub> heat pumps to succeed commercially, the technology needs access to efficient, oil-free, high-pressure compressors.

### 3.3.2 Project description

#### 3.3.2.1 Project objectives

The aim of this project was to develop, build and test a prototype of an oil-free CO<sub>2</sub> compressor with an integrated CO<sub>2</sub>-cooled motor drive for



use in electric CO<sub>2</sub> heat pumps. The prototype should be suitable for heat pumps with thermal power ratings of about 80 kW or more with the potential to be used in a broad range of applications (e.g. for water heating and space heating requirements in commercial facilities, such as accommodation complexes, laundries, public baths, etc.). Developing a new, miniaturised, oil-free CO<sub>2</sub>-compressor with an integrated, CO<sub>2</sub>-cooled electric motor drive should facilitate construction of the large-scale CO<sub>2</sub> heat pumps capable of exploiting the previously unused potential of low-temperature heat sources. Thanks to its excellent heat capacity and thermal conductivity, CO<sub>2</sub> is well-suited to function as the heat-transfer medium (often referred to simply as the ‘refrigerant’) within a large-scale heat pump. Creating a well-designed compression stage required advancing our understanding in technically unexplored domains relating to the drive system, rotor dynamics and the bearing systems and to the aerodynamic design of the miniaturised compressor components. The project focused on developing an efficient compressor that would not only make use of the greenhouse gas CO<sub>2</sub> as its heat-transfer medium, but whose mode of operation, environmental benefits and efficiency would make a significant contribution to exploiting the potential offered by low-temperature heat sources.

### 3.3.2.2 Project implementation: Suitability of CO<sub>2</sub>

The project objectives raised novel areas of scientific investigation. For example, at the beginning of the project it was not possible to perform accurate modelling of the pressure increase that accompanies the transition of CO<sub>2</sub> from its subcritical to supercritical state, especially when dealing with very small quantities of CO<sub>2</sub> in miniature turbocompressors with blade diameters of about 20 mm. There were also no oil-free bearing systems for gaseous media for this type of application and the operational constraints and the relevant boundary conditions had not been developed. At that time, there were also no viable engineering solutions for the high-speed electric drives or for the essential power electronics (including the appropriate instrumentation and control functionality) and these elements therefore also needed to be developed. The large volumetric heat capacity exhibited by CO<sub>2</sub> makes it a highly efficient heat-transfer medium for achieving the high-temperature heat generated in parts of the heat pump cycle. Its thermodynamic properties mean that it can deliver the sorts of high-temperature supply flows that are typically found in, for instance, the heating systems of older buildings. CO<sub>2</sub> is readily available, as it is produced in large quantities from the combustion of fossil fuels.

### 3.3.2.3 Project implementation: Energetic suitability

A transcritical process cycle is essential to achieving sufficiently high coefficients of performance in CO<sub>2</sub> heat pumps. The term ‘transcritical’ means the

transition from the supercritical to the subcritical state and vice versa. Heat transfer in a transcritical cycle does not take place at a constant temperature, as it does in conventional heat pumps, but on a sliding temperature scale at a constant pressure ('isobaric heat transfer').

### 3.3.2.4 Project implementation: Technical suitability / feasibility

If CO<sub>2</sub> is used as the heat-transfer medium in compression heat pumps, the final pressure in the compressor needs to rise to 80 bar or higher. In current heat pump systems operating with thermal ratings of 50 kW or more, pressures of this magnitude are achieved by means of reciprocating compressors or rotary-screw compressors. Both of these compressor technologies have the inherent disadvantage that they introduce oil into the refrigerant medium. As downstream oil filters and separators are unable to completely remove the oil, the result is a reduction in the coefficient of performance and a deterioration in the heat transfer within the evaporator and the condenser units due to the deposition of an oil film on the heat exchanger surfaces, which then has to be compensated for by increasing the surface area of the heat exchanger units. It is therefore desirable to work with compressors in which oil is not introduced into the refrigerant medium. One possible solution is to use a centrifugal compressor with rotors supported in gas (CO<sub>2</sub>) bearings. The target coefficient of performance of 4 in combination with installation space and cost restrictions and a target thermal rating of 80 kW leads to a high-speed multistage design concept with an encapsulated electric drive and very small rotor blade diameters (approx. 20 mm). At present, no such multistage CO<sub>2</sub> compressors with high-speed encapsulated electric drives are available commercially. The development work was carried out in the lower part of the dimensional spectrum, as this is the domain in which any deterioration in efficiency due to flow boundary layer and loss effects are at their most pronounced.

## 3.3.3 Project results

### Work Package 1: Development of a high-speed bearing and seal for the CO<sub>2</sub> compressor

The small CO<sub>2</sub> volumes flowing in the heat pump meant that the compressor needed to be miniaturised, which in turn dictated compressor speeds of up to 180,000 rpm. This necessitated the development of lubricated gas bearings that would work with the CO<sub>2</sub> flowing within the system. Up until now, most of what is known about gas bearings has been provided by empirical data. The proposed development work required devising a theoretical model that could describe the fundamental relationships between gas quantities, gas pressures and gas flow speeds in gas bearings.

**Work Package 2: The aerodynamic and hydrodynamic design of the CO<sub>2</sub> compressor**

Existing theories were unable to adequately describe the flow in the various compressor stages due to the dominance of the boundary layer effects in the miniature flow channels. Simulations were therefore required that would enable the characteristic compressor performance parameters to be analysed. It was also necessary to study the fundamental relationships relevant to the compression-induced transition from the aerodynamic (gaseous) state of CO<sub>2</sub> to the hydrodynamic (supercritical) state of CO<sub>2</sub> and to describe this using the model.

**Work Package 3: Modelling and experimental investigation of the mechanics, particularly the rotor dynamics and gas-dynamic-induced shear losses in the high-speed electric drive**

This work package involved modelling the dynamics of a rotor comprising a shaft supported on a gas bearing, an armature and more than one compressor stages. The rotor system had to be designed so that the critical rotational frequencies were far enough away from the compressor's potential operating points. The model developed in this work package was to be used as the basis for developing the rotor components (See Work Package 5). When the rotor operates at high speeds (> 100,000 rpm), the viscous drag of the armature as it rotates in the surrounding gas results in frictional losses and attendant pressure drops. In the case of a gaseous medium, these losses are referred to as aerodynamic losses. The simulation experiments were designed to generate dynamic models and parameter values that were suitable for comparison with the existing theories. The aim was to verify and/or confirm these theories so that they could be used in Work Package 5 to minimise the shear losses within the motor.

**Work Package 4: Basic research for the development of a high-speed electric drive system**

In order to be able to access all of the compressor's required operational states, the motor for the miniaturised CO<sub>2</sub> compressor has to be operated in the approximate speed range 80,000–180,000 rpm. This required the development of a suitably configured solid-state controller. The aim was to achieve an almost constant torque across the entire speed range. In that case, the power is approximately proportional to motor speed. Key sources of power loss within a motor are the copper losses in the copper windings of the stator and the iron (or core) losses in the motor. The aim of the simulations was therefore to determine these individual losses at the drive's control frequency in order to identify any fundamental relations between hysteresis losses and eddy current losses and frequencies in the kilohertz range. Additional simulations were carried out at the control frequency aimed at investigating any relationships between high-frequency excitation and attenuation and including the results in the modelling of the system.

**Work Package 5: Development and testing of key components and subsystems**

To test system functionality and compatibility, the following combinations of subsystems were examined: electric drive and gas bearing; electric drive and shear force reduction sleeve; electric drive and gas bearing and single stage of compressor; power electronics for power supply, measurement and control functions.

**Work Package 6: Development, construction and testing of a prototype**

The results accumulated over the development period for the individual system components were then brought together by building a working prototype (function model) of the entire system. When installed in the overall system, the individual components necessarily interacted with one another (e.g. through vibrational excitation). Tests were then carried out on the prototype CO<sub>2</sub> compressor to determine whether the requirements regarding buildability, overall functionality and performance data (pressure, temperature and efficiency) were met. The production and fabrication of the working prototype was conceived so that each step of the process could be individually assessed and documented. This was necessary as there was no established body of knowledge regarding such aspects as constructability and fabrication for the type of miniaturised machines being studied here (heat pumps with electric power ratings of up to 50 kW and thermal power ratings of up to 200 kW). It was also important to ensure that all faults and errors during the development phase were identified as such and that the function model was reproducible.

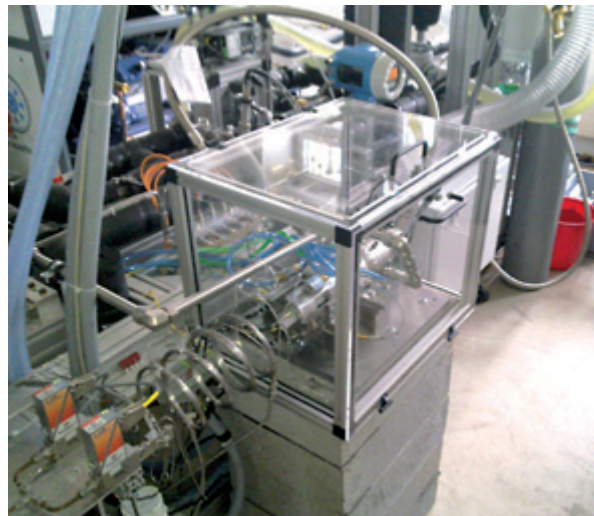

Fig. 87:  
Prototype undergoing  
lab testing

### 3.3.4 Exploitation, commercialisation and dissemination of results

#### 3.3.4.1 Economic prospects

The knowledge that has been gained from the project cannot be utilised economically at present, as the individual technological developments are not yet ready for the market. Potential applications of the results obtained include gas bearings, turbo generators, and high-speed electric drive applications. The time horizon is five years; additional technology transfer projects are needed.

#### 3.3.4.2 Scientific and research prospects

As part of the research project, numerous aspects of existing theories were analysed, supplemented and experimentally tested. The improved theoretical understanding of frictional losses at high rotational speeds can be directly applied in other research projects. The deviations observed between the calculations and experiments performed in the course of the present project and those predicted by existing theories have cast fundamental doubt on some of the existing empirical values quoted for similar fluid dynamic environments. Further research is required. Similar flow scenarios are known to exist in other areas, such as flywheel storage systems, pumps and turbines, whose behaviour is typically described by adopting commonly accepted assumptions. The results acquired during this collaborative project now enable these assumptions to be systematically questioned and tested. The results from the individual subprojects will be made available by the university research teams in future publications in the scientific literature. A number of results, such as those concerning rotor design and the drive unit are the subject of ongoing research work within the HDTG project (High-speed Turboexpander Generator), which is part of the ATEM programme, where the results are being adapted to other areas of application. (Project partners: KSB AG, TTI Turbo Technik GmbH, Ruhr-University Bochum, Kaiserslautern University of Technology)

## 3.4 InnovA<sup>2</sup> – Innovative plant equipment concepts for increasing the efficiency of production processes

BMBF Project FKZ 033RC1013

Project Coordinator: Prof. Dr. Stephan Scholl, TU Braunschweig

Project Partner: Universität Kassel, Helmut-Schmidt-Universität – Universität der Bundeswehr Hamburg, Technische Universität München, Universität Paderborn, Bayer Technology Services GmbH, DEG Engineering GmbH, Evonik Industries AG, LANXESS Deutschland GmbH, Linde, Merck, Wieland-Werke Aktiengesellschaft

### 3.4.1 Introduction

Increasing the energy efficiency of production processes in the process industry is a significant step towards achieving the German government's climate targets. Heat integration is a proven method of combining the heat requirements of a process with the heat sources available to that process and so reducing the primary energy needs of the process. This also reduces the quantities of resources and operating materials needed for both the hot and cold streams. If a proposed heat integration measure is to succeed, it must:

- be technically feasible for the specific plant or equipment
- function reliably in all of the required operational and load states and
- be economically beneficial.

The feasibility of a proposed heat integration scheme is often limited by the available temperature difference between the hot and cold process streams, i.e. between the heat source and the heat sink. Modern heat integration systems have to be designed to enable the consistent transfer of heat even at small temperature differentials. This can be achieved particularly effectively when vaporisation or condensation processes are involved, as these phase

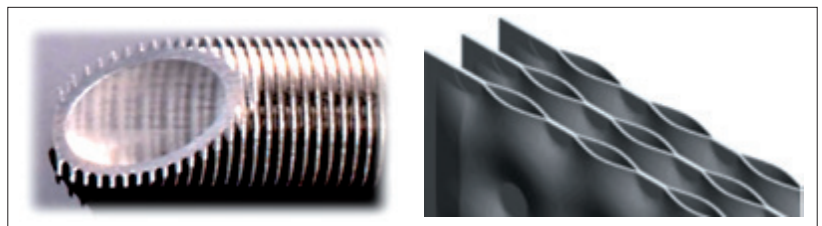

Fig. 88:  
Left: finned tubes  
(Wieland AG);  
Right: pillow plates  
(DEG Engineering GmbH)

transitions are accompanied by large heat flows at (approximately) constant temperature. The equipment and plant subsystems used in heat integration schemes need to operate particularly reliably, as they fulfil two functions simultaneously: withdrawing heat from the hot stream and delivering heat to the cold stream. In addition, the equipment used has to be competitively priced in terms of both initial investment and operating costs. Companies operating production facilities therefore tend to be somewhat cautious about introducing new equipment designs if these are untested or have been insufficiently tested, as this poses potential technological risks for two process functions.

Innovative equipment designs with the potential to meet the heat exchange characteristics described above, i.e. stable heat transfer driven at small temperature differences, are now commercially available, but as these designs are relatively new, there are correspondingly few reference applications, if any, currently available. This lack of reference applications and the absence of publicly available guidance on designing and dimensioning such systems has made it harder for this innovative technology to gain access to the relevant markets. Two such innovative heat exchanger designs, operating both as evaporators and condensers, were studied in detail in the collaborative project InnovA<sup>2</sup>. The two designs, finned tubes and pillow plates, are illustrated in Figure 88. The project also examined the concept of a multi-stream condenser for separate heat withdrawal, condensation and subcooling of a vapour stream. Multi-stream condensers offer exergetically efficient condensation through careful control of the temperature of the coolant.

Finned tubing is used in numerous HVAC applications, but is nearly always made from copper or a corresponding alloy. Most equipment in the process industry, however, is manufactured from carbon steel or stainless steel. When the InnovA<sup>2</sup> project began, the publicly accessible scientific literature contained neither performance data nor design principles for these components when manufactured from steel. The same applied to the use of pillow plate devices as natural circulation evaporators, also known as natural convection evaporators. Natural circulation evaporators are particularly cost-effective, as they combine low specific investment costs [€/m<sup>2</sup>] with minimal operating costs. There was some published work on modelling pillow plate devices as condensers, but this work was based on a very restricted set of data.

### 3.4.2 Project description

The objectives of the InnovA<sup>2</sup> project regarding innovative heat exchanger designs are set out below:



- Examine the heat transfer behaviour of different heat transfer media under a range of operating conditions
- Use the results of the initial surveys to develop empirically grounded computational approaches aimed at guiding the design and configuration of heat exchangers for heat integration applications
- Develop methods and models to assess the potential increase in the energy efficiency of the process when a particular type of heat exchanger is deployed
- Establish methods for assessing the economic and environmental impact of processes and process variants when using particular designs of heat exchanger equipment.

Achieving these objectives required careful coordination of experimental and theoretical work. Laboratory testing was conducted by the five academic research partners on lab-scale plants and was aimed at experimentally characterising and assessing the performance of the five types of heat exchangers being studied. Testing was performed on simplified equipment configurations (single tubes, tube bundles, single plate, plate pack) and using a specified set of heat-transfer media. A uniform approach was also agreed regarding the following aspects of the experimental work: acquisition of the raw experimental data; material and energy balance calculations; fluid dynamic and thermodynamic evaluation of data and data compression; establishing performance indices to facilitate performance evaluation of the types of heat exchanger studied. The aim was to ensure that the design types under test could be effectively compared with the conventional heat exchanger devices in current use, specifically, heat exchangers constructed from smooth cylindrical tubes of carbon steel or stainless steel.



Fig. 89:  
The research principles underlying the Innova<sup>2</sup> project.



These lab studies identified potentially advantageous applications and areas of use and the results were repackaged in the form of decision-making guidance.

Transferring the lab results and checking their suitability for use in industrial-scale facilities requires the dual-path strategy depicted in Fig. 89. One path involves geometric scale-up in which experimental testing is carried out on larger scale pilot plants, the other involves transitioning to the heat transfer media typically used in industrial plants. The scale-up involved a transition of about one order of magnitude from a thermal power rating in the 10–30 kW range and a heat transfer surface area of about 1 m<sup>2</sup> in the lab to a power rating of 100–300 kW range and a surface area of about 10 m<sup>2</sup> in the pilot plant studies. The vaporisation and condensation trials using finned tubes took place in the technical centre operated by Linde Engineering in Höllriegelskreuth, the experiments involving pillow plate evaporators and condensers were done in the technical centre at Bayer Technology Services GmbH in Leverkusen.

By experimentally characterising the performance of these new heat exchanger designs and by evaluating them relative to a conventional heat exchanger constructed from smooth cylindrical tubes, the project team was able to assess the equipment and process designs from both an economic and an environmental perspective. To assess the environmental impact of energy and material transfer processes, a new type of three-level model was developed. This allows the structured and modular mapping of an industrial process and how it is embedded within the surrounding operational, energetic and utility supply infrastructure.

Fig. 90: Structure of the collaborative project, showing the project areas (PA) and the associated subprojects

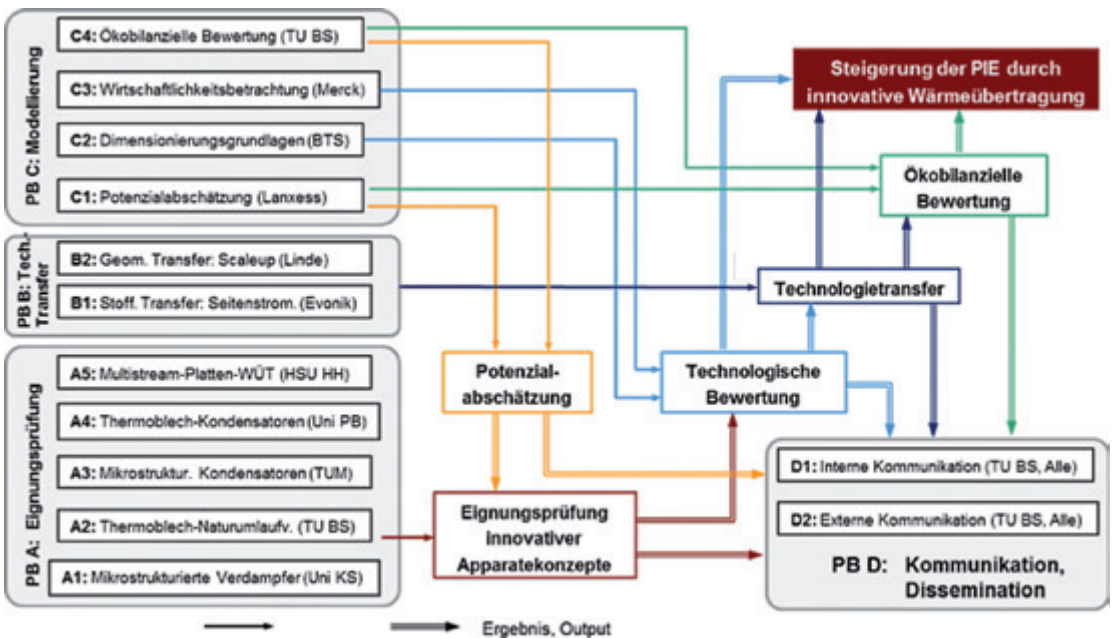

In order to achieve the project objectives, the Innova<sup>2</sup> collaborative project was split into four project areas each with up to five subprojects, see Fig. 90. The interfaces between the individual project areas, subprojects and work packages are also shown.

### 3.4.3 Results

The experiments performed on the different types of heat exchanger equipment yielded an extensive and publicly accessible database that allows fluid dynamic and thermodynamic performance assessments to be made. The objective was to provide guidance on designing and dimensioning such devices, so that users, especially those in the process industry, could make comparisons with the standard reference system that uses cylindrical smooth tubes. It is particularly noteworthy that the data from all of the experiments was determined using the same uniform, transparent and documented method. This made it necessary, for example, to specify exactly how to calculate the surface area of a finned tube or pillow plate heat exchanger.

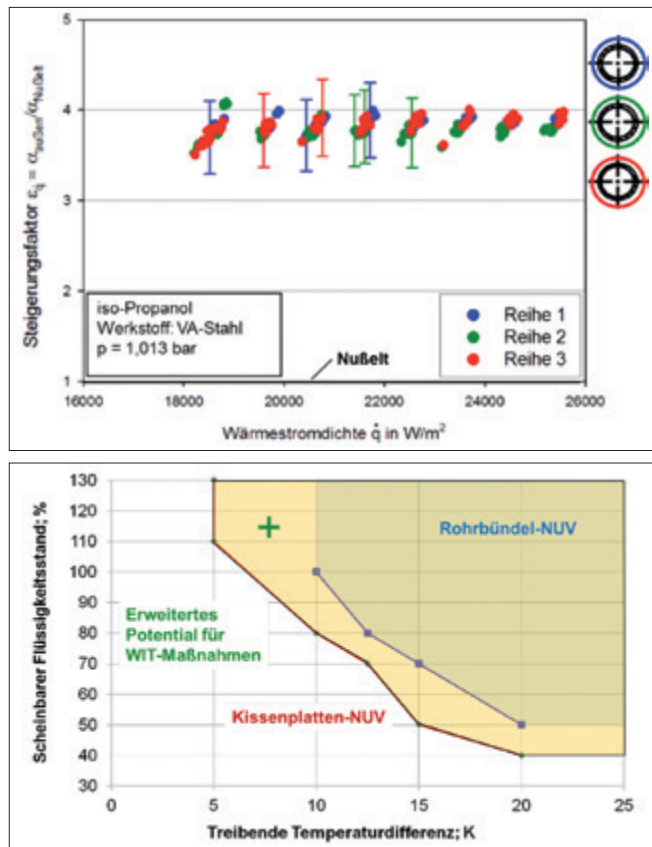

Fig. 91: Sample results from the Innova<sup>2</sup> project. Above: Increased heat transfer on finned tubes compared with smooth tubes.; Below: Operating windows for pillow-plate and tube-bundle natural circulation evaporators for water at  $p_{\text{abs}} = 200 \text{ mbar}$

Figure 91 provides examples of the sort of experimental data acquired. It shows on the left the condensation of isopropanol on three stacked finned tubes made from stainless steel; on the right it depicts the operational behaviour of a natural circulation evaporator made from pillow plates. In the left-hand panel, one sees the increase in the heat transfer coefficient for condensation on the finned tubes relative to the value calculated on the basis of Nusselt's theory for the equivalent smooth tube device. The finned tubes result in a heat transfer coefficient some 3.5 to 4 times greater than that achievable with a conventional heat exchanger tubes. It is also apparent that the heat transfer coefficient decreases on moving from the first (uppermost) row in the stack to the third (lowest) row. This observed decrease in heat transfer is known as the inundation effect, but it is significantly less pronounced than would be seen in an equivalent bank of smooth tubes. The reason for this is the improved drainage of the condensate from the fins compared with drainage from a smooth surface. The condensate dripping down from the upper tube drains away more rapidly, causing only a minor increase, if any, in the thickness of the condensate layer on the tube below.

The right-hand panel in Figure 91 presents a comparison of the operating window for a natural circulation evaporator using pillow plates and one for a standard smooth tube bundle evaporator for water at  $p_{\text{abs}} = 200$  mbar. Characteristic operating parameters include the apparent liquid level, i.e. the liquid level in the associated vapour condenser relative to tube length or plate height, and the temperature differential that drives heat transfer between the heating side and the condensing side. In heat integration schemes, the magnitude of the temperature difference is determined by the process. The effectiveness of a heat integration scheme is higher the smaller the temperature difference required between the heat-releasing side (the heat source) and the heat-receiving side (the sink). As can be seen in Figure 91, the entire operating window for the pillow plate device is significantly larger than that for the tube bundle. At high apparent liquid levels, the required driving temperature difference in the pillow plate device is only about 60% of that in the tube bundle. This means that heat integration initiatives become feasible at driving temperature differences that would be too small if conventional tube bundle equipment were to be used. Similar results were found in the studies of evaporation on finned tubes, condensation in pillow plate condensers and for the multi-stream plate condenser.

The computational approaches derived from the experimental data follow the established concept of using performance indices to facilitate calculation of the heat transfer coefficients for the different heat exchanger designs. It was also demonstrated that by suitable transformation, a pillow-plate or finned tube device can be reduced to an equivalent configuration involving cylindrical smooth tubes, which allows the computational methods men-

tioned above to be incorporated in the common commercially available simulation programs for heat exchangers.

### 3.4.4 Exploitation, commercialisation and dissemination of results

The project results can be used by different stakeholders working in the heat exchanger sector or in plant and process design. Companies that operate production processes in which this kind of technology is used can identify potential heat integration applications and carry out comparative assessments of the technological suitability and economic advantages that these new innovative designs offer compared to conventional smooth tube configurations. As a result of the project, the temperature differentials needed to drive heat integration schemes have been reduced, which has opened up opportunities to boost the energy efficiency of processes in a way that was not possible previously. The results generated by the project mean that guidance is now available for anyone interested in dimensioning evaporators, reboilers or condensers constructed using finned tubes or pillow plates. These calculations can then be used as the basis for an economic feasibility assessment of a potential heat integration scheme. Similarly, engineering consultants that design heat exchangers or who offer conceptual process engineering services can include these calculations in their service portfolios. They will then be in a position to identify and evaluate new opportunities to deploy heat integration measures and, if the initial outlook is promising, to dimension and configure the required plant equipment. The final decisions on engineering design and dimensioning will however remain with the companies who manufacture and supply this type of heat exchanger technology. Finally, equipment manufacturers and plant construction companies now have access to a reliable database that can support them when marketing these innovative equipment designs for new applications. They can also use the database for further applied research and development work, such as optimising the geometry of their own products. Optimising the geometry of finned tube and pillow plate systems can, for example, lead to improved thermal hydraulic efficiency, i.e. to increased heat transfer for a constant pressure loss or for a disproportionately small increase in pressure loss. However, these aspects were specifically not addressed in the InnovA2 project to maintain the precompetitive nature of the project. And lastly, the results achieved in InnovA<sup>2</sup> represent a new knowledge base in this field of technology, which academic and industrial R&D departments and institutions can now build upon. The work carried out and the results achieved in the InnovA<sup>2</sup> project were published in a special issue of the journal *Chemie Ingenieur Technik* entitled 'Innovative Apparate zur Effizienzsteigerung' ('Innovative Plant Equipment for Improving Efficiency') in March 2015. Further information is also available at [www.innova2.de](http://www.innova2.de).

## 3.5 Abwärme – Using low-temperature waste heat to drive absorption refrigerators and absorption heat transformers – Novel refrigerant-absorbent pairs

BMBF Project FKZ 033RC1017

Project Coordinator: Nina Merkel, KIT

Project Partner: Karlsruher Institut für Technologie (KIT), Institut für Technische Thermodynamik und Kältetechnik (ITTK), BASF SE; API Schmidt-Bretten GmbH, Ionic Liquids Technologies GmbH (IoLiTec)

### 3.5.1 Introduction

Industrial waste heat streams with temperatures in the range 80–120 °C are typically unused and simply dissipate their energy to the environment, but these streams of low-grade heat offer significant potential for reducing primary energy consumption. In this project, work was carried out to examine the use of waste heat to drive absorption cycles involving novel pairs of working fluids, particularly those with ionic liquids. The absorption cycles used in these studies were those found in absorption chillers (ACs), also known as absorption refrigeration devices and in absorption heat transformers (AHTs). The focus was on the waste heat streams with a useful heat flow above 10 MW that are typically found in many branches of industry.

Heat transformation is the process by which the temperature of a portion of the available waste heat (30–40%) is increased without any appreciable consumption of additional primary energy (or exergy) thus enabling, for instance, steam to be generated, which is then either fed into an existing steam network or used directly in a suitable production process. Although heat transformation has been recognised for some time as a thermodynamically attractive means of saving energy [1, 2], up until now only a few industrial-scale systems have been built. There are two main reasons for this: Most of the plants built in the 1980s with power ratings in the range 50 kW to 11 MW were not economically viable enough under the energy market conditions prevailing at that time. The refrigerant-absorbent pair LiBr–H<sub>2</sub>O, which was used almost exclusively at the time, caused corrosion damage and led to substantial operational problems. Other pairs of working fluids have so far failed to become established [3].

Absorption chillers (ACs) consist of the same components as heat transformers, but work at lower temperature levels. High-temperature waste heat is fed into the system in order to generate process cooling. There are already a number of systems available with power ratings in the range 10 kW to 1 MW that are mostly used for air-conditioning in buildings [4]. Despite these applications, the technology is still far from well established in the market. In addition, these air-conditioning systems also operate almost exclusively with the refrigerant-absorbent pair LiBr-H<sub>2</sub>O, and the associated corrosion problems can only really be alleviated by the addition of toxic corrosion inhibitors.

However, the international climate conference agreements on reducing CO<sub>2</sub> emissions has given rise to a new situation that could well lead to a renaissance in absorption cycle technology. Research carried out a few years ago produced a number of alternative absorbent-refrigerant pairs in which the absorbents were ionic liquids [5]. The suitability in principle of these novel pairs of working fluids for use in absorption cycles was demonstrated experimentally shortly before the present project began [6]. At room temperature, ionic liquids are liquid salts without any appreciable vapour pressure and whose properties can be varied over a wide range simply by the choice of cation and anion. With regard to operational safety, reliability and cost-efficiency, ionic liquids are opening up new perspectives in the field of heat transfer technology.

### 3.5.2 Project description

The overall goal of this collaborative project was to develop energy-efficient absorption cycles with power ratings of 10 MW or greater by using novel refrigerant-absorbent pairs to transform waste heat into heat at a higher temperature that can then be usefully exploited. Although not originally planned, the main focus of the study was on absorption heat transformers and less on absorption chillers, as at the beginning of the project there was no published work on the use of ionic-liquid-based alternative refrigerant-absorbent pairs in absorption heat transformers. The aim was to identify suitable pairs of working fluids for use in systems with operating temperatures up to 160 °C, to characterise their thermophysical properties and to subject them to laboratory testing. One of the main areas of focus during the project was on developing new equipment design concepts that are compatible with the new refrigerant-absorbent pairs and are suitable for transferring large quantities of heat. Finally, the project sought to set out some of the important principles underlying the design and dimensioning of heat transformers and to provide an example of an overall assessment of a typical system. The project involved a very broad range of studies that were carried out in close collaboration between the project partners.

### Selecting suitable ionic liquids

IoLiTec selected and synthesised suitable candidate ionic liquids (ILs) from a database containing more than 2000 ILs. A range of hygroscopic ILs were already known from previous work, but these were barely able to meet the required thermal stability criterion. The initial longlist of ILs was reduced to a final shortlist of six that was examined to determine the thermophysical property data relevant to heat transformation applications.

### Property data testing

Comprehensive studies of the six ILs were undertaken at ITTK. This involved searching the literature for relevant property data, though much of the required data was measured experimentally using existing equipment and the results described by means of correlation equations. Values were determined for the following properties: vapour pressures of aqueous mixtures, densities, specific heat capacities, excess enthalpies, viscosities, temperature stability and, in certain cases, diffusion coefficients. The key criteria that established the suitability of a candidate IL for its use in absorption heat transformers were shown to be phase equilibrium and temperature stability. On the basis of these criteria, the following two ILs were identified as suitable for use in a AHT: [EMIM][OMs] and [E3MPy][OMs].

### Process simulation

To enable dimensioning of the process and to allow comparisons to be made between different pairs of working fluids, a number of simulation programs were developed using MATLAB. A simple equilibrium stage model enabled the coefficient of performance (COP) to be calculated as a function of the temperature of the useful heat at different operating conditions. The COP is the ratio of useful high-temperature heat to the lower temperature waste heat input. Another equilibrium stage model was used to simulate two-stage processes. A program based on modelling mass and heat transfer processes was also developed to assist in the dimensioning of plate absorbers. Additionally, an alternative absorber concept comprising packed columns with intermediate cooling stages was simulated and studied.

### New equipment concepts

Up until now, the generator and absorber stages used in existing heat transfer systems and in commercially available absorption chillers have been configured as horizontal tube bundles. The weakness of such a design is the need for a uniform distribution of the fluid to ensure that the tubes remain completely wetted, something that is particularly hard to achieve when the working fluids are more viscous, as is the case with ionic liquids. To address this issue, API Schmidt-Bretten collaborated with ITTK to develop a novel type of plate absorber whose characteristic feature was a new distribution of



the working fluids. A patent has been filed for this new equipment design. A prototype has been installed in the new pilot plant at ITTK.

#### **Heat transformer pilot plant**

A pilot plant with a useful heat flow of 4 kW was set up at KIT together with the necessary peripheral equipment and was tested over an extended period of time. The absorber, desorber, evaporator, condenser and solvent heat-exchanger are all configured as plate heat exchangers. The measurement data was evaluated and plotted using a LabView-based analysis program. The plant was operated with the working fluids water and [EMIM][OMs]. The temperature of the waste heat input stream was 95 °C, the temperature of the cooling water was 25 °C. The maximum temperature of the useful heat output achieved under these conditions was 135 °C. It was, however, not possible to conduct a detailed assessment of the performance of the new plate absorber as the pilot plant only allowed for variation of the mass and heat flows over a limited range.

#### **Experimental facility to examine the absorption and desorption stages in a falling film column**

Falling film columns with vertical tubes are well-established components in the field of process engineering. They are particularly useful when dealing with large mass-throughput systems. It therefore seemed worthwhile to examine a falling-film column as a possible alternative to the plate configurations used for the absorber and desorber stages. An experimental test facility was set up at a BASF technical centre and was operated with the working fluid pairs water-[DEMA][OMs] and water-[EMIM][OMs]. Priority was given to measuring the absorption process, as the absorber contributes significantly more to overall cost. The measurement data was used to calculate thermal insulance values (also known as heat transfer resistance or thermal resistance) at a range of operating conditions.

#### **Economic feasibility**

Analysing the economic feasibility of the set-up based upon this one specific waste heat stream generated by a test plant at BASF proved challenging, as the particular circumstances and constraints applying in this one case study make it questionable whether the results could be generalised in a meaningful way. The economic feasibility study conducted by BASF was therefore not based on a specific case study, but was conducted for a generic application within the chemical and allied industries. The analysis was based on the following assumptions:

- The waste heat is generated isothermally (with no initial information regarding thermal power or temperature).



- The useful heat generated is then subjected to external superheating and fed into a low-pressure steam network (4 bar(g), i.e. 4 bar above ambient).
- The residual heat is rejected to a cooling water system (river water).

The plant equipment and instrumentation were dimensioned using the results from the project work described above.

**Environmental issues**

In the interests of cost-efficiency and sustainability it makes sense to regenerate the ionic liquids when they begin to show a drop in performance. To this end IoLiTec developed a procedure using the ionic liquid [DEMA][OMs] in which the IL is regenerated by drying and adsorption on activated carbon.

**3.5.3 Results**

Heat transfer systems can only be designed and dimensioned for use with novel binary mixtures of water and ionic liquids if the thermophysical property data relating to these working fluids is known. This data has now been compiled and published [7, 8, 9] and is available in the form of tables, diagrams and correlation equations.

The process optimisation studies showed that the absorber and desorber stages are best designed as plate heat exchangers or as falling-film configurations with vertical tubes as these designs are best able to deliver high heat transfer rates.

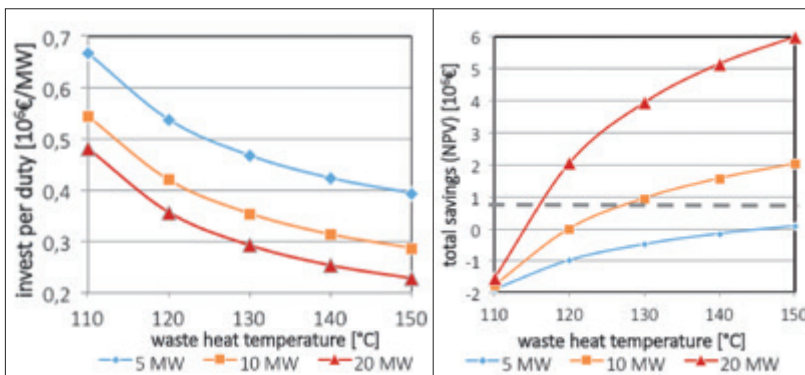

Fig.92: Investment costs per MW at different waste heat temperatures and heat flows

Fig.93: Total cost savings (investment + operating costs) at different waste heat temperatures and heat flows

It was shown for the first time that a heat transformer can be operated using a working fluid pair consisting of water and an ionic liquid ([EMIM][OMs]). The maximum temperature rise achieved was 40 K. The COP values measured were between 0.2 and 0.3. The simulation generated COP values of between 0.4 and 0.5, although these were calculated under ideal heat transfer conditions.

Figures 92 and 93 show the results from the economic feasibility analysis. Under the conditions specified in Section 2 above and assuming an input waste heat stream of 20 MW, an overall cost saving is only achievable if the waste heat stream has a temperature of 115 °C.

### 3.5.4 Exploitation, commercialisation and dissemination of results

The results indicate that if the useful heat from a heat transformer is to be fed into a low-pressure steam network, this will only be economical for large capacity systems and where the waste heat temperatures are higher than that originally proposed. It therefore seems unlikely that there will be any breakthrough for heat transfer technology in the near future. Over the medium- to long-term, however, increasing energy prices and further improvements in plate-based film heat transfer technology for absorber (and possibly desorber) units may lead to a significant shift in the position of the break-even point. The search for suitable pairs of working fluids resulted in the creation of a comprehensive database of comparatively thermally stable, hygroscopic ionic liquids, that could well open doors to a number of other applications, such as industrial drying processes.

The project results have been published in scientific journals and presented at scientific conferences. Two patent applications have been filed. A number of student research projects that addressed certain specific questions were completed within the project framework. This helped to raise awareness and generate interest among students for this type of approach to reducing energy consumption. The heat transformer at ITTK will be used for future student projects and will continue to be optimised as a result.

The collaborative interaction between the project partners also gave rise to a number of questions that went beyond the immediate scope of the project, such as developing and improving plate absorbers so that they can be used in absorption chillers. This and other questions could be usefully addressed in future collaborative projects.

**References:**

- [1] Altenkirch, E.: Techn. Phys. 1 (1920) Nr.1, 77-85; Nr.5, 93-101.
- [2] Stephan, K.: Der Wärmetransformator – Grundlagen und Anwendungen. Chem.-Ing.-Tech. 60 (1988) 335-348.
- [3] Genssle, A., O.: Wärmetransformation mit dem Arbeitsstoffpaar Trifluorethanol-Tetraethylenglykoldimethylether. Fortschritt-Berichte VDI, Reihe 19, Nr. 130, 1999.
- [4] Kühn, A., Ziegler, F.: Betrieb einer 10kW Absorptionskälteanlage als Wärmepumpe. KI Kälte Luft Klimatechnik, 3 (2009) 30 – 33.
- [5] Bösmann, A., Schubert, T. J. S. (Erfinder): Neue Absorptionsmedien für Absorptionswärmepumpen, Absorptionskältemaschinen und Wärmetransformatoren. Offenlegungsschrift DE 10 2004 024 967 A1, 2005.12.08 und WO 2005/ 113702 A1.
- [6] Römich, Ch., Schaber, K., Berndt, J., Schubert, T.J.S.: Arbeitsstoffgemische mit ionischen Flüssigkeiten für Absorptionswärmepumpen und Absorptionskältemaschinen. Abschlussbericht DBU AZ 22979, 2009. ( [http://www.dbu.de/projekt\\_22979/01\\_db\\_799.html](http://www.dbu.de/projekt_22979/01_db_799.html))
- [7] Merkel, N.C., Römich, C., Bernewitz, R., Künemund, H., Gleiß, M., Sauer, S., Schubert, T.J.S., Guthausen, G., Schaber, K.: Thermophysical properties of the binary mixture of water + [DEMA][Otf] and the ternary mixture of water + [DEMA][OTf] + [DEMA][Oms]. J. Chem. Eng. Data 59 (2014) 560 – 570.
- [8] Merkel, N.C., Weber, C., Faust, M., Schaber, K.: Influence of anion and cation on the vapor pressure of binary mixtures of water + ionic liquid and the thermal stability of the ionic liquid. Fluid Phase Equilibria, 394 (2015) 29 – 37.
- [9] Merkel, N.C.: Absorptionswärmereformation unter Verwendung ionischer Flüssigkeiten als Absorbentien. Dissertation KIT, Verlag Dr. Hut, 2016.

## 3.6 EP-Wüt – Energy-efficient heat exchangers

BMBF Project FKZ 033RC1003

Project Coordinator: Dipl.-Ing. D. Laaber<sup>1</sup>, Prof. Dipl.-Ing. Dr. techn. H.-J. Bart<sup>2</sup>; <sup>1</sup> Institut für Solarforschung, DLR, Jülich; <sup>2</sup> Lehrstuhl für Thermische Verfahrenstechnik, TU Kaiserslautern  
Project Partner: MERCK KGaA, Calorplast Wärmetechnik GmbH

### 3.6.1 Introduction

Heat exchangers are typically made of metal, because metals exhibit excellent thermal conductivity and are thermally and mechanically very stable. There are, however, a wide range of applications for which metal equipment is not permissible for a number of reasons. This can be the case, for example, if the fluids used in the heat exchanger are highly corrosive. Metals might also be problematic because of specific process requirements, such as products that must not be contaminated by even the smallest traces of a metallic material. In such cases, glass or one of a number of ceramics are typically used instead.

Up until now, heat exchangers made of plastic have tended to be niche products, but their area of use is expanding constantly. Plastics have very unfavourable thermal conductivity coefficients (with average values of around 0.25 W/(m·K)) that are well below those of metals (50–250 W/(m·K)). In addition, there are only a few plastics that are able to be used at temperatures above 60 °C. Nevertheless, the outstanding chemical resistance and competitive pricing of some of these materials makes them of potential interest. A range of studies and development projects have now been performed that confirm the performance capabilities of plastic heat exchangers. Most of the systems tested have been tube bundle heat exchangers made from polypropylene [1, 2, 3].

A novel concept for plastic heat exchangers was developed at the Department of Separation Science and Technology at Kaiserslautern University of Technology as part of project 240 ZN supported by the German Federation of Industrial Research Associations (AiF). The concept is based on the principle of a plate heat exchanger in which thin films of polymer (thickness: 25 µm) provide the heat transfer surfaces [4]. The system was designed for a desalination process, i.e. for use in a highly corrosive environment. Not only was it possible to achieve heat transfer coefficients comparable to those attainable with metal heat exchangers, but there was also significantly less propensity to fouling.

The experience gained in that project was used as the basis for expanding the concept to cover industrial processes involving chemical reactions and thus open up new areas in which this novel type of heat exchanger might be applied. The objective was not just to achieve efficiency gains by improving heat transfer, particularly in light of the lower tendency for system contamination, but also to reduce CO<sub>2</sub> emissions associated with the equipment manufacturing process. This is another benefit of using polymeric materials, as they can be processed using far less energy (thermal or electrical) than is required when processing metals, glass or ceramics.

### 3.6.2 Project description

The primary goal of the project was to develop a novel heat exchanger for chemical processes. The underlying design concept was derived from AiF project 240 ZN conducted at the Department of Separation Science and Technology at Kaiserslautern University of Technology in which a polymer film heat exchanger for marine desalination was developed and successfully tested.

The structure of the heat exchanger is shown in Figure 94.

The heat exchanger is modular in structure, with gaskets, polymer films and the intermediate plate sandwiched between the solid end and connecting plates. The intermediate plates have a studded surface that helps to guide the flow of fluid and supports the polymer films. The purpose of the film is to separate the two fluids and to act as a heat transfer surface. To compensate

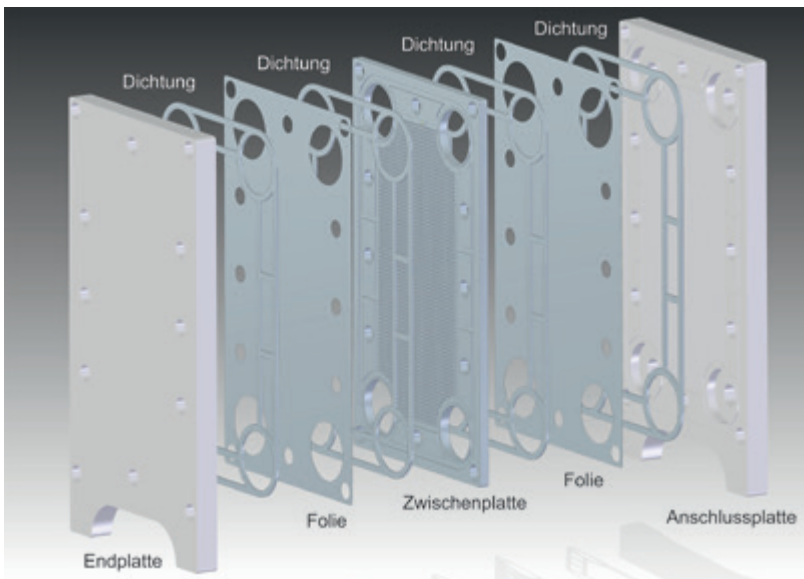

Fig. 94:  
CAD drawing of the final  
version of the demonstrator

for the poor thermal conductivity of the polymers (approx.  $0.25 \text{ W/m}^2$ ), the heat transfer wall is configured as a thin polymer film with a thickness between  $75 \text{ }\mu\text{m}$  and  $150 \text{ }\mu\text{m}$ . The total heat transfer surface area in the unit can be enlarged if required. The plates have the dimensions  $500 \text{ mm} \times 300 \text{ mm}$ .

A practically relevant application for the test system was defined by the project partner Merck KGaA. The main area of application proposed was the condensation of organic solvents, such as hexane, heptane, toluene or tetrahydrofuran, which are common solvents used in industrial technical centres. Additional operating parameters, such as mass flows and maximum temperatures were also specified and are shown in Table 5.

Table 5: The operating conditions defined for the project

Product volume flow rates	20 – 100 l/h
Cooling water volume flow rates	$0.5 - 2 \text{ m}^3/\text{h}$
Product temperatures	$\sim 100^\circ\text{C}$
Cooling water temperature range	$\sim 100^\circ\text{C}$
Additional requirements	Positive pressure on cooling water side: approx. 4 bar

Calorplast GmbH joined the project as a partner organisation with responsibility for designing and manufacturing the heat exchanger. With extensive experience in the construction of heat exchangers from polymeric materials, Calorplast GmbH was able to contribute a high level of expertise to the project. The participation of Calorplast ensured that the results from the basic research work conducted at Kaiserslautern University of Technology could flow directly into the prototype development phase.

The final demonstrator is shown in Figure 95. Pictured on the left is a heat exchanger with five intermediate plates, i.e. with a total of six chambers per fluid. The heat exchanger was always operated in cross-flow mode. The right hand panel in Figure 95 shows a close-up of the slots for the gaskets and also shows the studded structure that is used to hold the film in place. The fluid enters the exchanger via an arc-shaped fluid distributor and a curved channel. The fluid then enters the milled flow ducts between the polymer film and the base or intermediate plates.

The following work packages were carried out during the project:

1. Fundamental examination of the chemical resistance of the polymer film material under mechanical and thermal loading
2. Experimental determination of the optimum structure of the studded surface that holds the film in place
3. Design and fabrication of the lab-scale and pilot-scale demonstrators
4. Development of numerical models to calculate heat transfer characteristics.

To carry out the tests of mechanical strength and chemical resistance, a pressurised test vessel was developed that enabled long-term stress tests to be performed in which the films were in continuous contact with the relevant organic solvents and at a constant temperature of up to 90 °C. The tests were conducted under conditions of constant mechanical loading (pressures of up to 6 bar, applied perpendicularly to the film) and under pulsed loading (between 45 and 550 load cycles per hour for up to 1200 hours).

To study the heat transfer characteristics, a new test rig was developed that enabled both liquid-liquid and condensation experiments to be performed. The liquid-liquid tests were carried out with water (as this simplified the validation of the numerical models), while the condensation experiments were carried out using hexane.

### 3.6.3 Results

The project results can be split into three groups: the results from the basic testing of the material properties of the polymer films, the results of the experimental studies of heat transfer using the demonstrators, and the results of the numerical modelling work.



Abb. 95:  
Left: Demonstrator in operation;  
Right: Base plate showing the  
gasket and the studded surface  
that supports the film

It could be shown that the behaviour of the polymer films at high temperatures was completely different to the behaviour observed at, for example, room temperature. This is particularly true of the observed chemical resistance of the films. An extensive search of the available literature resulted in the selection of two types of film based on their chemical resistance: a polyimide film (thickness: 75  $\mu\text{m}$ ) and a PTFE-glass fibre composite (thickness: 150  $\mu\text{m}$ ). Both films showed significant weakening, particularly when they were in prolonged contact with toluene and tetrahydrofuran. The deformation of the films observed after two months of exposure to toluene was about twice that observed in the tests carried out with water. It was also found that the polyimide film caused discolouration of the tetrahydrofuran and that it failed before the planned end of the experiment. The best behaviour under constant load conditions was exhibited by the PTFE-glass fibre composite. The polyimide film performed significantly better in the alternating load tests and was able to withstand 100,000 load cycles without problems, while the PTFE-glass fibre composite failed after only 10,000 to 20,000 load cycles [5, 6, 7].

The heat transfer measurements were carried out using a smaller lab-scale heat exchanger (180 x 180 mm) and using the demonstrator described above (see Figure 2). When running in liquid-liquid mode (water-water, water-hexane) both devices produced total thermal transmittance values in the range of 300–400  $\text{W}/(\text{m}^2\cdot\text{K})$ . At smaller volume flow rates, the polyimide film showed a slightly larger heat transfer coefficient (approx. 10%) than the PTFE-glass fibre composite film. This can be explained by the surface structure of the PTFE, whose low surface energy favours the formation of rivulets thereby reducing the size of the surface involved in the transfer of heat energy. When running in condensation mode, much higher heat transfer coefficients of up to 1000  $\text{W}/(\text{m}^2\cdot\text{K})$  were measured [8, 9].

Ultimately, it was only possible to operate the demonstrator with a PET film. This was due to durability problems with the gasket materials. Although the PTFE-glass fibre composite was the only material able to fulfil the criteria regarding chemical resistance (particularly chemical resistance to organic solvents), it was not possible to produce an adequate seal with commercially available materials that were sufficiently chemically resistant. In order to demonstrate the basic functionality of the demonstrator, testing was carried out using a PET film (thickness: 100  $\mu\text{m}$ ) and a soft fluoroelastomer seal, which was resistant to alkanes but had to be replaced after about 100 hours of operation.

The numerical studies covered simple models with rigid geometries and pure CFD analyses as well as coupled models aimed at simulating the films that deformed under pressure (flexible boundary conditions). The latter ap-



proach was necessary in order to be able to model the effect of changing film geometry on fluid flow. For single-phase heat transfer, the model produced results of very good accuracy (5–10%). However, the modelling of heat transfer when a phase-transition was also involved (condensation mode) proved significantly more challenging. While it was possible to simulate the physical process of phase change, the energy balance analysis was too inexact for technical application (errors of up to a factor of 10). The coupled modelling was based on the principles of fluid-structure interaction (FSI) and small-scale implementation was possible if simplifications were introduced. It was not possible to perform simulations of the entire geometry of the structure due to the enormous computational resources required by the commercial software package used (>120 GB RAM). The software package consisted of modules for flow, heat and mechanical strength simulations. Work is currently underway to optimise networking between these modules.

### 3.6.4 Exploitation, commercialisation and dissemination of results

The EP-Wüt project demonstrated that polymer films are fundamentally suitable for use in heat exchangers in chemical processes and this important finding provides the basis for further development projects. There are however a number of issues that need to be resolved, particularly regarding integrity against leaks. The fact that the heat transfer coefficients achievable with polymer film systems were comparable to those attainable in conventional heat exchangers showed that there is real potential for developing polymer film heat exchangers as a marketable technology.

The fundamental studies of material properties yielded important insights into material behaviour under combined chemical, thermal and mechanical loading – an area that had not been examined previously and for which there were no comprehensive datasets available in the literature. These results have opened up a number of other potential areas of application of these high-performance polymers beyond their use in heat exchangers. They appear particularly attractive for applications involving corrosive media and can replace high-alloy metals or ceramics at temperatures of up to 200 °C. They may also find use as electrical insulators at moderate temperatures. The project also yielded important findings concerning the gasket material (PTFE foams, fluoroelastomers). The results demonstrated the need for further basic research in this area, which in turn can be used to encourage future technical development.

For the project partner Calorplast GmbH – a company specialised in the development and manufacture of heat exchangers from polymeric materials

– the results from the EP-Wüt project expanded its technical expertise and substantially improved its position in the industrial sector. For technology users, such as Merck, technical publications and presentations are helping to disseminate knowledge about the potential uses and constraints of this technology.

The numerical models developed to determine the heat transfer characteristics in systems with complex geometries and variable boundary conditions can also be used as the basis for future development work. The coupled FSI models in particular are of considerable interest to those working in other fields, such as engineers carrying out aerofoil and wing simulations in the aerospace industry. Future developments in these areas will, however, depend on improvements to the code by the software companies involved.

## References:

1. L. Zaheed, R.J.J. Jachuck, Review of polymer compact heat exchangers, with special emphasis on a polymer film unit. *Applied Thermal Engineering*. 2004, 24, 2323.
2. L. Chen, Z. Li, Z.-Y. Guo, Experimental investigation of plastic finned-tube heat exchangers, with emphasis on material thermal conductivity. *Experimental Thermal and Fluid Science*. 2009, 33, 922.
3. J. R. Burns, R.J.J. Jachuck, Condensation studies using cross-corrugated polymer film compact heat exchanger. *Applied Thermal Engineering*. 2001, 21, 495.
4. J.B.P. Christmann, L.J. Krätz, H.-J. Bart, Falling film evaporation with polymeric heat transfer surfaces. *Desalination*. 2011, 308.
5. D. Laaber, H.-J. Bart, Chemical and pressure stress resistance of polymer films, *Polymer Testing*, 40 2014, 280.
6. D. Laaber, H.-J. Bart, Chemical Resistance and Mechanical Stability of Polymer Film Heat Exchangers, *Chemie Ingenieur Technik*, 2015, 87, 1.
7. D. Laaber, H.-J. Bart, Untersuchung des Langzeitverhaltens von Kunststofffolien für den Einsatz in Wärmeübertragern, *Chemie Ingenieur Technik*, 2013, 85, 9, 1467
8. D. Laaber, H.-J. Bart, Polymerfilm-Wärmeübertrager für chemische Prozesse“, Begleitheft zur ProcessNET 2014, Aachen
9. D. Laaber, H.-J. Bart, Hochflexibel Wärme übertragen, *Chemie Ingenieur Technik Plus*, 03/2014, 28

## 3.7 OPHINA – Organic solvent nanofiltration for energy-efficient processes

BMBF Project FKZ 033RC1001

Project Coordinator: Dr. Daniela Kruse, Evonik Industries AG

Project Partner: Bayer Technology Services GmbH, BASF Personal Care and Nutrition GmbH, RWTH Aachen

### 3.7.1 Introduction

Avoiding CO<sub>2</sub> emissions is an important element in the strategy to reduce levels of climatically relevant gases. In addition to mitigating CO<sub>2</sub> emissions by finding substitutes for fossil fuels, a key role is also played by measures designed to lower consumption of typically fossil-based energy resources. Optimising the energy efficiency of processes can make an important contribution to CO<sub>2</sub> abatement.

Many processes in the chemical industry use solvents and these have to be recovered later on in procedures that consume a lot of energy. By using energy-efficient separation methods, the energy consumed by a process and therefore the CO<sub>2</sub> emissions associated with it can be reduced significantly. One such energy-efficient separation technology is organic solvent nanofiltration (OSN), which, in contrast to conventional thermal separation techniques, does not require the input of heat. The goal of the collaborative research project 'Ophina' was to develop technology that would reproducibly produce OSN membrane modules at consistently high quality for use in industrial-scale separation processes. The work focused, in particular, on key module parameters such as solvent resistance, permeate flux, retention (selectivity) and long-term mechanical stability.

### 3.7.2 Project description

The objective of the Ophina project was to develop a new generation of membrane modules based on composite membranes. Composite membranes were chosen as they showed improved mechanical stability, solvent resistance, selectivity and permeability in OSN applications. The aim was to manufacture a variety of membrane modules and then subject them to user testing. The tests in a wide range of applications were designed to determine precisely how organic solvent nanofiltration saves energy and resources. Other questions of interest included the potential of OSN to replace or com-

plement distillation, the use of OSN for the separation of homogeneous catalysts and for product purification, and studies of possible hybrid processes.

### 3.7.3 Results

The focus of the research project was initially on the membrane materials. The performance of a number of different membrane materials was studied and the results compiled in a property matrix that enabled the requirements of specific separation processes to be individually addressed without the need to invest in major development work. Any gaps in the property matrix were closed by developing and synthesising new membrane materials. Using this approach, three different substructures of highly selective membranes with a molecular weight cut-off between 250 g/mol and 800 g/mol were developed that have the potential to be used in a large number of OSN applications. Two generations of flat-sheet silicone composite membranes were also developed in response to the requirements of industrial users for membrane filtration operations. The flat-sheet materials were used to fabricate small-scale membrane modules for testing purposes. The performance of the membrane was not impaired by incorporation into the module. The materials used in the construction of the modules were selected to meet the requirements of most industrial processes. The larger modules with dimensions of 8" x 40" were developed in collaboration with the project partners Evonik MET and CUT.

The sheet material and the modules were tested in a variety of processes. Of the 21 processes identified, 19 were subjected to detailed evaluation and the suitability of the membranes for use with each process was determined. In addition to examining the options for incorporating pure OSN equipment, project members also addressed the question of using membrane-based filtration to replace thermal separation techniques and analysed the possibility of combining OSN technology with other separation methods in novel hybrid processes. The economic feasibility of the various technological solutions was based on estimates of membrane filtration performance and length of service life. A four-week test under realistic operating conditions showed that the membrane module exhibited both long-term performance stability and solvent resistance.

Modelling based on the measurement data collected was used to assess cost effectiveness and to identify the optimum process parameters. Of the 19 OSN applications examined in the Ophina project, commercial feasibility could be demonstrated for a total of eight processes. The membranes and membrane modules tested showed good separation performance, high stability with respect to a range of different solvents and the potential to

significantly reduce energy consumption. A full life cycle assessment of the membrane modules was also performed. The results of the membrane LCA can then be used to carry out a complete LCA for those products for which OSN is used in the production process and the remainder of the production process is well defined.

### 3.7.4 Exploitation, commercialisation and dissemination of results

The Ophina project has made a significant contribution to making organophilic nanofiltration known within the Evonik Group as an energy- and resource-saving process. A technology platform researched as part of the project was then further developed by Evonik and brought to product maturity. Evonik invested in manufacturing technologies for the production of composite membranes and successfully introduced the resulting products, for which research in the project was the cornerstone, to the market for special membranes for organophilic nanofiltration. In internal applications, Evonik has successfully equipped two new processes with membrane systems for organophilic nanofiltration. One of these processes is on a production scale, another will be transferred to production next year.

## 3.8 LICIL – Methods for Extracting Lignin, Cellulose and Hemicellulose with the Aid of Novel Ionic Liquids

BMBF Project FKZ 033RC1112

Project Coordinator: Prof. Dr. Willi Kantlehner, Hochschule Aalen

Project Partner: Hochschule Aalen, Universität Hamburg, Bayer Technology Services GmbH, J. Rettenmeier & Söhne GmbH + Co KG, Rampf Eco Solutions GmbH & Co KG, Fa. Jelu (assoziierter Partner ohne BMBF Zuwendung), Universität Stuttgart, Institut für Technische Chemie (assoziierter Partner ohne BMBF Zuwendung)

### 3.8.1 Introduction

Cellulose was already being manufactured from wood in the 19th century. In the sulfite process, which was developed by Tilghman in the USA and by A. Mitscherlich in Germany, debarked wood is pulped by cooking it in a calcium sulfite solution that contains excess sulfur dioxide for a period of 7–25 hours at a temperature in the range 115–150 °C and at a pressure of between 3 bar and 7 bar. The hemicellulose and the lignin are dissolved as lignin sulfonates. In the sulfate process (also known as the kraft process), which was invented by the chemist Carl Dahl, pulping is carried out by cooking the wood chips in solutions of sodium hydroxide and sodium sulfide at 150–180 °C and 7–10 bar for a period of three to six hours. In both processes, the resulting wood pulp contains the undissolved cellulose. At the end of the process, the cooking liquors can be processed to recover lignin derivatives, which despite being frequently referred to as ‘lignin’ are in fact degraded lignins [e.g. lignin sulfonic acids (in the sulfite process) or lignin sulfides and hydrogen sulfides (in the kraft process)]. But only a small fraction of the pulping liquors are processed to recover ‘lignin’ for recycling. Most of the pulping liquor is evaporated to dryness and combusted for energy recovery.

An observation originally made a long time ago and clearly overlooked was that cellulose dissolves in low-melting ammonium salts [1] and it was this finding that provided the impetus to examine the solubility of cellulose in ionic liquids [2]. In related work, studies were also conducted to investigate the extent to which lignocelluloses [3, 9] and lignin [3, 7, 9] dissolve in ionic liquids (ILs). Summaries of studies of this type have been published [3–11]. The acidic IL [C<sub>4</sub>C<sub>1</sub> im] H<sub>2</sub>SO<sub>4</sub> almost completely dissolves the hemicellulose (approx. 24%) and lignin (approx. 28%) from *Miscanthus* within 22 hours at 120 °C [3]. It was also possible to extract lignin and hemicellulose almost completely from willow and pine wood [3]. A pilot project was initiated in

which pulping was carried out using ILs with different anions under a variety of pulping conditions. Evaluation of the tests performed showed that the costs of these processes are too high [12].

In two consecutive collaborative projects funded by the German Ministry of Agriculture [12, 13], wood chips from beech and poplar trees were pulped by immersion in a mixture of water and ethanol in the presence of approx. 0.5% sulfuric acid at 150–200 °C and 5–20 bar. The pulping concept was based on preliminary work performed by Lenzing AG [14]. Under optimised conditions, large-scale production of fibre fractions comprising about 65% cellulose, approximately 15% lignin, 15% xylan and 4% acetic acid was achieved. The lignin fractions exhibited a carbohydrate content of approx. 2% and a lignin content of 90% [13].

In a recently published pulping procedure, alkaline glycerol was used to dissolve and extract the lignin and hemicellulose from wood to leave the cellulose [15]. This process, which is referred to as the 'Alka Pol P' process, can be considered to be a variant of the alkaline pulping (or 'soda pulping') process that is already used commercially.

The principles underlying catalytic pulping of plant biomass were described in a recent review article [16]. One innovative approach is that of the 1-Step OrganoCat Process in which biomass is fractionated in a single stage by pulping in a two-phase water/2-methyl tetrahydrofuran system at 80–190 °C in the presence of acid (oxalic acid, formic acid). The hemicellulose sugars dissolve in the water, the lignin dissolves in the 2-methyltetrahydrofuran and the cellulose, which remains undissolved, can then be removed [17].

### 3.8.2 Project description

The objective of the project was to develop an economically viable, unpressurised pulping process for extracting sulfur-free lignin, cellulose, hemicellulose and resins from biogenic material that could be operated at a temperature of around 80 °C and would require only a few hours to complete. The process would produce non-degraded wood components thus enabling cost-effective recycling of all components. Cellulose is used, for example, in the pulp and paper industry, as an additive in building and construction materials, such as rendering, as an auxiliary filter material and as a filler in the production of thermosetting polymer materials.

Sulfur-free lignin can be used as feedstock for the production of petrochemical building blocks and fuels and in the manufacture of industrial pellet products and road building products (as a bitumen substitute). A particular-



ly valuable commercial use of lignin would become possible if it could be transformed into carbon fibres for use in lightweight engineering construction (airplane parts, wind turbine rotor blades) or as corrosion-free substitute for steel in reinforced concrete parts. Lignin can also function as the polyol component in the manufacture of polyurethane foams. It is also conceivable that lignin could be used as an energy storage medium.

Novel ionic liquids known as RIBILs (Reactive Iminium-Salt-Based Ionic Liquids) – alkoxymethyleniminium salts **1** – were selected as the pulping medium as they dissolve lignin and hemicellulose but not cellulose [18] and were therefore suitable for the following pulping concept. The wood chips or wood flour are heated in an ionic liquid (e.g. **2–6**) to a temperature of about 80 °C and the suspension stirred. The undissolved cellulose is separated. A suitable solvent is then added to the ionic liquid, which contains the dissolved lignin and hemicellulose, to precipitate the lignin and then extract it by filtration. The hemicellulose is then recovered from the filtrate.

The ionic liquids should be capable of being reused multiple times and should be recyclable.

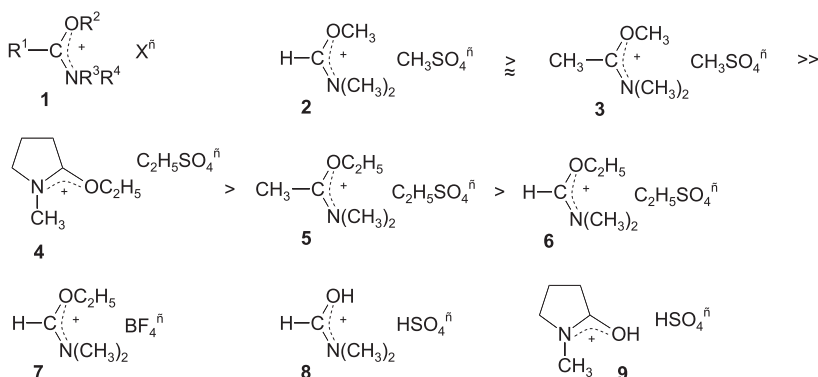

As the iminium salt solutions containing the lignin and hemicellulose are very viscous, separating the cellulose from the solution by filtration proved very tedious. If IL compounds of type **1** are used for pulping, addition of a co-solvent such as ethylene glycol, methyl glycol or tetrahydrofurfuryl alcohol enables filtration to be carried out without difficulty, though the degree of delignification is reduced. The delignification capacity of pulping systems using an ionic liquid of type **1** and an organic co-solvent increases with rising temperature (>80 °C), as was demonstrated using a pulping system comprising the IL **7** and methyl glycol (x = 2 : 108).

For toxicological reasons, the pulping capacity of hydroxymethyleniminium salts such as **8** and **9** was examined, because at temperatures above 100 °C,

adducts like 2 dissociate to form N,N-dimethylformamide and dimethyl sulfate). The pulping efficiency of the salts 8 and 9 is comparable to that of the ILs 2 and 4.

Using the hydroxymethyleniminium salts 8 or 9 at a raised temperature (>100 °C) in combination with organic solvents like ethylene glycol, glycerol, 1,3-propanediol, methyl glycol or tetrahydrofurfuryl alcohol, enabled catalytic pulping of spruce wood within 2 hours for a mass ratio  $x$  ( $m_{\text{wood}} : m_{\text{IL}} : m_{\text{co-solvent}}$ ) = 15 : 2 : 108. High degrees of delignification were achieved using the co-solvents methyl glycol or tetrahydrofurfuryl alcohol. The fibre yields were between 45% and 54%; the lignin yields ranged from 21% to 25%. The cellulose content of the fibre fraction was about 82%; the lignin fraction contained approximately 84% lignin. The molar masses of the lignins were around 8500 D. Longer reaction times (8 h) change neither the yield nor the quality of the fibre or lignin fraction, though the molar masses of the lignins increases by about 10%.

If instead of using the pulping systems involving 8 and methyl glycol or tetrahydrofurfuryl alcohol, pulping is carried out with mixtures of sulfuric acid and one of the co-solvents, both the fibre and lignin yields are reduced and the products have a strong yellow to brown discoloration. The cellulose fibres are also shorter and exhibit a very non-uniform fibre length distribution.

The pulping systems involving the hydroxymethyleniminium salts and co-solvents could be used at least three times, as was demonstrated by a mixture of 8 (DMF/H<sub>2</sub>SO<sub>4</sub>) and methyl glycol (the total yield of extracted lignin was 18%), the fibre yield by the third extraction rose to 74%, as its lignin content increased.

Initially, the pulping liquor was filtered or centrifuged to remove the cellulose. The lignin was then precipitated out of the filtrate by adding water and collected by filtration. The residual filtrate was then evaporated to dryness to recover the hemicellulose. Modifying the post-pulping workup procedure saved energy and made material recycling more effective. The new workup procedure involved neutralising the acidic filtrate once the cellulose had been removed and then distilling off the co-solvent. Addition of water to the residual solution caused precipitation of the lignin, which was then separated by filtration. Subsequent evaporation to dryness yielded the hemicellulose. If the acid component was not neutralised, the molar mass of the lignin was twice as large (pulping with 2 in methyl glycol).

This pulping method was also successful with spruce chippings. The efficiency of the pulping process is reflected in the fibre and lignin yields as well as in the shive fraction and is strongly dependent on the co-solvent used

(tetrahydrofurfuryl alcohol, for instance, is significantly better suited than methyl glycol).

Mixtures of the IL 2 and a large number of organic solvents were examined as wood pulping media. The following compounds have been shown to be well suited to use as a pulping co-solvent:

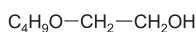
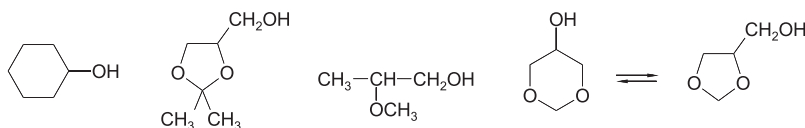

Equally suitable were the following aprotic solvents:

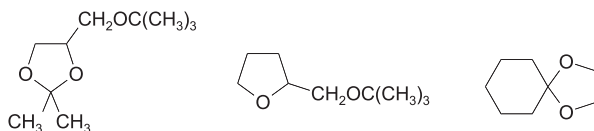

## 3.8.3 Results

### 3.8.3.1. A novel wood pulping process

A novel catalytic pulping process for spruce wood was developed in which mixtures of acidic iminium salts ('RIBILs') or ammonium salts and organic co-solvents are used as digestion media. The advantages of this new process are:

1. The new process can be operated cost effectively, as it requires significantly less energy than conventional processes. The process can be carried out at low liquor ratios, and the reaction time is short (approx. 2 h) at relatively low temperatures (about 120 °C) at standard pressure. The process can be implemented using established methods and existing plant equipment and can be adopted by companies already working in the sector, as only minimal conversion work or investment in new plant equipment is required.
2. There is only a minor loss of chemicals during the process and no noxious smelling substances are released. The chemicals used in the process are inexpensive, simple to recycle and of low corrosivity.

3. The materials recovered in the pulping process – cellulose, lignin, hemicellulose and resins – are practically chemically unchanged and are produced with high yield and in high purity, which means that they can all be recycled. The structure of the cellulose fibres and the molar mass of the lignin are controlled by the choice of chemical compounds that make up the pulping system.
4. A series of reactive iminium-salt-based ionic liquids (RIBILs) and a number of organic solvents were identified that when mixed constitute a suitable wood pulping medium.
5. The process was successfully scaled up from 100 millilitres to 1000 litres.

### 3.8.4 Exploitation, commercialisation and dissemination of results

#### 3.8.4.1 Scaling up the wood pulping process for industrial-scale operation

The intended sequential scale-up of the process to an industrial-scale operation will only succeed if the initial stages of the transition are facilitated by funding from central government (e.g. through the funding programme for innovative technologies designed to improve resource efficiency). If it proves possible to scale the process up to industrial levels, significantly lower amounts of primary energy will be needed for wood pulping and all of the wood feedstock will be recycled.

#### 3.8.4.2 Scientific publications and patentable results

The crystal structures of *N,N*-dimethylalkoxyalkylideneiminium salts [19–21] and carbohydrate derivatives [22,23] have been published. A patent application for the wood pulping process was filed in 2015.

#### 3.8.4.3 Recycling of the products extracted in the pulping process

##### Cellulose

In terms of output quantities, cellulose is the main product of the wood pulping process. Cellulose is used in key industrial sectors (e.g. plastics, paper, textiles, food and pharmaceuticals). New innovative technical applications, such as nanocellulose, are currently under development.

**Lignin**

Lignin is finding increasing use in the field of polymer chemistry (e.g. polyurethanes, polyesters, carbon fibres), as well as in the manufacture of flame retardants, fuels and energy storage media. The manufacture of surfactants from lignin also appears possible. A number of research projects are currently examining the feasibility of synthesising aromatic compounds from lignin.

**Hemicellulose**

Initial studies seem to indicate that hemicellulose can be used in the areas of biotechnology, polymer chemistry and fuel chemistry.

## References:

- [1] C. Craenacher, U.S. 1.924.238 (29.3.1933) *Chem. Abstr.* **1933**, 27, 5535; C. Craenacher, U.S. 1.943.176 (9.1.1934), *Chem. Abstr.* **1934**, 28, 1860]
- [2] A. Pinkert, K. N. Marsh, S. Pang, M.- P. Staiger, *Chem. Rev.* **2009**, 109, 6712-6728; A. Pinkert, K. N. Marsh, S. Pang, *Ind. Eng. Chem. Res.* **2010**, 49, 11809-11813; M. Mazzan, D. A. Catana, C. Vaca-Garcia, C. Cecutti, *Cellulose*, **2009**, 16, 207-215; A. R. Lin, J. J. Wang, H. Y. Wang, *Green Chem.* **2010**, 12, 268-275; T. Liebert, T. Heinze, *BioResources* **2008**, 3, 576-601)
- [3] A. Brandt, M. J. Ray, T. Q. To, D. J. Leak, R. J. Murphy, T. Welton, *Green Chem.* **2011**, 13, 2489-2499.
- [4] G. Laus, G. Bentivoglio, H. Schottenberger, V. Kahlenberg, H. Kopacka, T. Röder, H. Sixta, *Lenzinger Berichte* **2005**, 84, 71-85.
- [5] P. Domínguez de Maria, *J. Chem. Technol. Biotechnol.* **2014**, 89, 11-18.
- [6] A. W. T. King, J. Asikkala, I. Mutikainen, P. Järvi, I. Kilpeläinen, *Angew. Chem.* **2011**, 123, 6425-6429.
- [7] Md. M. Hossain, L. Aldous, *Austr. J. Chem.* **2012**, 65, 1465-1477.
- [8] M. Gericke, T. Liebert, T. Heinze, *Nachrichten Chemie* **2011**, 59, 405-409.
- [9] N. Sun, H. Rodríguez, M. Rahman, R. D. Rogers, *Chem. Commun.* **2011**, 47, 1405-1421.
- [10] H. Ohno, Y. Fukaya, *Chemistry Lett.* **2009**, 38, 2-7.
- [11] Z. Papanyan, C. Roth, D. Paschek, R. Ludwig, *ChemPhysChem* **2011**, 12, 2400-2404.
- [12] Pilotprojekt "Lignocellulose-Bioraffinerie", Gemeinsamer Schlussbericht zu den wissenschaftlichen-technischen Ergebnissen aller Teilvorhaben (FKZ: 22027405, 22014106, 22014206, 22014306, 22014406, 22001307), Hrsg. J. Michels **2009**.
- [13] Pilotprojekt "Lignocellulose-Bioraffinerie", Aufschluss lignocellulosehaltiger Rohstoffe und vollständige stoffliche Nutzung der Komponenten (Phase 2), Gemeinsamer Abschlussbericht zu den wissenschaftlich-technischen Ergebnissen aller Teilvorhaben (FKZ: 22029508, 22019009, 22019109, 22019209, 22019309, 22019409, 22019509, 22019609, 22019709, 22019809, 22019909, 22020009, 22020109, 22020209, 22022109), Hrsg. J. Michels **2014**.
- [14] W. Peter, D. Höglinger, *Lenzinger Berichte* **1986**, 61, 12-16.
- [15] N. Engel, M. Hundt, K. Schnitzlein, H. G. Schnitzlein, *GIT Laborfachzeitschrift* **2013**, 57, 243-245.
- [16] R. Rindaldi, *Angew. Chem.* **2014**, 106, 8699-8701.
- [17] T. vom Stein, P. M. Grande, H. Kayser, F. Sibilla, W. Leitner, P. Domínguez de Maria, *Green Chem.* **2011**, 13, 1772-1777.
- [18] ICFS GmbH (W. Kantlehner, S. Saur) D.O.S. 102010048614 A1, DE 102010048614, **2012**, *Chem. Abstr.* **2012**, 154, 508047.
- [19] I. Tiritiris, S. Saur, W. Kantlehner, *Acta Cryst.* **2014**, E70, 333.
- [20] I. Tiritiris, S. Saur, W. Kantlehner, *Acta Cryst.* **2015**, E71, 916.
- [21] I. Tiritiris, S. Saur, W. Kantlehner, *Acta Cryst.* **2015**, E71, 984-985.
- [22] I. Tiritiris, S. Tussetschläger, W. Kantlehner, *Acta Cryst.* **2015**, E71, 889.
- [23] I. Tiritiris, S. Tussetschläger, W. Kantlehner, *Acta Cryst.* **2015**, E71, 961-962.

## 3.9 Mixed-Matrix membranes for gas separation

BMBF Project FKZ 033RC1018

Project Coordination: Torsten Brinkmann, Helmholtz-Zentrum Geesthacht, Institut für Polymerforschung

Project Partner: Technische Universität Berlin, Sterling Fluid Systems Holding GmbH, Blücher GmbH

### 3.9.1 Introduction

Membrane technology is now an accepted industrial unit operation for the effective separation of gas mixtures. Membrane technology is used in the chemical and petrochemical industries to separate hydrogen, oxygen and carbon dioxide as well as to separate higher hydrocarbons from the 'permanent' gases. Examples of the latter include the separation of organic vapours from exhaust air streams, the recovery of monomers during the manufacture of polymers and adjusting the hydrocarbon dew point of natural gas or associated petroleum gas. When used in such applications, membrane separation is often superior to competing processes such as absorption, adsorption or cryogenic separation, or it can be combined with them to form beneficial hybrid processes [1].

At present, the membranes used for this type of separation operation are thin-film composite membranes with separation layers made from poly(dimethylsiloxane) (PDMS) or poly(octylmethylsiloxane) (POMS). One of the main disadvantages of these materials is that their selectivity towards higher hydrocarbons decreases with the increasing fugacity of these components in the feed gas stream. On the other hand, a major advantage of these materials is their high permeance, i.e. their selective permeability with respect to hydrocarbons, which enables the design and construction of competitively priced membrane systems [1] that are superior in performance to established conventional methods of separation.

To address the problem of decreasing selectivity, this project applied the mixed-matrix membrane (MMM) concept [2] and introduced high-performance adsorbents with a high affinity for heavy hydrocarbons into the polymer matrix. The goal was to develop highly selective mixed-matrix membranes and to use them to create a separation technology that is better at separating higher hydrocarbons from permanent gases than earlier membrane-based processes or other competing separation techniques.

### 3.9.2 Project description

To achieve the project's objective, a research consortium was established comprising the Department of Process Engineering at the Technical University of Berlin, the Helmholtz-Zentrum Geesthacht (HZG), Sterling Industry Consult GmbH/Flowserve SIHI Pumps and Blücher GmbH. The project work packages were: membrane development; materials characterisation; pilot-scale studies and module assembly, modelling and simulation studies; economic feasibility analyses and life cycle analysis.

The separation layer of the multilayer composite membranes was composed of PDMS and POMS as the polymer matrix materials and activated carbon as the dispersed inorganic filler. The polymers were dissolved in toluene or isooctane and mixed with a suitable cross-linker [3]. The activated carbon (AC) was supplied in spherical form by Blücher GmbH. It was based on a polymer material and exhibited a reproducible pore size distribution and porosity. The AC was ground in order to meet the requirements of the MMM production process. Both 1.5  $\mu\text{m}$  and 3.5  $\mu\text{m}$  mill fractions were used to fabricate the MMM. They were mixed with the polymer solutions and then uniformly dispersed by ultrasound irradiation so that no agglomerates formed. Another key feature of the manufacturing process was that the pore system of the AC was impregnated with a suitable solvent system prior to being mixed with the polymer solution in order to prevent pore blockage during membrane production. The coating solution was applied to a multilayer support structure comprising polyester fleece, asymmetric porous polyacrylonitrile membrane and a drainage layer made of PDMS. Once the MMM layer had been applied, the membrane was sealed with another layer of PDMS. Subsequent heat treatment was used to evaporate the solvent and facilitate polymer cross-linking. Figure 96 shows the manufacture of a

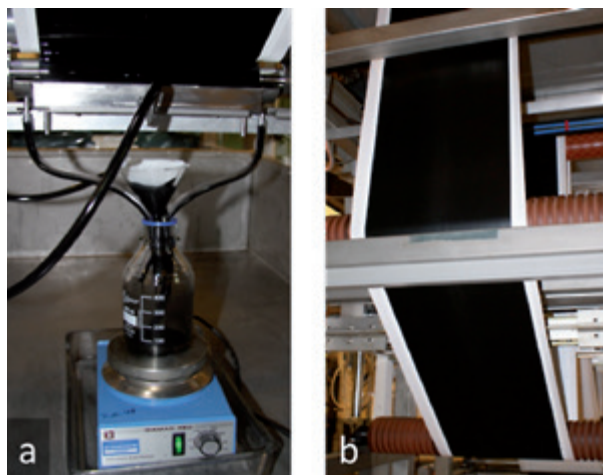

Fig. 96:  
Applying the AC/POMS  
coating solution to the  
support structure; (b) the  
MMM after cross-linking



30-cm-wide membrane sheet with lengths of up to 250 m. The membranes could be manufactured reproducibly with uniform quality.

The membranes were characterised by determining the permeation behaviour of individual gases and gas mixtures at different pressures, temperatures and compositions. The experiments were performed on MMMs and on pure polymer membranes for comparison purposes. The gas mixtures studied were methane/n-butane, nitrogen/n-pentane and a multicomponent mixture [3, 4]. The morphologies of the MMMs were determined using scanning electron microscopy and energy dispersive x-ray analysis. Tests were also carried out to measure the adsorption of methane and n-butane in the AC, in the two-phase mixed-matrix layers and in the pure polymer materials. Figure 97 shows the permeance values for n-butane and the n-butane/methane selectivity measured with a POMS/AC MMM and a pure POMS membrane. The greater selectivity of the MMM at higher pressures is readily apparent. However, the MMM was unable to achieve the permeance values obtained with a pure POMS membrane.

The modelling activity resulted in a mechanistic transport model for the MMM that provides a good simulation of the experimentally measured permeation behaviour [3].

An empirical model based on the experimental data was also developed for the purpose of process simulation. Figure 98 shows the results of one such simulation for the separation of n-butane from methane using either a POMS membrane or a mixed-matrix membrane. It shows that in a typical membrane separation set-up with partial recirculation of the permeate, the superior selectivity of the MMM can result in reduced energy consumption.

Fig. 97: Effect of feed pressure on a) the permeance of n-butane ( $n\text{-C}_4\text{H}_{10}$ ) and b) the n-butane/methane ( $n\text{-C}_4\text{H}_{10}/\text{CH}_4$ ) selectivity for a POMS/AC MMM and for a pure POMS membrane at 20 °C (binary mixture with a concentration of 5 mol-% n-butane in methane)

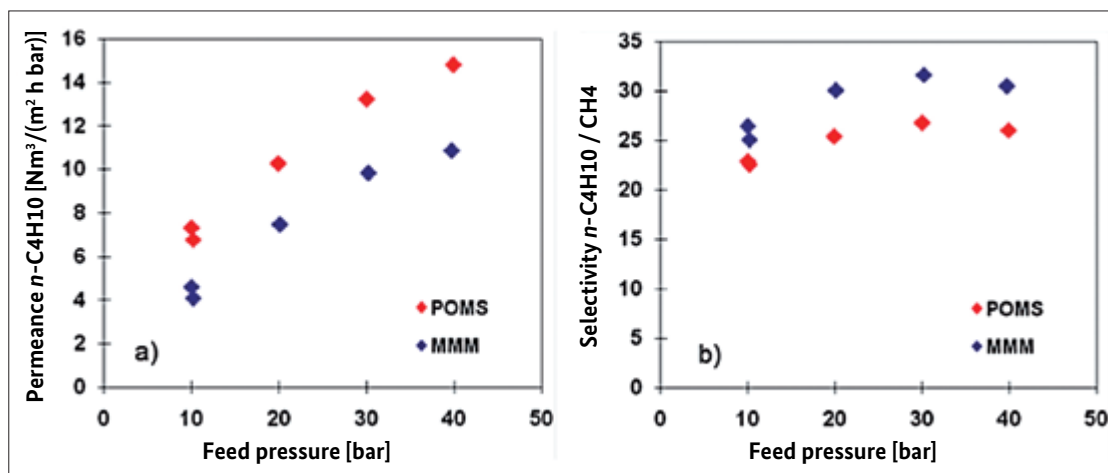
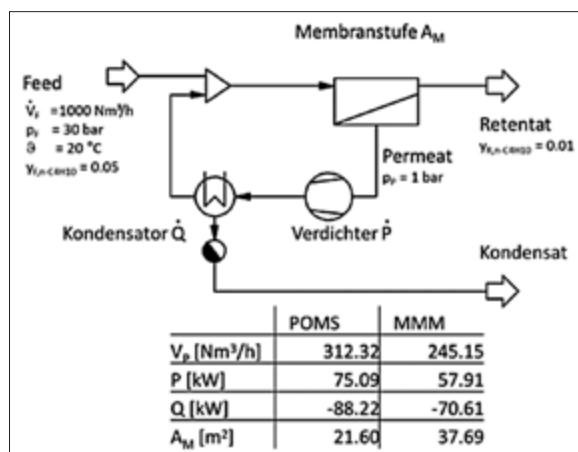

Fig. 98:  
Process simulation of the  
separation of *n*-butane from  
methane when using a pure  
POMS membrane and when  
using a mixed-matrix  
membrane



Life cycle assessments were also performed for a petrol vapour recovery unit equipped with a mixed-matrix membrane gas separation system. The LCA demonstrated that MMM technology produces environmental benefits when the electricity mix currently used in Germany is assumed.

The membrane material manufactured in the pilot-scale trials was incorporated into a membrane module with a membrane surface area of 8.6 m<sup>2</sup>. The module was then tested in a pilot plant at the HZG research centre. Slightly improved separation was observed, but the improvement was not as great as that measured earlier in the lab-scale tests.

### 3.9.3 Results

During this project, the fabrication of mixed-matrix membranes from rubbery polymers and activated carbon was successfully developed and then scaled-up for pilot-scale production. As far as we are aware, this is the first time that membranes of this type have been fabricated.

Studying the influence of the operating parameters on separation performance indicated that when compared with conventional POMS polymer membranes, mixed-matrix membranes perform best at high feed and permeate pressures, at low temperature and when the feed stream contains a large fraction of higher hydrocarbons, such as *n*-butane. These conditions result in a high mean fugacity of the higher hydrocarbons, which causes a strong rise in the permeance of the higher hydrocarbons. Compared with pure POMS membranes, the increase in the permeance of permanent gases such as methane is less pronounced, which leads to improved selectivity. Lab-scale studies also demonstrated the long-term stability of the MMMs developed in the project. While the initial pilot-scale tests confirmed the du-

rability of the mixed-matrix membranes, they were unable to replicate the separation behaviour measured in the laboratory, as it was not possible to reproduce the optimum operating conditions described above for the lab trials.

The mechanistic model developed in the project provided an ideal means with which to understand the coupled mass transport mechanisms, thus helping to develop and improve the MMMs.

The process simulations showed that the use of MMMs can result in substantial reductions in energy consumption, if the right operating conditions for their deployment can be arranged. The life cycle analyses performed also demonstrated the advantages that MMM technology could offer under the right operational conditions (e.g. the underlying electricity mix).

### 3.9.4 Exploitation, commercialisation and dissemination of results

The research and development work carried out in this project resulted in a technology package that forms the starting point for the applications-driven testing of mixed-matrix membranes described below.

A gas permeation pilot plant will be constructed at the HZG research centre with funding from the Helmholtz Association of German Research Centres. The proposed pilot plant will be designed for wound membrane pocket modules with a diameter of 100 mm and containing up to 1 m<sup>2</sup> of membrane area. The plant will be constructed for pressures of up to 60 bar and for a temperature range from -20 °C to 100 °C. The plant can therefore be operated within the range of operating points identified in the project as that for which the greatest increase in selectivity is observed. This will allow the potential of mixed-matrix membranes to be demonstrated at the pilot-plant scale – something that was not possible in the existing HZG pilot plant as it only allowed a restricted range of operating conditions to be accessed.

Originally, additional pilot-scale testing had been planned in which the MMM technology was to be incorporated in bypass mode in an industrial plant. This testing was not carried out during the project period but has since been completed at one of the customers of the project partner Sterling Industry Consult GmbH/Flowserve SIHI Pumps.

The mixed-matrix membrane concepts developed in the projects will be exploited in other research work on functional composites in which polymers are used as a matrix. As with the mixed-matrix membranes, the idea is to

combine the permeation properties of polymers with functional inorganic components. Examples include usage in membrane reactors and in fixed-site carrier membranes containing an inorganic carrier species.

Another important issue relevant to the future practical implementation of this technology is understanding the effect of secondary components on the separation performance of the mixed-matrix membranes. This sort of effect can be caused, for example, by water vapour that can become entrained in the feed gas if liquid ring pumps are used. As this type of pump is often used in the systems engineered by Sterling SIHI, it is important that this effect is studied as part of the proposed advanced pilot-scale trials.

The structure of the new mechanistic model is generally capable of describing mass transport processes across two-phase membranes and can therefore be used for systems other than that studied in this project. The model is therefore an improved and generally applicable methodological instrument for the theoretical description of membranes. The future implementation of the model within a process simulation tool is planned.

#### References:

- [1] K. Ohlrogge, J. Wind, T. Brinkmann, Membranes for Recovery of Volatile Organic Compounds. in *Comprehensive Membrane Science and Engineering*, Elsevier, 2010. doi:10.1016/B978-0-08-093250-7.00041-4.
- [2] S. Kulprathipanja, *Ann. N. Y. Acad. Sci.* 984 (2003) 361–369.
- [3] H. Mushardt, V. Kramer, D. Hülögü, T. Brinkmann, M. Kraume, *Chemie Ing. Tech.* 86 (2013) 83–91.
- [4] H. Mushardt, M. Müller, S. Shishatskiy, J. Wind, T. Brinkmann, *Membranes (Basel)*. 6 (2016) 16.

## 3.10 EEManagement – Energy efficiency management and benchmarking for the process industry

BMBF Project 033RC1008

Project Coordination: Dr. Christian Drumm, Covestro Deutschland AG

Project Partner: Bayer Technology Services GmbH, Bayer MaterialScience AG – Covestro AG (seit 01.09.2015), BASF Personal Care and Nutrition GmbH, bitop AG, Clariant Produkte Deutschland GmbH, instrAction GmbH, INOSIM Consulting GmbH, RWTH Aachen University Lehrstuhl für Prozesstechnik, Technische Universität Dortmund, Fakultät Bio- und Chemieingenieurwesen, Lehrstuhl für Anlagen- und Prozesstechnik, Lehrstuhl für Fluidverfahrenstechnik

### 3.10.1 Introduction

Energy efficiency is a key factor in determining success in the chemical industry, not just from an economic perspective, but also in social and political terms. As a result of increasing energy prices, energy costs now make up a very significant proportion of overall production costs. Furthermore, as a producer of greenhouse gases, the chemical industry has a duty to society to contribute significantly to achieving climate protection goals. At present, energy efficiency improvements represent the most effective and most economical lever with which to effect sustainable reductions in energy consumption. At the same time, legislative bodies are demanding ever greater improvements in energy efficiency, such as the revised exemption rules set out in the latest version of the German Renewable Energy Sources Act. The systems used to manage energy consumption are based on the requirements stipulated in the international standard ISO 50001. At present, energy efficiency management systems focus on identifying and quantifying (production-specific) energy consumers and on short-term initiatives aimed at identifying and implementing potential energy savings. Most of the effort is concentrated on large-scale continuous plants. Far less knowledge and experience has been acquired with respect to the significant energy saving potentials of life science processes. The sheer diversity of the industrial processes deployed, the use of different energy sources, the lack of appropriate benchmarks and the lack of an agreed definition and methods for measuring energy efficiency often represent serious obstacles that reduce the utility of these systems.

The foundation for this collaborative project was the energy management system STRUCTese® (Structured Efficiency System for Energy) that was de-

veloped by Bayer and is now being used by Covestro (previously Bayer MaterialScience) [1]. In many ways, the concept behind STRUCTese® goes beyond existing conventional approaches and beyond the requirements stipulated in the standards in that it attempts to make energy efficiency measurable and to separate the major factors affecting energy consumption in industrial plants and integrated production sites. This maximises transparency and enables ever more ambitious energy savings targets to be set based on quantified potentials (distance to the ideal energetically optimised process).

Objectively determining the minimum energy consumption targets and the associated process design needed to achieve them are therefore central elements of the STRUCTese® system. The lack of methodological tools available means that industry currently relies on empirical approaches that draw on expert knowledge and simulation studies. Academic research in the field has produced a number of innovative approaches for designing optimised processes, including heuristics, shortcut methods and rigorous optimisation.

A heuristics-based approach uses process knowledge and data from experience to distinguish between feasible and unfeasible process designs. This approach is particularly useful in restricting the theoretically infinite search space. Shortcut methods, in contrast, make use of simple process models to estimate the feasibility and minimum energy requirements of chemical processes without the need for detailed process specifications. Detailed rigorous models that simulate chemical and biotechnological processes take into account all of the transport effects occurring within the apparatus or plant equipment and can therefore be used to evaluate the accuracy of shortcut methods. The modelling of conventional thermal separation techniques such as rectification, absorption and extraction has already been extensively researched. In the case of membrane separation processes, whose low energy requirements make them promising candidates for achieving more energy-efficient processes, process modelling is still a challenge due to the complex interactions between the components and membrane materials.

### 3.10.2 Project description

The goal of this collaborative project was to develop a standardised energy efficiency management and benchmarking system that would be globally applicable, i.e. not restricted to specific companies, operations or processes, that would achieve a sustainable reduction in the energy requirements of process industries of more than 20% and that would reflect the most efficient technologies recognised by both the academic and industrial communities. Other key areas addressed in the project were the transfer of methods to life science processes and the development and improvement of the avail-

able tools to achieve the best possible synthesis of energy-efficient processes and plant equipment. In order to adequately test the methodology and regulatory framework, the proposed methodology was implemented and validated in five separate case studies.

Work on the project was therefore split into the following three large areas: the improvement, standardisation and dissemination of the STRUCTese® methodology (WP1); the development of tools to achieve the best possible synthesis of energy-efficient processes and plant equipment (WP2-4); and validation of case studies with an emphasis on life science processes (WP5).

The work on developing tools for achieving an optimal synthesis of energy efficiency and process equipment was split into three work packages: heuristics, short-cut methods, and process models and membrane processes.

The case-study validation work was carried out on production processes at BASF PCN, bitop, BMS, Clariant and instrAction. In these cases, the STRUCTese® methodology was implemented in the production processes and the experience gained was subsequently used to further improve the methodology.

### 3.10.3 Results

Developing the STRUCTese® methodology involved examining a number of different aspects, such as conversion to primary energy factors, the import and export of energy and mass flows, multiproduct plants and parallel production processes, and defining a clear set of rules on how these aspects should be described and how the resulting complexity can be mastered through application of the energy efficiency management system. Other methodological areas addressed included the adaptation of the system to batch and life science processes, for example by developing a modular approach that enables the methodology to be tailored to the requirements and needs of a specific plant or process.

The 'Heuristics' work package, which was part of the work aimed at identifying the best synthesis of energy-efficient processes, involved compiling rules for selecting energy-efficient unit operations and optimum operating conditions. Key areas studied were the energy-efficient operation of batch plants and of continuous plants operating with partial loads. The heuristic rules were published on an internet platform. In the field of shortcut methods, a number of powerful methods for extraction columns and adsorption columns were developed. The methods used to assess the energy requirements of separation processes were incorporated into a software module to facilitate their dissemination. Suitably rigorous process models were de-

veloped for organophilic membrane processes. The generic process models were also used as the basis for developing shortcut models.

The new methods were implemented within the STRUCTese® system to ensure that the energy optimum of a process is determined in a uniform and objective manner. The theoretical energy optimum plays a dominant role in the method used for defining process performance indicators and for benchmarking.

The case studies involved fully implementing the methodology in five production units operated by project partners with the aim of testing and completing the rules system developed during the project. The methodology implemented in the case studies also included the new methods developed by the project partners from academic institutions. In the case study that focused on applications in the life sciences, STRUCTese® was adapted appropriately to take account of the special aspects of this field, such as the smaller-scale production operations and the particular nature of the processes involved. Figure 1 shows an example of a STRUCTese® energy cascade generated for one of the case studies. The dark grey columns show the energy consumption levels (per kilogram of product) for a particular set of process conditions. The bar on the far right shows the energy consumption per kilogram of product that was actually measured, while the three grey bars to the left show the energy consumption levels of the process that are theoretically achievable after implementing specific improvement projects. The yellow bars represent energy efficiency losses, thus making it transparent to the user how the path to the theoretical optimum can be broken down.

For detailed project results, the reader is referred to the comprehensive final report on the project [2].

Fig. 99: STRUCTese® energy loss cascade for an example process

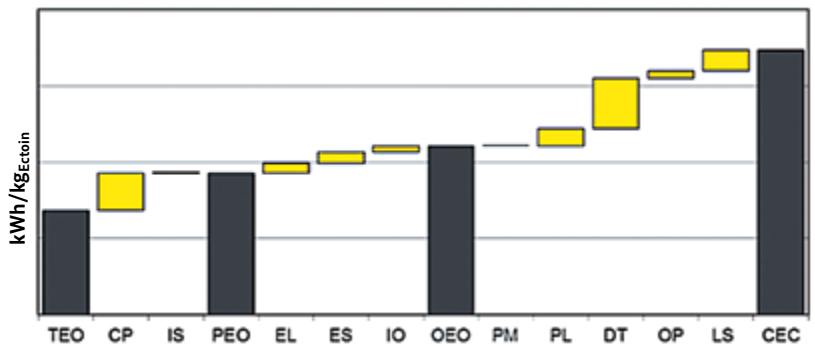



### 3.10.4 Exploitation, commercialisation and dissemination of results

With the help of the results achieved during the project, the STRUCTese® methods will be able to be applied globally in future, i.e. without being restricted to particular companies or processes.

The production processes at Covestro, BASF PCN, Clariant and bitop, where the STRUCTese® methodology was implemented for the purposes of project case studies, are already benefiting from reduced energy consumption levels and lower CO<sub>2</sub> emissions. At Covestro the STRUCTese® methodology has so far been introduced into 66 production units. In 2014, these production units saved a total of 1,500,000 MWh of primary energy. Based on the experience gained with the new energy-efficiency management system, Covestro has set itself the target of reducing the specific CO<sub>2</sub> emissions per metric ton of product by 40% over the period 2005 to 2020. Marketing and dissemination of the methodology is ongoing. In the life science field, the project partner INOSIM Consulting has been able to add STRUCTese® for Life Sciences to its existing project portfolio. The company bitop AG will be using the STRUCTese® concept in its product manufacturing processes, thus boosting their long-term sustainability. In contrast to bitop, the project partner instrAction does not operate its own production units. The core competence at instrAction is the development of innovative chromatographic materials that are sold worldwide. By using STRUCTese® Life Science, instrAction will be able to take into account the energy efficiency of those production processes in which its chromatographic materials will later be used during the material development stage. As a result, chromatographic materials from instrAction will enjoy a technological advantage over competitor products.

The next stage for the academic project partners will be to broaden the use of approximation methods and associated process design concepts in industrial practice. The results achieved during this project have already been integrated into teaching modules and are being used to heighten awareness among students for energy efficiency issues. The development of a generic process model for describing organophilic membranes now allows alternative energy-optimised processes that exploit organophilic membrane technology to be simulated in detail and rigorously optimised. This will be used in future research work to further reduce energy requirements within the chemical and petrochemical industries.

**References:**

- [1] Drumm C., Busch, J., Dietrich, W., Eickmans, J., Jupke, A, 2013.: STRUCTese – Energy efficiency management for the process industry. Chemical Engineering and Processing 67.
- [2] Drumm C., 2014: Energy Efficiency Management: Energieeffizienz-Management und -Benchmarking für die Prozessindustrie, Projekt im Rahmen der Fördermaßnahme: Technologien für Nachhaltigkeit und Klimaschutz – chemische Prozesse und stoffliche Nutzung von CO<sub>2</sub>. Schlussbericht zum BMBF Vorhaben, DOI: 10.2314/GBV:835910318, TIB, Hannover.

## 3.11 HY-SILP – Entwicklung von neuartigen, ressourcenschonenden HYdroformylierungstechnologien unter Einsatz von Supported Ionic Liquid Phase (SILP) Katalysatoren

BMBF Project FKZ 033RC1107

Project Coordinator: Dr. Hanna Hahn, Evonik Industries AG

Project Partner: Friedrich-Alexander-Universität Erlangen-Nürnberg, Technische Universität Darmstadt

### 3.11.1 Introduction

Hydroformylation is one of the most important homogeneously catalysed reactions in the chemical industry. The reaction involves the conversion of olefins, carbon monoxide and hydrogen on transition metal complexes to produce linear and branched aldehydes (see Figure 100).

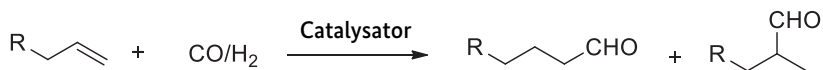

Aldehydes are important intermediates in the petrochemical value-creation chain and find use, for example, in the synthesis of plasticisers. The production capacity of these 'oxo products' is several tens of millions of metric tons per year. [1] Hydroformylation is thus an industrially relevant process in the chemical value chain and is currently one of the few large-scale homogeneously catalysed processes used in the production of bulk chemicals. The crucial factors that generally determine the cost efficiency of a homogeneously catalysed process are separating and recovering the catalyst and preventing the formation of secondary products. Using coordinating ligands can significantly increase the activity and selectivity of a homogeneous catalyst under relatively mild reaction conditions. Disadvantages of homogenous catalysis are the high catalyst costs and the complexity of separating the products from the catalyst. In heterogeneous catalysis, loss of catalyst and the costs that this entails are far lower than in homogeneous catalysis and the catalyst can usually be used for longer periods before needing to be replaced. However, heterogeneous catalysts typically exhibit lower chemoselectivity and regioselectivity. Immobilising the homogenous catalysts used in hydroformylation would enable the advantages of homogeneous and heter-

Fig.100: Hydroformylation of olefins to yield linear and branched aldehydes

ogeneous catalysis to be combined to create a new resource-efficient hydroformylation technology. This would not only achieve faster conversion rates, but also improve selectivity and could potentially dispense with the need for a number of product workup procedures. This could reduce the energy requirements of the overall process, which would generate economic benefits as well as being environmentally advantageous. Although many catalysts are often made from expensive components, the improved yields and energy savings achievable through immobilisation can, when combined with a well-designed process, result in a significantly reduced production costs for a particular product. This is a particularly important factor in large-scale industrial chemical production processes. One of the most promising immobilisation concepts is that of Supported Ionic Liquid Phase (SILP) catalyst systems.

### 3.11.2 Project description

The goal of the HY-SILP project was to develop novel, resource efficient immobilisation concepts for hydroformylation catalysts using ionic liquids (Supported Ionic Liquid Phase (SILP) catalyst systems, see Figure 101).

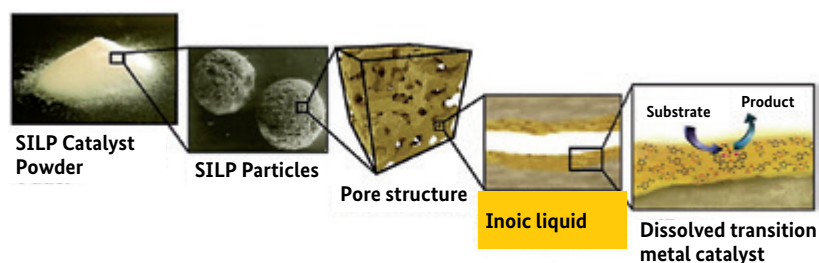

Fig. 101:  
The functional structure  
of a SILP catalyst

The homogeneous transition metal complex is dissolved in a non-volatile ionic liquid and the resulting solution is then applied to a porous carrier material. The catalyst powder contains the individual solid SILP particles. The porous structure of the carrier material is coated with an ionic liquid in which the transition metal complex is dissolved. The result is a defined catalyst complex that exhibits high activity and selectivity. As is the case with a conventional homogeneous catalyst, modifications can be achieved relatively simply by altering the ligand design. On the macroscopic scale, the catalyst is either in the form of a pourable powder or a coated solid body, which facilitates the separation of catalyst and product thus reducing the complexity of the overall process. There is no longer any need to use solvents to dissolve the ligands. Compared to conventional solvents, ionic liquids have the advantage that they have effectively no vapour pressure and they also exhibit physical and chemical coordination properties. The substrates dissolve from

the gas phase into the liquid salt where they are converted on the catalyst. The product then vaporises from the non-volatile salt film.

This allows a homogeneously catalysed reaction to be carried out in a conventional solid bed reactor and removes the need for process stages that involve providing, separating or recovering a solvent for the homogeneous catalyst. The result is a significant saving of energy and thus reduced carbon emissions.

The HY-SILP project was split into different work packages that were carried out by the project partners (Evonik Industries AG, Prof. Wasserscheid – Friedrich-Alexander University Erlangen-Nuremberg (FAU), Prof. Claus – TU Darmstadt):

- Virtual screening of ionic liquids for SILP hydroformylation systems
- New high-performance ligands for SILP hydroformylation
- Variation of carrier materials, ionic liquids and ligands
- Study of IL-filled carrier materials
- Formal kinetics of the SILP reaction system
- Microkinetic and macrokinetic investigations of the SILP systems
- Process engineering studies
- Examination of deactivated SILP systems and recycling of precious metal components
- Long-term stability and economic feasibility analysis.

Virtual screening of the ionic liquids (ILs) and the ligands was carried out in order to match the performance of the catalyst with the solvent properties of the ILs. Promising candidates were then synthesised and validated. The ionic liquids and ligands selected for study were used to synthesise the SILP catalysts and the systems were then optimised.

As part of the collaborative project, technically relevant SILP catalysts for the rhodium-catalysed hydroformylation of olefins were developed. The focus was on the long-term stability of the systems. In addition to catalyst development work, kinetic studies were also performed and the results of these studies used to develop a reaction model and to configure and dimen-

sion the overall process. The deactivated SILP systems were analysed and recycling concepts for recovering the transition metals from the deactivated SILP catalysts were developed.

### 3.11.3 Results

As a result of the HY-SILP project, it was possible to identify the performance-limiting factors in SILP catalysis. The main factors are the available phase boundary surface as a function of loading and IL, and the pore size distribution within the SILP carrier material.

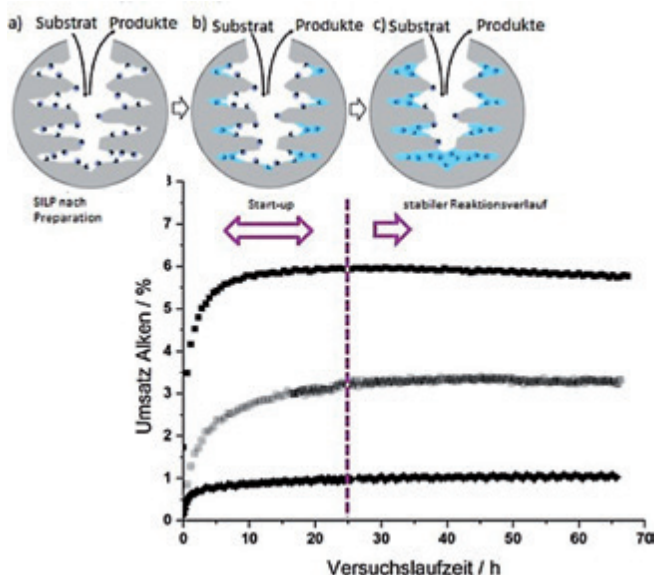

Fig. 102: SILP pore loading before and during the reaction; Progress of reaction as a function of different carrier materials used in the SILP system [2]

The extent of pore loading in the SILP system and its effect on the start-up behaviour of the hydroformylation reaction are shown in Figure 102 [2–4]. In the prepared SILP system, the transition metal catalyst is physisorbed on the pore surface prior to reaction. Under the prevailing reaction conditions the aldehydes generated can form high concentrations of aldol as a result

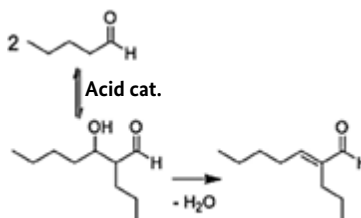
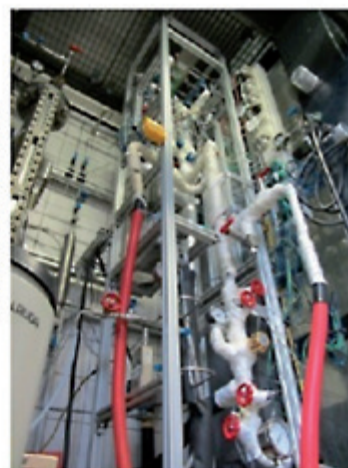
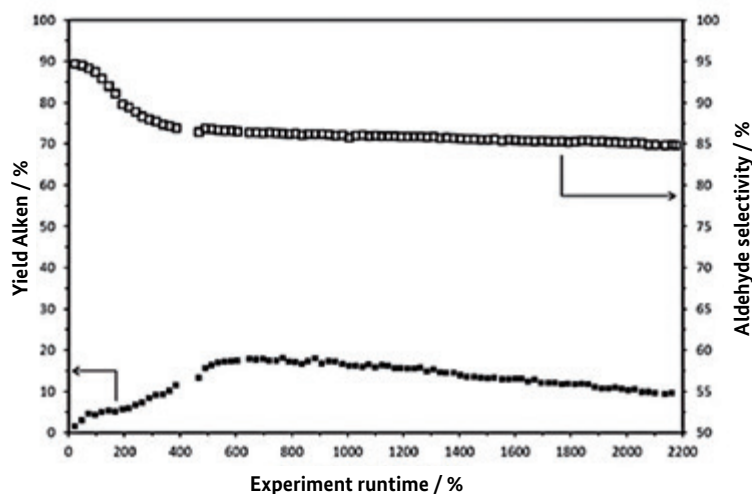

Fig. 103: Example of a secondary reaction in which the aldehydes initially formed react further to produce higher-boiling aldol condensates

of thermal catalysis or catalysis occurring at acid centres in the carrier material, as shown in Figure 103. Capillary action means that these secondary products are retained in the small pores of the SILP system. The start-up behaviour of the system therefore depends on the characteristics of the carrier material. Ultimately, the reaction enters a stationary state in which the pores of the SILP system are filled.

To counteract the deactivation of the SILP catalyst caused by the accumulation of high-boiling secondary products, the ionic liquid needs to be a good solvent for the catalyst and a poor solvent for the main product and for the secondary products. The ligands must also exhibit high selectivity and activity and be matched to the ionic liquid being used. COSMO-RS methods were successfully developed within the HY-SILP project and were used to determine the activity coefficients of non-ionic liquids [5]. Progress was also made on predicting the solubility of ionic liquids. From a class of about 100 ligand structure types, 10 were identified as having good solubility in ionic liquids. Ligands possessing fragments of annular aromatic structures tended to show good solubility. New ligand structures were synthesised and successfully used in the hydroformylation reaction. A benzopinacol ligand system in a SILP catalyst was shown to be stable over a period of more than 2000 h and exhibited an average selectivity of about 85% for the linear aldehydes (see Figure 104). The economic feasibility analysis identified potential CO<sub>2</sub> savings of 2.3% through the implementation of an additional SILP reactor in the existing hydroformylation process.

Fig. 104: Results of long-term studies of hydroformylation with SILP catalysts (left) and the associated test facility in an industrial technical centre (right)



### 3.11.4 Exploitation, commercialisation and dissemination of results

The HY-SILP project produced a deeper and lasting understanding of supported ionic liquid phase (SILP) catalyst systems and identified the weaknesses of this type of technology. The unexpectedly strong formation of high-boiling components through aldol condensation of the aldehyde products makes direct commercial application of the HY-SILP process uneconomical. However, it was also found that the selective separation of the aldehyde product from the catalyst centre represented a very promising optimisation of this new technology. This approach has been studied since September 2015 within the EU-funded project **ROME**O – **R**ector **O**ptimisation by **M**embrane **E**nhanced **O**peration, which is part of the Contractual Public-Private Partnership (cPPP) ‘Sustainable Process Industries and Resource Efficiency’ (SPIRE). In addition to Evonik Industries AG, Linde AG, Friedrich-Alexander University Erlangen-Nuremberg (FAU) and RWTH Aachen University, the consortium also includes other experts in the fields of catalysis, membrane processes and reactor technology in Germany, Austria, Denmark, Spain and Belgium.

The results of the HY-SILP project are therefore being directly used as the foundation for the ongoing ROME O project, in which the focus is not just on the large-scale hydroformylation process, but also on the industrially significant water-gas shift reaction. The goal is to develop an innovative reactor concept for homogeneously catalysed gas-phase reactions that combines both the reactive and material separation stages (see Figure 6). By combining two unit operations in this way, energy savings of up to 78% and emission reductions of 90% can be achieved in the case of hydroformylation.

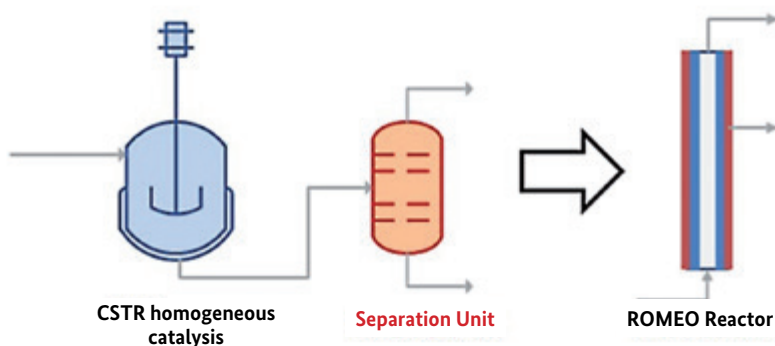

Fig. 105:  
The aim of the EU project ROME O is to develop an innovative reactor model for homogeneously catalysed gas-phase reactions



**References:**

- [1] A. Börner, R. Franke, *Hydroformylation. Fundamentals, Processes, and Applications in Organic Synthesis*, Vol. 2, Wiley-VCH, Weinheim, 2016, S. 677
- [2] A. Schönweiz, J. Debuschewitz, S. Walter, R. Wölfel, H. Hahn, K. M. Dybala, R. Franke, M. Haumann, P. Wasserscheid, *ChemCatChem* 2013, 5, 2955 – 2963.
- [3] Supported Ionic Liquid Phase (SILP) materials in hydroformylation catalysis. A. Schönweiz, R. Franke in *Supported Ionic Liquids – Fundamentals and Applications* (Eds.: R. Fehrmann, A. Riisager, M. Haumann), Wiley-VCH, Weinheim, 2014.
- [4] A. Kaftan, A. Schönweiz, I. Nikiforidis, W. Hieringer, K. M. Dybala, R. Franke, A. Görling, J. Libuda, P. Wasserscheid, M. Laurin, M. Haumann, *Journal of Catalysis* 2015, 321, 32–38.
- [3] R. Franke, B. Hannebauer, S. Jung, *Fluid Phase Equilibria* 2013, 340, 11–14.

## 3.12 InReff – Integrated Resource Efficiency for Reducing Climate Impacts in the Chemical Industry<sup>1</sup>

BMBF Project FKZ 033RC1111

Project Coordinator: Dr. Nicolas Denz, ifu Hamburg GmbH

Project Partner: Sachtleben Chemie GmbH, Technische Universität Braunschweig, Hochschule Pforzheim, H.C. Starck GmbH

### 3.12.1 Introduction<sup>2</sup>

Many of the approaches that have been adopted to reduce emissions of climatically relevant greenhouse gases have focused on reducing the consumption of fossil fuels and minimising a system's energy requirements. However, in the process industries, where large quantities of other resources and materials are consumed and converted in complex production systems, such an approach can be overly restrictive. For example, it is important to take account of the energy requirements and greenhouse gas emissions associated with supplying the necessary raw materials and feedstock. The type of comprehensive analysis that this requires is provided by existing methodologies, such as the life cycle assessment method as set out, for example, in the ISO 14040 standard (2006) or the carbon footprint approach that is based on the GHG Protocol (2004). As many of the climatically relevant production processes are coupled to material flow streams, extensive analysis of the entire production system is required and not just of the energy generating and supply structures. From a climate protection perspective, increased resource efficiency with respect to both energy resources and material feedstocks is therefore an important production strategy.

It may at first sight appear puzzling that economically beneficial savings remain unused – savings that would result in a reduction of the quantities of energy and materials used and thus reduce the associated costs and greenhouse gas emissions. Closer analysis, however, reveals a number of reasons why this is the case (Görlach & Zvezdov, 2010). In complex production systems, one often cited reason is that suitable analytical instruments are either unavailable or are not used. Today's chemical industry does indeed have ac-

<sup>1</sup> This article presents a summary of the main content presented in the final project report.

<sup>2</sup> This section was taken from the original project proposal.

cess to highly advanced process engineering tools and these are used to assist in achieving the core objective of continuously increasing the efficiency with which materials, energy and infrastructural resources are used. However, the optimisation work carried out up until now has been restricted to very specific questions and applications and to tightly defined production facilities. What is missing is a more general, higher level modelling platform with which targets such as reducing greenhouse gas emissions or improving resource efficiency can be addressed in a more integrated and comprehensive framework. From a methodological vantage point, this is clearly not a trivial exercise, as expert knowledge from a range of different fields and disciplines and at different levels of detail need to be incorporated.

Increasing the resource efficiency of a production system and the associated reduction in environmental burdens and climate impact will be achievable when the quantitative relationships between the measures to be implemented, the cost and effort associated with their implementation and their impact on the climate and the environment can be formulated. It is also essential that life cycle assessments are incorporated as early as possible into the conceptual engineering phase as this is the period in which key process design decisions are made (Heinze & Hungerbühler, 1997).

### 3.12.2 Projektbeschreibung<sup>3</sup>

The goal of the InReff project was to develop an IT-based modelling and analysis environment that can provide comprehensive answers to a wide range of questions relating to resource efficiency and climate protection issues in the chemical industry. The key components of the project were developing and integrating existing concepts and methods, software prototyping, and case-study research and knowledge transfer. The work was carried out collaboratively among a consortium consisting of three industrial partners (H.C. Starck GmbH, Huntsman PA Germany, Worlée Chemie GmbH), two academic partners (Institute of Industrial Ecology at Pforzheim University of Applied Sciences and the Institute of Chemical and Thermal Process Engineering at Braunschweig University of Technology), a software solutions provider (ifu Hamburg GmbH) and a number of other companies as associate project members (including BASF SE and Chemstations Europe GmbH). To achieve its objectives, the project combined established methods of designing and developing processes, such as flow sheet simulation, heat integration analysis, material flow modelling, material flow cost account-

---

<sup>3</sup> The first paragraph in this section was taken from the original project proposal. The remaining paragraphs are a slightly revised version of the publication (Viere et al. 2015) expanded to include Figure 106.

ing, life cycle analysis, process simulation and optimisation (see Figure 106). At the research level, this approach demanded detailed subject-specific expertise coupled with the ability to collaborate and develop interdisciplinary solutions.

Energy and material flow analysis (Möller, 2000) is the key element of the process model and forms the basis for evaluation and optimisation. The analysis involves calculating energy and mass balances for the materials and energy flowing into and out of processes, production units, chemical plants or entire production networks and their interrelationships. This requires the acquisition of input/output data, for example from measurements, calculations, estimates or from the use of generic data. The energy and material flow analysis forms the basis for the following tools that are used in resource efficiency analyses.

Life cycle assessments (LCA) are used to quantify and communicate (both within and between companies) possible environmental impacts, e.g. by calculating product-specific, process-specific or site-specific greenhouse gas balances, and they support the process of deciding how best to achieve stipulated environmental goals (see, for example, ISO 14040, 2006; GHG Proto-

Fig. 106: Diagram summarising the approach and methodology adopted for integrated resource efficiency analysis

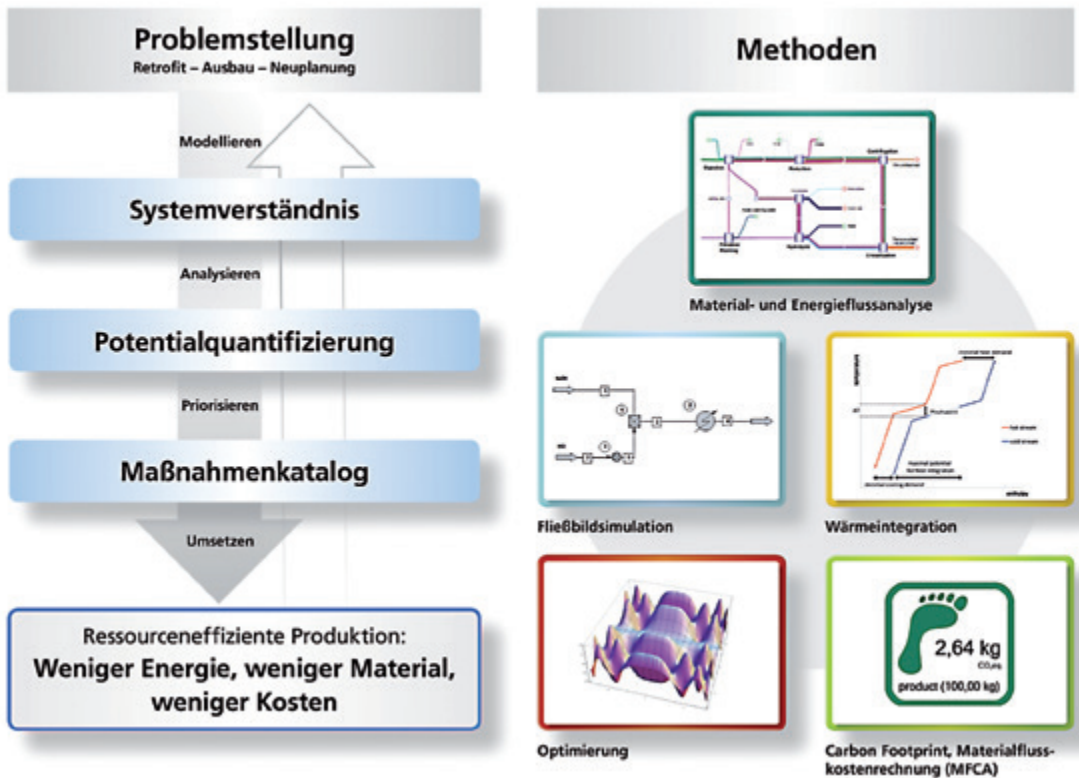

col, 2004). Standardised LCA databases such as ecoinvent<sup>4</sup> provide generic datasets that cover such common elements as the supply and disposal of materials, the provision of fuels for heating or transport processes.

Computer-aided process engineering (CAPE) provides an integrated platform of IT tools that are frequently used during the process design and process development phases (see, for instance, Beßling, Lohe, Schoenmakers, Scholl & Staatz, 1997). A central element of CAPE is flow sheet simulation. Thermodynamic calculations are used to compile consistent mass and energy balances that can be used to estimate costs and to assist process measurement and control tasks. One of the most important prerequisites for the integration of CAPE tools is a simple-to-use and generally accepted user interface that facilitates the transfer of data to other resource efficiency applications.

Heat integration methods are used to identify potential energy savings by linking heat sources and heat sinks within a production system. A well-known approach to heat integration is pinch analysis (see e.g. Linnhoff & Hindmarsh, 1983). Heating and cooling are both energy-intensive processes whose efficiency can be significantly improved through heat integration. Measures of this kind can help to reduce the climate impact and fossil-fuel requirements of industrial processes.

Material flow cost accounting (MFCA) as described in ISO 14051 (2011) is based on energy and material flow analyses and enables a transparent representation of the costs caused by inefficiencies and material losses. The purchase price of 'lost' material, the process and energy costs incurred up to the point when the loss occurs, and the loss-related write-off for plants and equipment are assigned to the waste streams. In material flow cost accounting, these costs represent the starting point for identifying potential savings by reducing or avoiding waste streams and material losses.

The overall assessment of all the measures taken is carried out using the process and performance indicators specified in the scope of the analysis. Once this has been done, simulation-based optimisation can be carried out in order to determine the best possible combination of parameters or measures that will ensure a more resource-efficient production process. The resource-efficiency analysis concludes with the implementation of the measures and a subsequent performance review, which themselves represent the starting point for a continuous improvement strategy for existing or planned production processes or production sites.

### 3.12.3 Results

In summary, the research and development work set out in the project proposal was carried out successfully by the project partners. From a methodological perspective, a broad-based concept for integrated resource efficiency analysis was developed in which integration is achieved primarily by modelling the relevant material flow networks. Based on this concept, a prototype infrastructure for methodological integration was created using the software platform Umberto NXT<sup>5</sup> developed by ifu GmbH of Hamburg.

Application-independent interfaces were designed for the modelling platform for the set of process analysis methods identified above and were then implemented using common software tools (e.g. the flow sheet simulation software CHEMCAD<sup>6</sup>, the heat integration software PinCH<sup>7</sup> and the optimisation tool Lingo<sup>8</sup>). This interface development work established a very positive collaboration between ifu Hamburg and the suppliers of specialist process engineering software that has continued beyond the InReff project.

Following multiple iterations, the software tools were adapted to create prototype add-ons (CHEM-CAD Connector, Heat Integration Connector and Optimizer) that were used during the project period by the partners in the process industry. The data acquired using the special process software tools can then be transferred back to the modelling platform, where it can be processed and analysed further using methods such as LCA or MFCA and can be visualised by means of Sankey diagrams. These software tools therefore support the overall aim of creating a comprehensive, broad-based approach to resource-efficiency analysis.

One interesting byproduct from the materials flow optimisation work should also be mentioned: the prototype tool 'Optimizer' already enables mathematical optimisation problems to be specified interactively in graphical form. In addition to its value in resource efficiency analysis, this modelling approach may help to increase levels of acceptance of mathematical optimisation methods among industrial users.

In addition to the software engineering results, the realworld case studies offered the opportunity to gain experience in providing resource efficiency and sustainability advisory services and enabled specific areas of improvement to be identified. For example, the modelling of a stacked ring dryer at Huntsman P&A Germany indicated that energy consumption could be reduced by 18%, which is equivalent to reducing carbon emissions by about 1000 metric tons of CO<sub>2</sub> per year. Applying the optimisation tool to the tungsten production operations at H.C. Starck GmbH showed that emissions

could be reduced by up to 15,000 t CO<sub>2</sub>-eq. or 6.3% of current levels without requiring any change in the product portfolio.<sup>9</sup>

### 3.12.4 Exploitation, commercialisation and dissemination of results

The results from the project are enabling companies, particularly those in the SME sector, to address the issue of resource efficiency and to identify and exploit potential means of reducing resource consumption and thus contribute to the industry-wide drive toward greater sustainability.

As things stand at present, the methods and software prototypes developed in the project offer an excellent basis for future commercial development. The prototype tools CHEMCAD Connector, Heat Integration Connector and Optimizer are currently being implemented as add-ons for the standard sustainable engineering software package Umberto NXT. The next stage will involve evaluating these add-ons in individual customer projects so that they can be further improved before being launched on the market. The ultimate aim is to make this new technology accessible as commercially available software products. The cooperation established between the industrial project partners during the InReff project looks set to continue in future.

Initial experience with the methodologies developed during the project has generated very positive feedback. For ifu Hamburg GmbH, the results and experience acquired during the project will enable the company to expand its portfolio to give more weight to resource efficiency consulting, particularly for customers in the chemical industry. From a scientific and academic point of view, the methodological developments and the project results produced over the course of the project been published in conference proceedings and scientific journals and this looks set to continue once the project has ended. The methodological developments will form the basis for further research activity. Selected research results have, for instance, already been incorporated into the module 'Introduction to Industrial Ecology', which is taught at Pforzheim University of Applied Science.

### References:

- Beßling, B.; Lohe, B.; Schoenmakers, H.; Scholl, S. & Staatz, H. (1997). CAPE in Process Design - Potenzial and Limitations. *Comp. & Chem. Eng.*, 21(1), 17-21.
- GHG Protocol (2004). The Greenhouse Gas Protocol. A Corporate Accounting and Reporting Standard. Washington D.C.: WRI/WBCSD.
- Görlach, S. & Zvezdov, D. (2010): Material- und Ressourceneffizienz (MaRes): Maßnahmenvorschläge zur Ressourcenpolitik im Bereich unternehmensnaher Instrumente: Feinanalysepapier für den Bereich Public Efficiency Awareness & Performance. Wuppertal-Institut.
- Heinzle, E. & Hungerbühler, K. (1997): Integrated process development. The key to future production of chemicals. *Chimia* 51 (5), 176-183.
- ISO 14040 (2006). Environmental Management - Life Cycle Assessment - Principles and Framework. Genf: ISO.
- ISO 14051 (2011). Environmental Management - Material Flow Cost Accounting - General Frame-work. Genf: ISO.
- Linnhoff, B. & Hindmarsh, E. (1983). The Pinch Design Method for Heat Exchanger Networks. *Chemical Engineering Science*, 38(5), 745-763.
- Möller, A. (2000). Grundlagen stoffstrombasierter Betrieblicher Umweltinformationssysteme. Bochum: Projekt.
- Viere, T., Hottenroth, H., Lambrecht, H., Paschetag, A., Rötzer, N., Scholl, S.; Wesche, M. (2015): Operationalisierung von Nachhaltigkeit im Produktionskontext: Integrierte Ressourceneffizienzanalyse zur Senkung der Klimabelastung von Produktionsstandorten der chemischen Industrie. In: Leal Filho, W. (Hrsg.): *Forschung für Nachhaltigkeit an deutschen Hochschulen*. Springer Fachmedien Wiesbaden: 349-363.
- 4 <http://www.ecoinvent.org>, retrieved 31 March 2015
- 5 <http://www.umberto.de>, retrieved 8 Feb. 2016
- 6 <http://www.chemstations.eu>, retrieved 8 Feb. 2016
- 7 <http://pinch-analyse.ch/index.php/de>, retrieved 30 Nov. 2015
- 8 <http://www.lindo.com>, retrieved 8 Feb. 2016
- 9 Whether emission reductions of this magnitude can be achieved in practice must still be verified, as a number of constraints were neglected in the material flow model.



## 3.13 Multi-Phase – Increased energy efficiency and reduced greenhouse gas emissions through use of multi-scale modelling of multi-phase reactors

BMBF Project FKZ 033RC1102

Project Coordinator: Dr. Marc Becker, Evonik Industries AG

Project Partner: BRUKER OPTIK GMBH, Eurotechnica GmbH, ILA Intelligent Laser Applications GmbH, PreSens Precision Sensing GmbH, Helmholtz-Zentrum Dresden-Rossendorf e.V., Ruhr-Universität Bochum, TU Hamburg-Harburg

### 3.13.1 Introduction

The production of basic chemicals and their industrial-scale processing in chemical and biochemical manufacturing facilities frequently involves liquids in which a gas and/or liquid or solid phase is dispersed. Designing multi-phase reactors is a complicated undertaking due to the complexity of the interplay between the hydrodynamics, kinetics, and mass and heat transfer processes occurring in the system. So far it has not been possible to provide a complete numerical description of such a system at an industrially relevant scale. Besides the amount of computing power needed to handle these large mathematical models, another limiting factor is the availability of validated models for simulating the different phenomena involved. Most of the literature is limited to descriptions of aqueous multi-phase systems with air as the dispersed phase. The model equations derived in such work are not applicable to the typical industrial reaction systems that take place in organic media and at elevated temperatures and pressures. To address these issues, three main goals were defined for the project.

1. Develop models and methods for designing, or enhancing the design of, multi-phase plant equipment.
2. Develop appropriate measurement techniques to generate the experimental data needed to build such models.
3. Use a pilot-scale test reactor at Evonik Industries AG to evaluate the measurement techniques and to generate the measurement data (Figure 107).

The measurement techniques have now been developed and thoroughly tested at the pilot reactor at Evonik Industries (Figure 108). The results are being used to identify, validate and improve suitable computational models. The experimental data and computational models have been archived in a web-accessible database. Other project work packages will be looking at the potential for CO<sub>2</sub> mitigation in a sample industrial process. The improved design methodology for multi-phase reactors is also being implemented in CFD code.

The improvements in multi-phase reactor design achieved during the project have generated significant economic benefits by reducing greenhouse gas emissions and conserving resources. In addition, the project has gener-

Fig. 107:  
Pressurised bubble column  
reactor at a technical centre  
operated by Evonik  
Industries AG



Fig. 108:  
Testing a laser endoscope used  
for determining bubble size



ated the knowledge and expertise that German companies need to maintain a competitive advantage in the global marketplace and help ensure job security at home. The collaborative networking between academic and industrial project partners has also encouraged intensive information sharing in both directions. The results continue to be disseminated at conferences and in trade and academic journals. Another positive aspect of the Multi-Phase project has been the opportunity it provided to encourage the development of young engineering talent by offering students work placement assignments and internships and the opportunity to undertake undergraduate and graduate-level research projects.

## 3.14 IL-WIND – Development of IL-based lubricants for wind turbines

BMBF Project FKZ 033RC1009

Project Coordinator: Prof. Dr. P. Wasserscheid, Friedrich-Alexander-Universität Erlangen-Nürnberg  
Lehrstuhl für Chemische Reaktionstechnik

Project Partner: Merck KGaA, Schaeffler Technologies GmbH & Co. KG, Friedrich-Alexander-Universität Erlangen-Nürnberg

### 3.14.1 Project goal

As the power ratings of wind turbines continues to increase, the components and subsystems within them are having to withstand ever greater levels of mechanical stress. The rolling bearings are particularly susceptible to failure, which is often caused by inadequate lubrication. The primary failure



mechanism causes damage to the material microstructure resulting in early failure. This significantly reduces the availability and thus the economic and environmental benefits of the wind turbines, which in turn has a negative impact on the overall carbon balance.

The goal of the IL Wind project is to develop high-performance lubricants that are based on ionic liquids (ILs) and capable of reducing susceptibility to damage. The resulting rise in system availability significantly increases the economic and environmental benefits of wind power generation, particularly in the case of multi-megawatt turbines.

The consortium partners took responsibility for different aspects of the overall development effort. The University of Erlangen-Nuremberg addressed the fundamental theoretical and engineering issues; technical implementation was managed by the industrial partners Merck and Schaeffler Technologies, with the end user Senvion S.A. (formerly REpower Systems SE) providing advisory services.

### 3.14.2 Project status

The research team on the IL WIND project developed halogen-free ionic liquids (ILs) with a target solubility of 5 wt% in petroleum-based oil and evaluated their thermal properties. COSMO-RS was used to identify the required structural elements of the ILs. The tribological properties (friction and wear surfaces) of the ILs in contact with 100Cr6 steel in air, argon and CO<sub>2</sub> atmospheres were measured and compared with standard oils. The corrosion behaviour of the ILs was also examined using six different metals and alloys.



The researchers also conducted screening trials to demonstrate the tribological suitability of the structures for subsequent trials of rolling bearings. A test bed was set up that enabled the details of the damage mechanism to be studied in situ using IR spectroscopy.

The trials on the rolling-element bearings carried out at Schaeffler demonstrated that the

IL additive was effective at preventing damage. Adding just 1% of the IL to a low reference oil resulted in a four-fold increase in the runtime to failure. Subsequent lubrication tests were carried out to provide further confirmation of the basic tribological properties of the new lubricant prior to Merck scaling up production of the formulation to 1000 litres. This quantity was sufficient to run an extended test campaign on large bearings. Testing was halted after 3000 hours with no bearing damage detected. The trials demonstrated the fundamental suitability of the bearing lubricant and its potential to prevent damage to the bearings.

### 3.14.3 Exploitation, commercialisation and dissemination of results

Early bearing failure reduces the availability of wind turbines to supply carbon-free power and thus diminishes the expected environmental and economic benefits. The excellent tribological properties and intrinsic conductivity of the lubricant with IL additive that was developed during the IL WIND project can mitigate the bearing failure mechanism and prevent turbine downtime. There is therefore less need to use conventional fossil-based fuel to compensate for the loss in wind power generating capacity.

Further field verification trials will be performed on existing wind turbines with the aim of continuing development of the lubricant through to market introduction.

None of the results achieved in this project would have been possible without the productive collaboration between the academic and industrial partners. A total of ten Bachelor's theses, four Master's theses and four doctoral dissertations were completed during the IL Wind project.

## 3.15 SIT – Utilization of low-calorific industrial heat by means of sorption heat pump systems using ionic liquids and thermochemical accumulators

BMBF Project FKZ 033RC1002

Project Coordination: Dr. Jens Busse, Evonik Industries AG

Project Partner: Friedrich-Alexander-Universität Erlangen-Nürnberg, Deutsches Zentrum für Luft- und Raumfahrt e.V. (DLR), GasKlima GmbH

### 3.15.1 Project goals and content

Large quantities of heat are constantly being released by German industry into the surroundings without being used, either because the temperature of the waste heat stream is too low or there is no use for the heat at the time it is available. Over the last few decades, heat integration technology has been introduced at integrated production sites, particularly those in the chemical industry, with the result that the energy efficiency of production processes has been increased to the point where further improvement will only be possible with the introduction of innovative technology.

Additional heat flows can only be utilised if the temperature can be increased to a useable level with the aid of a heat pump. High-density chemical heat storage media can be used to store the higher-temperature heat and make it available on demand in the form of thermal energy, significantly reducing primary energy consumption and greenhouse gas emissions.

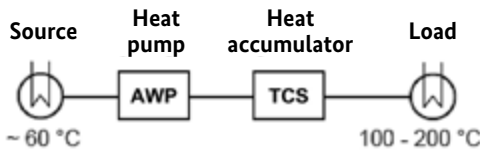

Fig. 109:  
Scenario for utilising low-calorie industrial waste heat

Novel pairs of working fluids based on ionic liquids are currently being developed for use with absorption heat pumps. Tailoring suitable ternary working fluid pairings can boost overall performance and can create advantages compared to the conventional working fluid pairings that have been used



so far. Process engineering assessment and validation are carried out using pilot-scale heat pumps as well as commercially available heat pumps.

In order to develop a thermochemical heat storage system with high energy storage density, work is underway to identify and evaluate suitable reaction systems. A reactor design is also being developed which will be optimised for these materials and is suitable for this type of combined heat pump and heat storage system. Successful development of a pilot-scale heat storage system will provide the basis for commercial upscaling at a later date.

### 3.15.2 Project status

The project ended on 31 October 2013. Two working fluid pairings were identified for use in absorption heat pump systems, each of which is suitable for a different temperature range. The systems were used successfully in demonstration-scale and in commercially available absorption heat pump systems. A life cycle analysis of the production of a working fluid pair based on ionic liquids based was carried out and showed that the novel working fluid pair is more resource- and energy-efficient than conventional working fluid pairings. Possible storage media were evaluated for use in thermochemical storage systems, and lab-scale testing was carried out on one such material that was identified as a potentially viable candidate. The project team also identified and tested numerous reactor designs for thermochemical heat storage. Important findings from the project are now underpinning



Fig. 110:  
Chemical heat storage  
test system  
(Source: DLR e.V.)



further work developing pilot-scale thermochemical storage systems. A carbon footprint estimate derived from the research results provides a basis for gauging possible reductions in CO<sub>2</sub> emissions and resource consumption.

### 3.15.3 Exploitation, commercialisation and dissemination of results

In 2007, industrial sites in Germany alone generated an annual waste heat potential of 406 TWh. Exploiting this potential could decrease primary energy consumption, lower greenhouse gas emissions and reduce costs, giving German industry a competitive advantage and ensuring sustainable growth. The development of thermochemical storage systems is still at an early stage and it is not yet possible to operate an absorption heat pump and heat storage system in combination at the pilot scale. The work carried out during the project did however demonstrate that this technology could create opportunities to reduce carbon emissions. Close collaboration between university research organisations and industrial partners created opportunities to align innovative research with application-related needs. The SIT project provided an excellent opportunity for research work by engineering and science students, with a total of four doctoral dissertations and numerous Bachelor's and Master's theses completed over the course of the project.



## 4 Methodological Guidance on Implementing Carbon Accounting Mechanisms for Processes in the Chemical Industry

Horst Fehrenbach, Axel Liebich, Jonas Harth, Nabil Abdallah, Andreas Detzel, Balint Simon, Thomas Fröhlich, Jürgen Giegrich  
ifeu – Institut für Energie- und Umweltforschung Heidelberg GmbH

### 4.1 Background and objectives

The resolutions passed at the UN Climate Change Conference in Paris in December 2015 officially entered into force on 4 November 2016. This event has triggered a ‘historic turning point for climate action’ and the German government ‘*will be strongly advocating swift and ambitious implementation of the Paris Agreement*’.<sup>1</sup> The implementation of these goals, however, poses

Decarbonisation –  
A climate policy imperative

<sup>1</sup> Press release from the Federal Ministry for the Environment, Nature Conservation, Building and Nuclear Safety (BMUB) of 3 November 2016  
<http://www.bmub.bund.de/themen/klima-energie/klimaschutz/>

major challenges. In fact achieving the stated objectives means nothing less than the complete decarbonisation of our materials-based economy in the second half of the 21st century, i.e. a highly developed industrial society with zero carbon emissions. Germany is committed to reducing greenhouse gas (GHG) emissions by at least 40% of its 1990 levels by the year 2020. The goal for 2050 is to have reduced emissions by 80–95%.

Decarbonisation will not only require innovative developments in technology and infrastructure, but also changes in consumer behaviour. The challenges faced by a chemical industry predominantly based on fossil feedstocks are almost as great as those facing the transport and energy sectors. All of these industries therefore have to lower their reliance on petroleum, natural gas and coal significantly. If these fossil resources are considered purely as fuels, this goal appears feasible given the alternative sources of renewable energy now becoming available. However, access to photovoltaic systems or wind power provides few benefits to companies in materials-based industries, i.e. to companies that process raw materials, as they will need to find sources of alternative non-petroleum-based feedstock. The emergence of the bioeconomy and renewable raw materials initially appeared to offer a solution. However, discussions on land use and land-use change have not only highlighted the limits of this potential solution, but have also identified carbon accounting issues that need to be addressed.

Such discussions cannot be conducted without reliable data on the greenhouse gas intensities of products and their life cycles, and of services or even entire policy areas. Carbon accounting and carbon footprinting are now firmly established instruments used for assessment and evaluation purposes and for assisting decisionmaking in government, business and society at

Carbon footprint – A policy benchmark at all levels

Fig. 111: Roadmap for greenhouse gases based on the German government's climate and energy policies

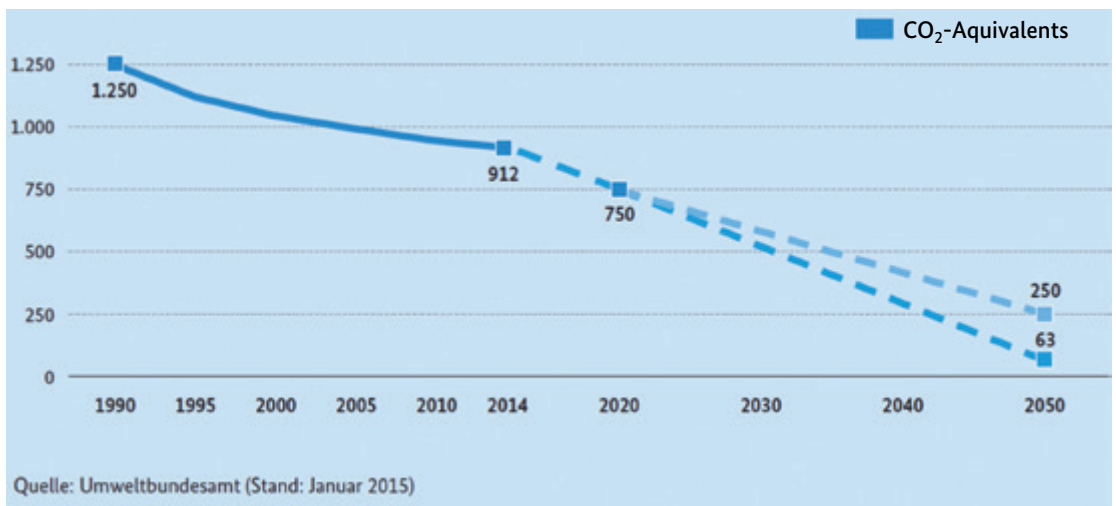

CO<sub>2</sub> – From environmental enemy No. 1 to universal feedstock

large. They have become mainstream tools for communicating environmental and sustainability issues. The obligation to compile national greenhouse gas (GHG) inventories in accordance with the Kyoto Protocol has led to the creation of comprehensive databases that have been created using harmonised methodologies (IPCC 1996). The EU Renewable Energy Directive (2009/28/EC) and the Fuel Quality Directive (2009/30/EG) assume that the actual contribution of transport biofuels towards achieving mandatory GHG emissions targets can be computed and they specify the calculation methods to be used.

One of the most innovative current approaches is concerned with transforming carbon dioxide (CO<sub>2</sub>) from an environmental 'evil' (greenhouse gas) into an environmental 'asset' (raw material). This would effectively solve both problems in a single step. This approach is currently referred to by a range of different names, of which Power-to-Liquid (PtL) is just one of the more commonly used. In the jargon of EU law, reference is to 'renewable liquid and gaseous transport fuels of non-biological origin' (Directive (EU) 2015/1513) that can also be used as chemical feedstock. These products are regarded as 'renewable' because the underlying concept assumes they will be manufactured using renewable electricity, which will at times be available in excess quantities due to the rapid increase in the amounts of renewable electricity in European grids. Autonomous solar farms in sunny regions are also being discussed. The renewable electric power is used to generate hydrogen that can then be combined with CO<sub>2</sub> (or other carbon sources) using established processes to custom synthesise the required hydrocarbon precursors. Although originally regarded as a secondary issue, the question of where the CO<sub>2</sub> should come from is now of central significance.

Carbon accounting for CO<sub>2</sub> utilisation processes

The question of how to calculate the carbon footprint of hydrocarbon products synthesised from CO<sub>2</sub> (from where?) using (renewable?) electricity is far more complex than it might seem at first sight. This therefore is the central issue to be addressed in this report, and this will be done principally by presenting a synopsis of relevant standards and specific methodological proposals. The analysis will highlight those methods that are generally accepted as standard and identify those that are still the subject of debate among experts or that have not been examined in detail.

In addition to the specifications and requirements already mentioned, those published by the IPCC, the EU Commission and those contained in ISO standards are accepted and uncontroversial. But methodological discrepancies exist even between these main reference documents and these differences will be discussed in what follows. The specific problems that arise when attempting to actually compile life cycle inventories of systems that utilise chemically converted CO<sub>2</sub> are often only inadequately addressed in these broader general standards.

Additional assistance is sometimes available in the guidance and methodological proposals issued by industrial stakeholders or can be found in current academic publications in the field. Given the complex nature of the systems studied, these publications typically do not represent a consensus of expert opinion but they can provide useful input in helping to develop a consensus in future.

This report is designed to be a practical guide that brings together accepted rules and principles and any amendments deemed appropriate and necessary thus establishing a transparent and reliable basis for life cycle inventory (LCI) analysis and evaluation. Case studies are frequently referenced to demonstrate and illustrate the concepts being presented.

A word or two first about the terminology used. The field is already awash with numerous terms and acronyms, some of which are regarded as synonymous or that overlap one another in terms of meaning. The assumption that the utilisation of CO<sub>2</sub> as a raw material is primarily a means of chemically storing excess electricity has led to widespread use of the terms ‘power-to-liquid’ (PtL) and ‘power-to-gas’ (PtG). The more general catchall abbreviation PtX has also been introduced. When the focus is on capturing CO<sub>2</sub> for chemical conversion, the abbreviations most commonly seen are: CCU, which stands for ‘carbon capture and use’ (or ‘utilisation’) and CCR, which stands for ‘carbon capture and replacement’ (or ‘recycling’). The two abbreviations are understood to mean essentially the same thing and are synonymous with the abbreviation CDU (‘carbon dioxide use’), which has also been used by some authors. For the sake of simplicity, the abbreviation CCU will be used in this report to refer to any system or technology in which CO<sub>2</sub> is separated from an industrial or energy-related source and used in the synthesis of new products. It therefore covers the use of CO<sub>2</sub> for the production of fuels and chemical feedstocks.

## 4.2 Special features of carbon accounting in carbon capture and utilisation systems

What is it about CCU technology that makes computing a carbon footprint so complicated? At first glance, we are dealing with a life cycle like any other. Raw materials are processed into a product by consuming energy and other input materials, the product is then used for its intended purpose, eventually reaching the end of its service life. This is the general description of a life cycle analysis (LCA) and provides an established framework for modelling the life cycle inventory (LCI) data. There are, however, always difficult detailed questions to answer, but this is common to most LCAs.

The aim of this report

Terminology

The questions that need to be addressed when undertaking carbon accounting for CCU technologies are somewhat more complex. These questions can be formulated as we proceed along the cradle-to-grave chain:

#### 4.2.1 Where does the CO<sub>2</sub> come from?

The simplest case in carbon accounting terms, but by far the most expensive approach in economic terms, is that in which the CO<sub>2</sub> is extracted like any other natural resource from the environment (here, the atmosphere). But questions immediately arise: Does this removal from the atmosphere represent a sink? Should this be modelled right from the start as a ‘negative emission’?

A more economical approach would be to make use of a gas that has already been collected and that contains a higher concentration of CO<sub>2</sub>. However, this raises even more questions. What process does the gas come from? How should the gas collection step be accounted for, i.e. where does one draw the boundary between the preceding system that generated the CO<sub>2</sub> and that in which the CO<sub>2</sub> is utilised? What was the source of the CO<sub>2</sub>, was it of biological, fossil or mineral origin? How would the source of the CO<sub>2</sub> influence the product being synthesised from it? This last question is directly related to the third block of questions (see below).

#### 4.2.2 What needs to be taken into account when modelling the chemical synthesis stage?

Here too the question of how best to delineate the process that utilises the CO<sub>2</sub> from the preceding CO<sub>2</sub>-supply process is paramount. The issue of delineation may be closely related to the process chain associated with chemical synthesis, so that the boundaries need to be precisely defined and justified. The key questions here are: At what stage does the system boundary for the CCU process begin and what criteria are used in deciding where the boundary is located? When is it necessary for the system boundaries to encompass the CO<sub>2</sub>-supply process, i.e. the entire upstream CO<sub>2</sub> chain?

Additional synthesis-related questions focus on the other important component used to create a ‘renewable’ product from the CO<sub>2</sub>: the provision of electricity to generate hydrogen by hydrolysis. The entire concept is based on the assumption not only that this electricity is from a renewable source, but that it is excess electric power not drawn from the general supply grid. RES electricity cannot be associated with the chemical synthesis stage unless this assumption is made. The hydrogen can, admittedly, be supplied from other sources (e.g. low calorific value (LCV) gas). In such cases, the origin and any necessary incorporation of upstream processes need to be carried out in a manner analogous to that described above for CO<sub>2</sub>.

Obviously, all of the other standard rules have to be observed when calculating the carbon footprint of the synthesis stage, e.g. the consistency of the functional unit (how is it defined?) with the system boundary. An important aspect in this regard is how possible co-products are handled. Does an allocation method need to be used or do credits have to be issued?

### 4.2.3 What role is played by the product's final use or end-of-life scenario?

There are numerous areas of use for the hydrocarbon products generated from waste CO<sub>2</sub>. From the perspective of the EU's stated targets, PtL products are not only interesting as advanced transport fuels (see above), they are also seen as critical in achieving specified climate goals (see, for example, (UBA 2013) and the Federal Climate Action Plan (BMUB 2016)) relating to the residual long-term demand for liquid fuels (e.g. aviation fuels). When the CO<sub>2</sub>-derived product is used as a fuel, the CO<sub>2</sub> will be immediately rereleased.

If, on the other hand, a product derived from CO<sub>2</sub> is used as a material, this raises the question of the product's lifetime. In products with a long lifetime, the carbon dioxide is effectively stored in the product, which for very long storage periods may be relevant in terms of climate accounting. In extreme cases, the CO<sub>2</sub> may be permanently sequestered. If the product lifetime needs to be taken into account, there need to be clear rules about how this is done. This also brings us back to the issue of the origin of the CO<sub>2</sub>, as it once

Fig. 112:  
The fundamental building blocks when compiling a carbon inventory for a CCU system

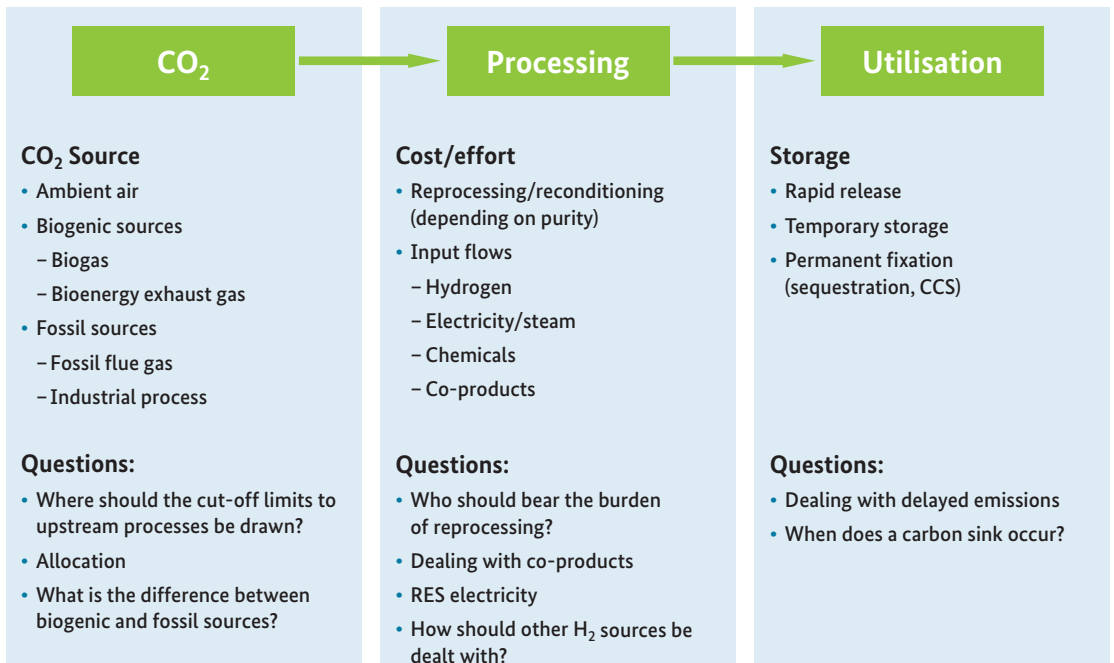

again raises the question of whether the CO<sub>2</sub> was biological or non-biological in origin and what this means in terms of the overall carbon footprint.

## 4.3 Overview of life cycle inventory methodologies and assessment rules

Irrespective of the ‘special’ methodological issues of CO<sub>2</sub> accounting referred to above, computing a carbon footprint is based on a set of fundamental rules. In this section we identify the main reference documents and provide an overview of the basic life cycle inventory methodologies and assessment rules, all of which are accepted by experts in the field. The aim is to show the basic elements that constitute generally accepted good practice in the accounting methodologies used to compile carbon footprints.

We will also use this opportunity to analyse the documents for any details they offer regarding answers to the questions referred to earlier.

### 4.3.1 Relevant documents

#### 4.3.1.1 Statutory requirements

EU directives

With the amendments to the EU’s biofuels policy introduced in Council Directive (EU) 2015/1513, PtL (or PtX) technologies are now included in the new generation of biofuels for transport being promoted. This makes it necessary to calculate the carbon emission savings that can be achieved with these transport fuels. Council Directive (EU) 2015/652 presents default values for the ‘life cycle greenhouse gas intensity’ of individual fuel production pathways but does not offer any specific calculation methods. It seems likely that this task will be assigned to the Joint Research Centre (JRC), which has recently issued initial proposals regarding the principles for calculating emissions from these fuels. These will be described in more detail below in the section on suggestions from academic sources.

The default values presented in Council Directive (EU) 2015/652 for ‘Fuels of non-biological origin’ cover the following electrofuel production pathways:

- Compressed synthetic methane via the Sabatier reaction using hydrogen from non-biological renewable energy electrolysis.
- Compressed hydrogen using electricity from three alternative sources (RES electricity, coal, coal with CCS)

The default value for synthetic methane is given as 3.3 g CO<sub>2</sub>-eq/MJ making



synthetic methane the electrofuel with the lowest greenhouse gas intensity and representing emissions savings of more than 96% relative to petrol or diesel. If coal is used as the raw material source (for hydrogen), the life cycle GHG intensity rises to 230 g CO<sub>2</sub>-eq/MJ, which represents the opposite record.

The value of the GHG emission intensity specified for the electrofuel 'synthetic methane' supports the view expressed in Council Directive (EU) 2015/1513 that the use of a synthetic transport fuel of non-biological origin (PtX) is to be considered as emissions-free as that of a biofuel. These statutory provisions therefore effectively dictate that the CO<sub>2</sub> emissions avoided at the original source should continue to be assigned to that source.

The transposition of these EU Directives into German law is currently under preparation. The subject of how to treat 'electrofuels' is addressed in the draft discussion document for the 37<sup>th</sup> Ordinance for the Implementation of the Federal Immission Control Act

(BImSchV) dated 19 August 2016. The document essentially implements the requirements set out in the EU directives and, like the directives, contains no concrete specifications on calculation methods. From the list of production pathways included in the EU directives, the Ordinance focuses on the 'electrofuels' mentioned above.

The supplementary guidelines issued by the EU Commission (2015) on calculating GHG emissions for biofuels under the Renewable Energy Directive (RED) include guidance on quantifying emissions savings in CO<sub>2</sub> capture scenarios such as carbon capture and replacement (eccr) and carbon capture and geological storage (eccs). The guidelines clearly state that a bonus for CCR technology is only admissible if it can be demonstrated that the utilisation of the CO<sub>2</sub> replaces some other necessary production of this CO<sub>2</sub> from fossil sources.

#### 4.3.1.2 Standards

The **life cycle assessment (LCA)** is effectively the established methodology for assessing all of the environmental impacts associated with a product's life cycle. The underlying principles of the methodology are standardised in ISO 14040/14044. While these standards offer flexibility in many areas when designing an LCA, they also include a set of clearly defined rules that are regarded as being internationally recognised and accepted. Key specifications are:

- Formulating a precisely defined goal and defining the scope of the study to achieve that objective. Put another way: Pose the right question and use an appropriate approach to answer it.

Transposition in national law

EU guidelines on carbon capture

LCA standard  
ISO 14040/14044

- The system boundaries, which define the processes to be included in the analysis of the product, typically cover the entire product life cycle ('cradle-to-grave') though the study can be limited to certain sections of the life cycle if this compatible with the goal and scope of the study.
- A life cycle assessment is a relative approach structured around a functional unit to which all statements and calculations relate.
- LCAs must only be used to make comparisons between things that can be meaningfully compared. If two systems to be compared lead to different impacts, they have to be harmonised, for example by system expansion (one way of doing this is to issue credits).

Overall, the LCA methodology chosen must be transparent and must be consistent with the specified goal and scope. This is particularly important when allocations are made. Allocations become necessary when a process or system generates more than one product output or when co-products or residues from other product systems are used as input materials.

The Technical Specification ISO/TS 14067 on quantifying **carbon footprints of products** (CFP) is based on the approach set out in the LCA standard ISO 14040/44. A CFP is essentially nothing more than an LCA that focuses on the impact category greenhouse gas effect. However, ISO/TS 14067 provides more concrete methodological guidance on those aspects specifically relevant to calculating a carbon inventory and includes a more detailed treatment of GHG emissions and removals than that given in ISO 14040/44.

For example, ISO/TS 14067 requires that fossil and biogenic carbon sources be treated separately (6.4.9.2), which is essentially the same as requiring that biogenic CO<sub>2</sub> should always be included in the analysis. If a biological system removes CO<sub>2</sub> from the atmosphere (e.g. through the growth of biomass), this would be accounted for as a 'negative emission' at the beginning of the product's life cycle that counters the later positive emission (release of CO<sub>2</sub>) at the end of the life cycle. In such cases the carbon balance for such biogenic sources is zero. However, if the final emission does not occur (permanent removal), the negative emission remains and the net carbon balance would be characterised as a carbon sink.

In carbon accounting terms, the technical removal of CO<sub>2</sub> from the atmosphere behaves like the biological system that ISO/TS 14067 is concerned with. So the accounting method specified in ISO/TS 14067 can also be applied to technical systems.

Although the Technical Specifications do not (yet) represent a binding ISO standard, the specifications have been subject to broad international discussion and agreement and can therefore be considered to represent accepted principles.

An additional internationally implemented methodology of greenhouse gas accounting is the Clean Development Mechanism (CDM). CDM is used in climate protection projects. The underlying principle involves defining a reference scenario for the emissions mitigation project, a scenario referred to as the project baseline. For emission reductions to be certified under the CDM, they must demonstrate ‘additionality’. Emission reductions are calculated as the baseline emissions (i.e. those that would have occurred without the project) minus the emissions of the project.

The CDM Methodology Booklet published by the CDM Executive Board contains approved methodologies for particular project types. The Booklet includes two types of project in which CO<sub>2</sub> is used as a substitute for CO<sub>2</sub> from a fossil source; in the one case the CO<sub>2</sub> is from a biogenic source, in the other from tail gas.<sup>1</sup> Differentiating between CO<sub>2</sub> from biogenic and from fossil sources is of central significance in these examples. The option of including a carbon sink is also considered. However, the CDM approach differs from other GHG accounting systems in that it focuses on projects and not products. The focus in the CDM approach is on the additionality of the project relative to the baseline. The system boundaries therefore also include the upstream CO<sub>2</sub> generation process. In contrast to calculating the carbon footprint of a product, the CDM approach does not have to treat the problem of allocation between the two systems ‘CO<sub>2</sub> generation’ and ‘CO<sub>2</sub> utilisation’. On the other hand, the CDM methodologies provide no assistance in carrying out product-focused LCI.

#### 4.3.1.3 Proposals from industry

The Greenhouse Gas Protocol was launched in 1998 on the initiative of the oil and gas company BP as an accounting tool to assist companies in calculating their greenhouse gas emissions. This has since been developed by WRI and WBCSD (2008) into a product life cycle accounting and reporting standard designed to enable companies in the manufacturing industries to compute the carbon emissions and removals associated with a product life cycle. The underlying principles assume a full value chain approach to GHG

CDM methods (UNFCCC)

GHG Protocol Corporate  
Standard developed by WRI  
and WBCSD

1 ‘Substitution of CO<sub>2</sub> from fossil or mineral origin by CO<sub>2</sub> from renewable sources in the production of inorganic compounds’, ‘Recovery of CO<sub>2</sub> from tail gas in industrial facilities to substitute the use of fossil fuels for production of CO<sub>2</sub>.’

accounting as set out in the GHG Protocol Scope 3 Standard<sup>2</sup> using an ‘attributional’ accounting approach. The methodological requirements are to a large extent similar to those of the ISO standards mentioned above.

The implementation details for the GHG Protocol Standard provide very clear and comprehensible guidance on best practice for GHG accounting at the product level. Particularly detailed information is provided on treating the subjects of recycling and allocation, as well as on land use and the separate analysis of biogenic and fossil sources of carbon. The GHG Protocol issued by WRI and WBCSD also provides a number of useful clarifications, such as that regarding the generally agreed rule that double counting of emissions must be strictly avoided. WRI and WBCSD also take a firm position on other aspects that are the subject of significant debate among experts, particularly the exclusion of:

- ‘offsets’, i.e. carbon credits that accrue from the ‘purchased’ emission reductions (e.g. through emissions trading or RES-E certificates). While this is the general consensus within the LCA community, it should be formulated explicitly as an internationally recognised rule.
- weighting factors for delayed emissions, as products with long lifetimes only release CO<sub>2</sub> (e.g. through energy recovery) many years later. There is therefore a wish to include this ‘time benefit’ into GHG accounting procedures. This approach has been rejected by WRI and WBCSD. However, the topic continues to be the subject of controversial discussion among experts.

#### PlasticsEurope

Since the mid 1990s, PlasticsEurope – the association of the European plastics industry – has been regularly publishing what it refers to as the ‘eco-profiles’ of different plastics and precursors. The methodological basis for analysing the life cycle of plastics from ‘cradle’ (oil and gas extraction) to ‘factory gate’ is provided in the document ‘Eco-profiles and Environmental Declarations’ (PlasticsEurope 2011). The use of CO<sub>2</sub> as a feedstock is not explicitly treated in the document but the procedures specified for treating secondary raw materials can also be applied to the situation with CO<sub>2</sub>. The secondary raw materials enter the system with burdens arising from their collection, sorting and conversion, but not with burdens from any processes prior to their original production.<sup>3</sup>

<sup>2</sup> Scope 1 of the GHG Protocol describes all direct GHG emissions including emissions from combustion in owned or controlled plants or equipment,

Scope 2 accounts for GHG emissions associated with purchased energy (e.g. electricity, district heating); Scope 2 emissions physically occur at the facility where the energy is generated,

Scope 3 covers indirect emissions, e.g. from services provided by third parties or from the production of purchased materials; Scope 3 also enables product-specific GHG inventories to be compiled.

<sup>3</sup> „Secondary raw materials enter the system with burdens due to collection, sorting and conversion of pre- and post-consumer plastic wastes.“

If open-loop recycling is carried out, i.e. if burdens have to be assigned between the primary and the secondary life cycle, PlasticsEurope stipulates that the 50:50 rule be adopted as a default.<sup>4</sup>

### 4.3.2 Fundamental rules

On the basis of what has been presented so far, we can compile the following set of fundamental rules representing good and generally accepted practice in carbon accounting.

The greenhouse gases considered in the accounting system should always include the list of GHGs specified in the Kyoto Protocol, but should also incorporate the most recent recommendations from the IPCC. That means that at present (IPCC 2013) indirect GHGs (NO<sub>x</sub> etc.), soot and albedo effects should not be taken into account.

Impacts should be characterised in a consistent way based on the most recent global warming potential (GWP) factors. Exceptions are permissible if specific applications explicitly prescribe the use of other GWP factors, e.g. the Renewable Energy Directive (Council Directive 2009/28/EC) requires the use of GWP factors from IPCC 2001 for transport biofuels. A time horizon of 100 years is used to calculate the GWPs.

The life cycle inventories (LCIs) of biogenic and non-biogenic sources should be calculated separately. It must be clear what is being treated as an emission and what is regarded as a removal. Emissions from land-use changes must be incorporated wherever there is a direct link to the production pathway.

The functional unit and the system boundary must be precisely defined. If only certain sections of the life cycle are being considered (e.g. cradle to gate), the limits that this places on the conclusions that can be drawn from the study must be communicated.

The precise definition of the system boundary automatically produces a sharp delineation between coupled systems. Clear allocation rules must be observed. Both ISO 14044 and ISO/TS 14067 recommend that allocations should be avoided and that system expansion is preferable. However, system expansion also results in the expansion of the functional unit making it more difficult to derive results pertaining strictly to one specific product. For this reason, allocations are unavoidable in many cases. When addressing questions concerning CO<sub>2</sub> utilisation, the primary issue is that of defining

Which greenhouse gases are included?

GWP factors

Biogenic and non-biogenic sources

Functional unit and system boundary

System allocation

<sup>4</sup> 'In case of open-loop recycling, when assigning burdens to primary and secondary life cycles, the 50:50 rule should be adopted as a default.'

Process allocation  
or credits

the system boundary with respect to possible upstream processes (e.g. an industrial process whose CO<sub>2</sub> emissions are captured). The generally accepted rules require a consistent and transparent approach that is based on engineering and physicochemical principles. In cases where such principles are not readily applied, allocation on the basis of economic value (e.g. market price) may be used.

The same question arises for multifunctional processes in which the product at the centre of the life cycle inventory analysis (reference product) is produced together with other coproducts. Allocation means the partitioning of all process burdens (including the upstream process chain) among all of the coproducts. Here too the ISO-specified hierarchy of approaches applies – with the same limitations. The preferred approach of system expansion is often interpreted in terms of ‘avoided burdens’ or ‘credits’. In this approach, allocation is circumvented by issuing credits (negative emissions) for each coproduct whose production was avoided. Consider the case in which electricity is produced as a coproduct. As the emissions normally associated with generating this amount of electricity conventionally were avoided, the avoided environmental burden is issued as a credit. In this approach, therefore, the multifunctionality is credited completely to the reference product. Such an approach is justifiable provided that the reference product can be shown to be the (economic) driver for the production of all coproducts.

The alternative approaches of ‘complex allocation’ and ‘avoided burden credits’ are also discussed by experts in the field in terms of the following two models:

- ‘Attributional LCA’: Focuses on the inherent properties (attributes like mass, heat content, market price, etc.) of the materials produced and the use of these properties for allocation purposes.
- ‘Consequential LCA’: Focuses on a defined main product and one or more coproducts. As the existence of the coproducts is regarded as a consequence of the production of the main product, the benefits associated with them are treated as credit assigned to the main product.

Besides the fact that there is still no internationally recognised definition of either term, detailed discussion of all relevant related aspects would be beyond the scope of this report. We simply note at this point that thus far there is no professional consensus regarding the ‘right’ approach to take on this issue. Whichever method is chosen, it is critical that it agrees with the overarching LCA principles of correspondence with the stated goal, consistency and transparency.

It is clear from the above that the group of accepted rules for creating carbon footprints is not sufficient to provide answers to the specific questions raised in Section 2 regarding the creation of LCI datasets for production systems involving CO<sub>2</sub> utilisation. The following section therefore analyses a number of other potentially suitable proposals.

### 4.3.3 Suggestions from academic sources

Of the methodological problems raised in Section 2, there is still no generally accepted approach to answering the following questions:

- What criteria should be used to define the boundary to upstream processes that supply CO<sub>2</sub>?
- What approach should be used to deal with co-production (multifunctional) scenarios?
- What steps should be taken when analysing coupled processes, such as those in open-loop or closed-loop recycling systems.
- Under what conditions may RES electricity be taken into account when computing GHG emissions?
- How should the temporary storage of carbon be handled in long-life products?

To address these issues, the following publications were analysed: JRC (2016) – a working paper from the Joint Research Centre that examines the GHG intensities of novel fuels within the RED framework; JRC (2010) – Guidance on the ILCD Handbook; and papers by von der Assen et al. (2013, 2013a).

#### 4.3.3.1 Joint Research Centre (JRC)

The decision to incorporate PtX products as advanced transport fuels within the regulatory scope of the Renewable Energy Directive (2009/28/EC) and the Fuel Quality Directive 2009/30/EC (see 4.3.1.1) means that the annexes to the RED and the FQD must also now include methodological rules for these new production pathways. The JRC has published some initial proposals for discussion among experts. Of those core questions of relevance in the present report, the JRC has addressed:

- the origin of the CO<sub>2</sub>
- permanent storage
- the question of if and how electricity used as the energy source for transport fuels should be incorporated in calculating GHG intensities.

Origin of the CO<sub>2</sub>

Beyond that, the JRC refers to the rules used to calculate the typical and default GHG impacts for transport biofuels set out in Annex V to the RED.

The proposals relating to CO<sub>2</sub> as an input material focus on whether the supply is regarded as ‘elastic’ or ‘rigid’. An elastic system is one in which the supply of the input material is flexible and can be expanded to meet increased demand. JRC cites cultivated biomass as an example of an elastic system, though CO<sub>2</sub> from the atmosphere would, in principle, also fit the definition. The example given for a ‘rigid source of supply’ is blast furnace gas, which as a by-product of the steelmaking process cannot be generated in greater quantity even if demand for it were to increase. Differentiating between elastic and rigid supplies provides a means of assigning the burdens associated with an upstream process (in this case, the blast furnace process) to the input material (CO<sub>2</sub> or other carbon compounds in the blast furnace gas). If the supply is elastic, the provision of the input material is always assigned to the process that utilises the CO<sub>2</sub>. If the supply is rigid, the question arises as to how best to allocate GHG emissions between the main system and the upstream supply process. JRC recommends a common sense approach, i.e. one that does not prescribe rigid allocation rules that may well not be applicable in all cases.

The blast furnace gas example is itself a special case in that it is a fuel, though not a particularly energyrich one, and it contains other gases in addition to CO<sub>2</sub>. If the blast furnace gas is used as feedstock in a chemical synthesis process, it can no longer serve as a source of energy for the upstream (steelmaking) process and the JRC therefore recommends attaching an energy burden to the chemical synthesis process.

According to JRC recommendations, the CO<sub>2</sub> emissions burden remains associated, at least in this particular case, with the upstream process (the blast furnace) and is therefore not assigned to the product (e.g. the transport fuel) synthesised from the input CO<sub>2</sub> when the fuel is burned at the end of its life.

The situation is quite different if the CO<sub>2</sub> used to synthesise the transport fuel was purchased as a specially produced industrial gas for further processing. The CO<sub>2</sub> is only burden-free for the chemical processing system if its production was technically unavoidable.

Permanent storage  
(carbon capture and  
storage)

If carbon is permanently stored at the end of a product’s useful life (e.g. CCS), this will be included in the process model as a carbon sink minus those emissions associated with supplying the energy needed for the storage operation. However, the JRC does not explain how to differentiate in this regard between biogenic and fossil sources of CO<sub>2</sub>. There is also no information on



whether and to what extent the upstream process (blast furnace or biomass cultivation and use) should be incorporated.

According to the JRC, an average national or European electricity mix should be used when assessing GHG emissions. The possibility of including renewable electricity in the assessment depends, according to the JRC, on the EU Commission issuing binding specifications in this regard, which are expected by the end of 2017.

#### 4.3.3.2 ILCD Handbook

The ILCD Handbook (JRC 2010), which was compiled by the JRC on behalf of the EU Commission, is an oft-cited reference for detailed methodological questions about implementing LCAs in both a European and broader international context. It provides practical guidance for conducting LCAs and establishes a foundation for ensuring the quality and consistency of life cycle inventory data, methods and analyses and aims to promote methodological convergence.

With respect to GHG accounting in systems in which CO<sub>2</sub> is utilised, the ILCD Handbook is of particular value for the information it provides on drawing system boundaries, on incorporating removals and on dealing with biogenic carbon.

According to the ILCD Handbook, characterisation factors for the impact assessment are assigned to removals and emissions alike. This means that the uptake of CO<sub>2</sub> should be incorporated in the accounting process as a negative emission. The uptake of CO<sub>2</sub> by plants is included in the LCI as 'resources from air'. Even though not mentioned explicitly, it seems reasonable to adopt an analogous approach for direct CO<sub>2</sub> capture from ambient air. To ensure methodological clarity and ease of communication, the release of CO<sub>2</sub> and CH<sub>4</sub> from biological sources should be treated separately.

The ILCD Handbook also addresses how the sort of temporary CO<sub>2</sub> storage that may arise through CO<sub>2</sub> utilisation can be included in carbon accounting procedures. The standard approach is defined as the conventional analysis based on GWP and a fixed time horizon. Temporary carbon storage is only considered quantitatively if this is explicitly required by the specified goal of the LCA study. In such cases, a delayed emission correction of 0.01 kg CO<sub>2</sub> is assumed for every kilogram of stored CO<sub>2</sub> per year. For example, if 1 kg of CO<sub>2</sub> is bound in a plastic material and if this material is burned in a waste incinerator 20 years later releasing the CO<sub>2</sub>, then the carbon emissions should be reduced by 0.2 kg of CO<sub>2</sub> (1 kg CO<sub>2</sub> x 20 yr x 0.01/yr).

Electricity

Temporary CO<sub>2</sub> storage

Accounting procedures for carbon removals and biogenic sources of carbon

Temporary CO<sub>2</sub> storage

Boundaries between systems

Annex C to the ILCD Handbook is concerned with the modelling of reuse, recycling and energy recovery from the perspective of the end-of-life product that is to be reused, recycled or subject to energy recovery. The question of where to draw the system boundary between the first (primary) life cycle and subsequent life cycles developed from end-of-life products has been answered by the JRC as follows:

- The key indicator is the market value of the end-of-life product.
- If the market value is positive (i.e. greater than zero), the end-of-life product is regarded as a co-product of the preceding process or system.
- If the market value is negative (i.e. less than zero), the end-of-life product is classified as waste whose treatment is assigned to the system that generated the waste until such time that the waste treatment process generates a (secondary) product or commodity with a positive market value.

The critical issue therefore becomes that of defining the precise location of the boundary that determines how environmental burdens are assigned between the primary life cycle and the life cycle of the secondary product.

A material that is categorised as waste must not carry over into a subsequent life cycle any burden from the previous waste-generating life cycle. The boundary between the life cycles is that point at which the secondary product or commodity generated from the waste passes the 'zero market value' threshold. This is illustrated in Figure 113, which is from the ILCD Handbook and shows an example of how post-consumer waste might be allocated.

Fig. 113: Allocation of waste when waste treatment yields a secondary product or commodity with a market value: The flow inventory for process P<sub>n</sub>, during which the waste material passes across the 'zero market value' threshold (MV < 0 to MV ≥ 0), is apportioned by allocating the encircled input and output flows (emissions, waste flows, co-products and consumables) to the '1<sup>st</sup> and 2<sup>nd</sup> (product) systems'.

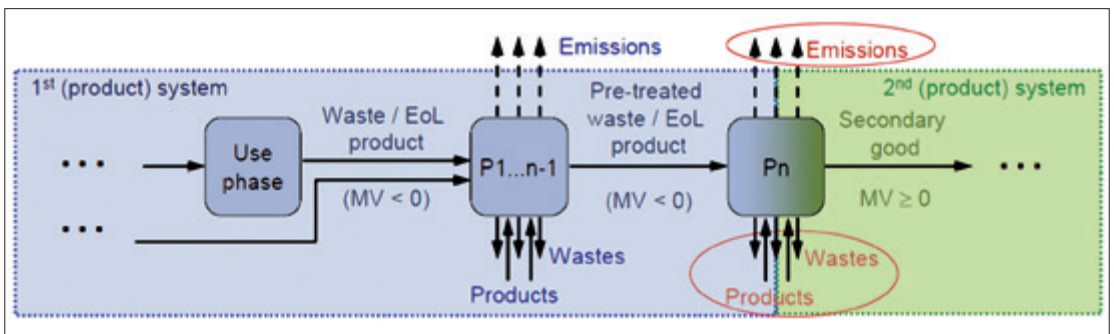

When applied to the use of CO<sub>2</sub> generated as 'production waste' from an upstream process (e.g. a power plant or ammonia production unit) there are two possible cases to consider:

- Case 1: The CO<sub>2</sub> has a negative market value. No environmental burden from the up-stream process is applied to the system that utilises the CO<sub>2</sub>.

- Case 2: The CO<sub>2</sub> has a positive market value. Environmental burdens from the upstream process are assigned to the system in which CO<sub>2</sub> is utilised.
  - If the positive market value is achieved once a specific intermediate step (e.g. a purification stage) has been performed, the upstream chain will need to be incorporated up until the point at which the market value becomes positive.
  - If the CO<sub>2</sub> with positive market value is obtained directly from a multifunctional process, the JRC recommends that allocation is carried out in the conventional way on the basis of physical or other criteria.

If the CO<sub>2</sub> was specifically produced for the CO<sub>2</sub> utilisation stage, it does not have waste status and is fully assigned to the CO<sub>2</sub> utilisation stage.

On the subject of multifunctional processes, the ILCD Handbook provides comprehensive details on how to implement the specifications in the ISO 14044 standard. At this point we only wish to focus on one particular scenario discussed in the ILCD Handbook, namely the allocation procedure recommended for the Haber-Bosch synthesis of ammonia using natural gas that has undergone steam reforming. The CO<sub>2</sub> produced is classified as a co-product provided that it is captured and used in a subsequent production step (the example in the Handbook is that the CO<sub>2</sub> is used for the production of urea). The Handbook works through the process of allocating burdens between ammonia and CO<sub>2</sub>. Nevertheless, one needs to ask whether these are the correct products for the allocation procedure, as the steam reforming process yields CO<sub>2</sub> as a co-product of H<sub>2</sub> and the CO<sub>2</sub> is not involved at all in the subsequent Haber-Bosch synthesis stage (N<sub>2</sub> + H<sub>2</sub>).

Co-products

#### 4.3.3.3 PAS 2050 - Publicly Available Standard 2050:2011

As the first published standard to provide a method for quantifying life cycle GHG emissions of products, there was considerable interest in the British standard PAS 2050 when it was first issued in 2008. It originated in an initiative of the British Carbon Trust and DEFRA<sup>6</sup> and was published by the BSI<sup>7</sup> as a national standard. A revised version was issued in 2011.

PAS 2050 does not explicitly discuss CO<sub>2</sub> utilisation as it is discussed in this report, but it does contain a number of specifications that are relevant in this context. In addition to some fundamental, less contentious recommendations, PAS 2050 also provides methods for handling co-products, for including biogenic carbon in the LCI, and for incorporating delayed emissions of GHGs.

<sup>6</sup> UK Department for Environment, Food and Rural Affairs

<sup>7</sup> British Standards Institute.

Dealing with  
co-products

PAS 2050:2011 recommends the following hierarchy for dealing with co-products:

1. System expansion: Expansion of product system to include all additional functions related to the co-products in order to avoid allocation. As the PAS 2050 standard focuses on the calculation of product-specific results, the system expansion is implemented in the form of credit for avoided burdens.
2. Additional specifications: For certain questions, PAS 2050 specifies additional explicit requirements.
3. Allocation: Partitioning of GHG emissions between the different products in proportion to their economic value.

However, the PAS 2050 standard does not define when an output flow should be considered a product and when it should be identified as waste. The proposal for allocation based on economic value could be understood to mean that the typical interpretation applies, namely, that output flows with a positive market value are defined as co-products.

Biogenic CO<sub>2</sub> / Fossil CO<sub>2</sub>  
Assessment of temporary  
carbon storage

To take account of temporary carbon storage, particularly in relation to biogenic sources of carbon, the PAS 2050 standard states that the life cycle GHG emissions of a product should be assessed on the basis of a 100-year assessment period. This also applies to biological carbon sequestration. The only exception is that for human food and animal feed. Stored CO<sub>2</sub> that will not be completely released within the assessment period is regarded as permanently stored.

PAS 2050 specifies that the latest GWP100 factors are to be used as characterisation factors. Although PAS 2050 has no default mechanism for taking temporary carbon storage into account, it does define an optional methodology using weighting factors that can be used to quantify the effect of delayed emissions.

Electricity

To take renewable electricity generation into account instead of the usual grid-average electricity mix, PAS 2050 (2011) requires that the following two conditions are met:

1. Electricity generated from a renewable energy source (RES) may only be used by a single company or organisation.
2. The RES electricity used must not be part of the average national electricity mix. A residual electricity mix is therefore required.

Both requirements can be summarised by the statement that double-counting of low-emissions benefits arising from the use of RES electricity must be avoided.

#### 4.3.3.4 Von der Assen

Von der Assen has published numerous papers on life cycle assessment methodologies for carbon capture and utilisation, which he refers to as 'LCA of CCU' (von der Assen et al. 2013a, 2013b, 2014, 2016). As part of the research programme 'Technologies for Sustainability and Climate Protection – Chemical Processes and Use of CO<sub>2</sub>', von der Assen, in collaboration with Bayer, carried out a life cycle assessment of the production of polyols using CO<sub>2</sub> as feedstock that was captured from a lignite-powered power plant (von der Assen/Bardow 2014). The polyols themselves were processed further to produce polyurethanes. In two earlier publications, von der Assen addressed in detail methodological aspects of life cycle assessments of CO<sub>2</sub> use (von der Assen et al. 2013a, 2013b). He identified the fundamental methodological challenges that arise when attempting to undertake GHG emissions accounting for production systems that use CO<sub>2</sub>. A summary of his key proposals is provided below.

Von der Assen concurs with Rabl et al. (2007) and recommends the explicit inclusion of all CO<sub>2</sub> emissions and removals associated with each stage of the life cycle. This means that the direct removal of CO<sub>2</sub> from ambient air by carbon capture technologies or by photo-synthesis will generate a GHG emission credit (negative emissions).

The removal of CO<sub>2</sub> from flue gas streams is treated differently, however, as this is not an elementary flow but an economic flow. An elementary flow is a flow between the techno-sphere and the natural environment, whereas an economic flow is a flow that always remains within the technosphere. In cases in which CO<sub>2</sub> is captured from a flue gas stream for utilisation, the CO<sub>2</sub> exits one system in the technosphere and is then taken up by another system within the technosphere. In these coupled systems, von der Assen's preference is for system expansion, in which the system that generates the CO<sub>2</sub> and the system that utilises the CO<sub>2</sub> are evaluated jointly. If systems are being compared, it is important to ensure that they all have the same functions (in this case: production of electricity and polymers).

As many LCAs require the separate assessment of individual products (e.g. only electricity or only polymer), system expansion is not always expedient. In such case, von der Assen considers allocation to be the approach of choice. Von der Assen is highly critical of awarding credits for avoided burdens and believes that there are good reasons to reject this approach.

System expansion as preferred approach

Allocating GHG emissions to the individual products

CO<sub>2</sub> – waste gas or by-product?

According to von der Assen, for GHG emissions to be allocated correctly it is necessary to determine whether the CO<sub>2</sub> is a product with an associated economic value or waste with no economic value. How the system boundaries are defined plays an important role in this regard. GHG emissions from a power plant obviously do not have any economic value. If, however, the power plant is equipped with a carbon capture mechanism, highly concentrated CO<sub>2</sub> is produced as a co-product that is of economic value, at least in today's market. Von der Assen therefore prefers to use economic allocation or, in certain scenarios, the product's exergy. If CO<sub>2</sub> utilisation were to have a negative market value at some future time, it should be treated as a recycling process with the following two functions: disposal of CO<sub>2</sub> and the production of a new (recycling) product.

Assessment of temporary storage

Von der Assen also addresses how LCA of CCU should deal with the temporary storage of CO<sub>2</sub> in products, whereby the period of storage can vary across a very wide range. Current LCA practice does not provide a means of taking delayed CO<sub>2</sub> emissions into account. Von der Assen refers here to the variety of approaches published in the literature for calculating time-dependent characterisation factors. However, von der Assen also notes that the overall effects of the temporary incorporation of CO<sub>2</sub> in products are usually of only minor relevance. In his LCA study of polyols, von der Assen does not include delayed emissions of CO<sub>2</sub> in the assessment.

#### 4.3.3.5 Summary of the methodological proposals presented in the scientific publications

In the scientific publications discussed above there is consensus regarding a number of the issues covered, though there are other aspects for which the approaches taken differ significantly. It is also important to note that none of the publications discussed above individually covers every relevant aspect of the LCA of CCU and that no claim is made here that a comprehensive overview of all relevant publications has been given.

Difference between biogenic and fossil sources

The accounting methodologies for CO<sub>2</sub> removals and biogenic sources of CO<sub>2</sub> proposed by PAS 2050, the ILCD Handbook and by von der Assen are all essentially similar. Emissions are to be treated as negative emissions, irrespective of whether they are achieved through technical or biological processes. This corresponds to the approach set out in ISO/TS 14067.

Temporary CO<sub>2</sub> storage

PAS 2050, the ILCD Handbook and von der Assen all suggest methods for including the temporary storage of CO<sub>2</sub> in the LCA. The first two documents do not define a standardised approach, but describe a methodology that may be applied if required.

The use of a national grid-average electricity mix or a tariff-specific mix (green electricity) is only referred to explicitly in PAS 2050 and in the JRC position paper. Whereas the latter continues to stipulate the national (or European) electricity mix, the PAS 2050 specification includes the option of accounting for 'green tariff' electricity supplies under certain conditions.

All of the publications discussed above address the issue of co-production. PAS 2050:2011 treats this matter only generally without direct reference to the subject of carbon utilisation. With the exception of the JRC position paper, all of the publications emphasise the importance of determining whether the CO<sub>2</sub> that is utilised was generated as a co-product or as waste. In cases where the CO<sub>2</sub> is a co-product, the specifications in PAS 2050 agree with the recommendations from von der Assen. The JRC position paper takes a very different approach that corresponds more closely with the consequential modelling methodology.

Based on the predominant consensus regarding best-practice methodological rules for carbon accounting and bearing in mind the proposals presented in the scientific literature, we present in what follows practical, step-by-step guidance for carbon accounting in CO<sub>2</sub> utilisation initiatives.

Electricity

Multifunctional processes

## 4.4 Guidance on carbon accounting in CO<sub>2</sub> utilisation programmes

### 4.4.1 Origin of the CO<sub>2</sub>

The source of the carbon dioxide is a crucial element within the overall carbon accounting scheme. The CO<sub>2</sub> source is the starting point when compiling the carbon footprint for a CCU system. The following options are available:

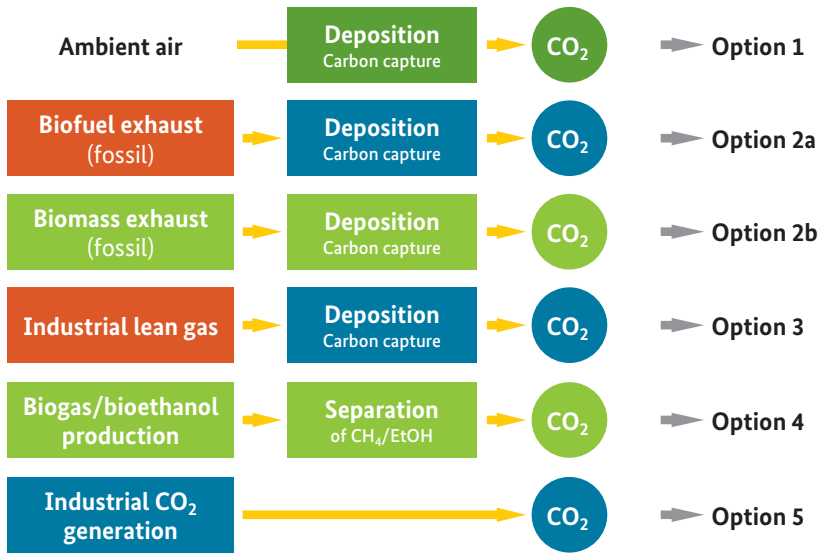

Fig. 114: Different potential sources of CO<sub>2</sub>

#### Option 1: CO<sub>2</sub> is captured directly from ambient air

The CO<sub>2</sub> source is treated like any other feedstock stream for a production process; the burdens are assigned completely to the process that utilises the CO<sub>2</sub>.

As the CO<sub>2</sub> in the atmosphere is part of the carbon cycle of the biosphere, it is treated as a biogenic carbon source, i.e. its capture from the atmosphere is regarded as carbon removal within the terms of ISO/TS 14067.

If the process that is utilising CO<sub>2</sub> is being fed from a non-biogenic point source (Options 2 to 5), it is recommended that Option 1 is adopted as the reference for sensitivity analyses, as the availability of CO<sub>2</sub> from a particular CO<sub>2</sub> source may not be constant, irrespective of how the CO<sub>2</sub> is subsequently processed.

Proposal: Option 1 as reference



**Option 2: CO<sub>2</sub> captured from flue gas**

Potential flue gas streams include those in power plants, cement production plants, waste incinerators or biomass-fuelled power generating facilities.

Whatever the technology, the burdens have to be allocated and the boundary with the combustion process defined. According to the JRC (2016), the supply of CO<sub>2</sub> is in this case ‘rigid’ as the quantity of flue gas will not be affected by the fact that CO<sub>2</sub> is captured from it and subsequently utilised. The CO<sub>2</sub> is therefore regarded as waste and, as such, the up-stream ‘zero burden assumption’ applies.

Where exactly the technical boundary between waste gas and usable CO<sub>2</sub> needs to be drawn can be determined using the price of the gas, as explained in the ILCD Handbook (JRC 2010). It can generally be assumed that untreated exhaust or flue gases always have a negative market value. That is why all of the environmental burdens associated with treating the flue gas in order to generate CO<sub>2</sub> that can be used as feedstock must be allocated to the carbon utilisation system.

Fig. 115:  
Option 2: CO<sub>2</sub> captured from flue gas

Example:

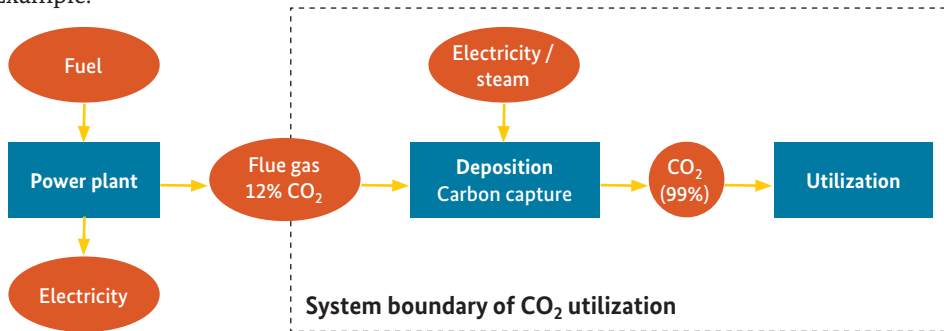

A crucial question is how to include in the carbon accounting scheme the fact that the power plant is no longer emitting CO<sub>2</sub> to the environment. As described in Section 4.3.1.1, the relevant statutory provisions prescribe that the product from the CO<sub>2</sub> utilisation stage must generate zero emissions at end of life. As a result, the CO<sub>2</sub> emissions avoided at the power plant are allocated to the power plant. If this were not done, a real CO<sub>2</sub> emission would have been effectively eliminated from the life cycle inventory.

This rule can be challenged by arguing that the upstream process (the power plant that captures the CO<sub>2</sub>) and the carbon utilisation stage are in fact closely coupled. Both should therefore benefit from the overall reduction in the amount of CO<sub>2</sub> released, i.e. the CO<sub>2</sub> burden should be allocated between the upstream process and the utilisation stage. But as the usual allocation rules (physical properties, market price) are difficult to apply in this case, assigning 50% to

each process seems a reasonable recommendation. This approach has already proved its worth in LCAs of recycling systems (UBA 2002, Detzel et al. 2016).

Whatever the application, the approach selected must be transparent. If the 'politically' motivated approach of 'zero-emissions' at the end of life of a CCU product is adopted, it must be made clear that the carbon emissions are allocated to the upstream process. Failure to do so would contravene the core rule that double counting (in this case, double counting of an emissions reduction) must be strictly avoided. If a 50:50 allocation between the upstream process and the utilisation stage is chosen this too must be justified.

#### **Option 2a: CO<sub>2</sub> generated from a fossil fuel source**

In this case, it is particularly important that, if the CCU product is to be assigned 'zero burden' status at end of life, the fossil carbon emissions must be retained in the carbon accounting of the overall system, i.e. they are allocated to the upstream process (here: the fossil fuel power plant).

This option is also relevant for CO<sub>2</sub> produced from the calcination of limestone or from combusting the fossil portion of solid waste.

#### **Option 2b: CO<sub>2</sub> generated from a biogenic fuel**

In this case, the approach is essentially the same as that for Option 1, i.e. the CO<sub>2</sub> that is captured and utilised is separately defined as of biological origin. If the CO<sub>2</sub> is released at the end of the product's life, the net carbon balance would be zero. If carbon fixation occurs at the end of life, a carbon sink is assigned to the CO<sub>2</sub> utilisation stage (see Section 4.4.3.2).

This option is also relevant when the CO<sub>2</sub> source is the combustion of the biogenic portion of solid waste.

#### **Option 3: CO<sub>2</sub> generated from industrial LCV gas**

The industrial systems of relevance in this option include blast furnaces, a range of petrochemical refinery processes and chemical processes (e.g. steam reforming in the ammonia synthesis process). Here too the emissions burdens have to be allocated and the boundary with the combustion process defined. The carbon source in this option is regarded as 'rigid' and therefore the rule for rigid supplies of CO<sub>2</sub> proposed by the JRC (2016) is applicable. According to this rule, none of the environmental burdens from upstream processes can be allocated to the carbon utilisation stage. However, there is a key difference to Option 2, as the low calorific value gas (e.g. blast furnace gas) has, as its name suggests, a calorific value and as such it should be regarded as a co-product rather than as waste.

**Sample calculation for Option 2: CO<sub>2</sub> captured from flue gas**

A range of different technologies are available for capturing CO<sub>2</sub> from power plant exhaust gas streams. One of the best known technologies is capture by chemical absorption, which, as an end-of-pipe technology, can therefore be retrofitted to existing power plants. Carbon capture occurs by absorbing the CO<sub>2</sub> from the flue gas stream by means of a solvent. In this example we consider an advanced gas-fired power plant that requires about 45 kg of natural gas to generate 1 GJ of electrical energy. The combustion process generates around 120 kg of CO<sub>2</sub>. Emissions of approximately 0.5 kg CO<sub>2</sub>-eq are associated with the fuel supply chain (gas extraction and transport), but these will be ignored in the current calculation.

The amine scrubbing method of CO<sub>2</sub> capture is carried out in two stages: 1. Absorption of the CO<sub>2</sub> by an aqueous amine solution and 2. Regeneration of the solvent by heating the saturated solvent to release (desorb) the CO<sub>2</sub>. The large volume streams involved, the relatively low concentrations of CO<sub>2</sub> in the flue gas (approx. 12% in the crude gas due to presence of air nitrogen) and the limited absorption capacity of the amine solvent mean that a comparatively large amount of energy is needed to drive the capture process. In this example, solvent regeneration requires 2.5 GJ of steam per metric ton of captured CO<sub>2</sub>. This reduces the overall efficiency of the power plant by eight percentage points and results in greater fuel consumption in the power plant for no change in the amount of electricity generated. We assume here that the carbon capture process has an efficiency of 90%.

<b>Without CO<sub>2</sub> capture</b>	<b>Input</b>		<b>Output</b>	<b>Output</b>	
	Natural gas	45 kg		Electrical energy	1.000 MJ
				CO <sub>2</sub> emission	120 kg
<b>With CO<sub>2</sub> capture</b>	<b>Input</b>		<b>Output</b>	<b>Output</b>	
	Natural gas	52 kg		Electrical energy	1.000 MJ
				CO <sub>2</sub> production	126 kg
				CO <sub>2</sub> emission	14 kg

System expansion is not possible without additional information on how the captured CO<sub>2</sub> will be utilised. The problem of how to allocate the environmental burdens from the production process has to be addressed: the CO<sub>2</sub> is no longer a climatically harmful emission, but a co-product; and what was a single-function process (electricity generation) has now become a multifunctional process (producing electricity and CO<sub>2</sub>). The various approaches to allocation discussed in the main text yield the following results when applied to the present example:

- a) The product from the CO<sub>2</sub> utilisation stage (the ‘CCU product’) is a ‘zero-emission’ product at end of life (iLUC Directive (EU) 2015/1513): The main burden of 126 kg CO<sub>2</sub>, which would be released when the product from the CO<sub>2</sub> utilisation stage undergoes end-of-life combustion, is in this case assigned in full to the electricity generation process, plus the residual emissions of 14 kg CO<sub>2</sub>. As this is greater than the emissions burden from generating 1 GJ of electrical energy without carbon capture, there is clearly no incentive to the power plant operator to capture CO<sub>2</sub>.
- b) 50:50 split between both processes: Each product (electricity and CO<sub>2</sub>) is assigned a burden of 70 kg CO<sub>2</sub>-eq. The emissions burden associated with electricity production is therefore lower (70 kg instead of 120 kg CO<sub>2</sub>-eq./GJ) and the CCU product also generates a smaller environmental burden at its end-of-life combustion than if it had been produced from fossil carbon (70 kg instead of 126 kg CO<sub>2</sub>-eq.).

Other common methods of allocation lead to highly skewed results: At the process level, one could argue that in the case ‘without carbon capture’, the production of 1 GJ of electricity from natural gas generates average GHG emissions of 120 kg CO<sub>2</sub>-eq. If, however, the CO<sub>2</sub> is captured (with an efficiency of 90%), the remaining GHG emissions are only 14 kg CO<sub>2</sub>-eq., which is then allocated between the two products.<sup>8</sup> As electrical energy and CO<sub>2</sub> do not have any common physical properties, environmental burdens can only be allocated on the basis of market value. If we assume prices of € 0.10/kWh and €8/t CO<sub>2</sub>, electricity is assigned 96% of the burden, while 4% is allocated to the CO<sub>2</sub>.

A power plant operator would no doubt be very pleased with such an approach, as the electricity generated is now essentially ‘emissions free’ (13 kg CO<sub>2</sub> instead of 120 kg CO<sub>2</sub> per 1 GJ of electricity). The recipient of the CO<sub>2</sub> (‘the downstream processor’), who utilises the CO<sub>2</sub> and is responsible for the carbon inventory for the remaining life of any products produced, would clearly be less happy with this scenario, as the burden is in this case 1 kg CO<sub>2</sub>-eq. per 126 kg of CCU product. In addition to the cost of processing and converting the CO<sub>2</sub> into a marketable product, the downstream processor must bear the full emissions burden from the end-of-life combustion of the product. This burden will be approximately equal to the 126 kg of CO<sub>2</sub> captured from the fuel combustion process in the power generating plant, but no negative emissions credits would be issued in this case as the CO<sub>2</sub> has not been removed from the atmosphere but generated from a technical process.

<sup>8</sup> As the calculation is normalised to the production of 1 GJ of electricity, reduced efficiency requires the consumption of more natural gas. The total quantity of CO<sub>2</sub> (from the gas combustion process) therefore increases to 140 kg.

There are two approaches that can be adopted to take this into account:

- a. Allocation: The environmental burdens associated with the industrial process and its upstream chains are allocated between the main product (e.g. steel or ammonia) and the LCV gas. This can be challenging, as the process can be complex, but mainly because it tends to be difficult to define the basis for an allocation rule:
  - mass is not a suitable property on which to base allocation in this case
  - energy content is not applicable in the case of steel
  - market price may be applicable if available for LCV gas and if pricing is transparent.
  
- b. Issuing a GHG emissions debit: A GHG emissions debit is issued to the CO<sub>2</sub> utilisation stage for that portion of the LCV gas that would otherwise have been used by the industrial process as a fuel source. This is the approach recommended by the JRC (2016). It assumes that a transparent energy needs analysis has been conducted for the upstream industrial process. After that, the GHG emissions debit has to be specified precisely, e.g. electricity from the general grid-average mix for electricity that could have been generated from the LCV gas.

In the opinion of the present authors, allocation would be the more coherent approach to take, but the JRC methodology of awarding an emissions debit significantly simplifies the carbon accounting.

Fig. 116:  
Option 3: CO<sub>2</sub> generated from industrial LCV gas

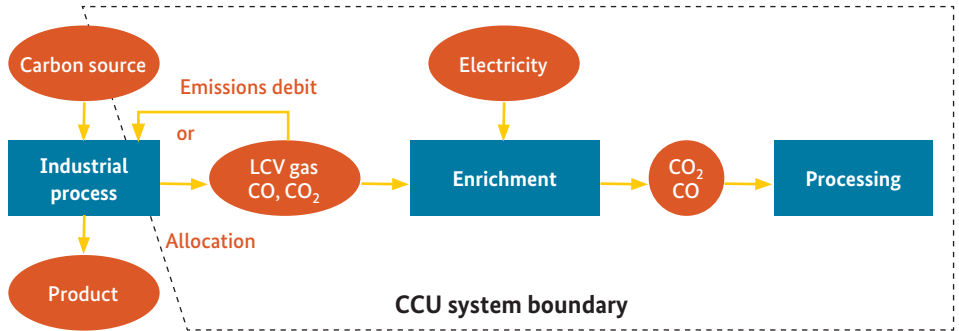

Any post-production processing of the LCV gas (e.g. purification, enrichment) required for the CO<sub>2</sub> utilisation process lies within the system boundary of the carbon utilisation stage.

**Option 4: CO<sub>2</sub> from biogas or bioethanol production facilities**

CO<sub>2</sub> is produced in substantial quantities during the fermentation stage of the biological (and biotechnological) production of biogas or bioethanol. Usually, this CO<sub>2</sub> is released to the environment. Here too none of the en-

environmental burdens from the CO<sub>2</sub> production process may be allocated to the carbon utilisation stage. However, if additional energy is required to capture the CO<sub>2</sub> from the fermentation facility, the associated burdens would be included within the CCU system boundary.

As the CO<sub>2</sub> is biogenic, the approach adopted is the same as in Option 2b, i.e. the CO<sub>2</sub> that is captured and utilised is separately defined as of biological origin. No credits may be issued for the products methane or ethanol<sup>9</sup>, because – as explained for Option 2 and Option 3 – the bonus is assigned fully to the CCU product in order to avoid double-counting of avoided GHG emissions. The requirement regarding CCR issued by the EU Commission (2010) and described in Section 4.3.1.1 must also be observed. This states that for a bonus to be admissible, it must be demonstrated that utilisation of the captured CO<sub>2</sub> does in fact replace CO<sub>2</sub> that would otherwise have to be derived from fossil sources. In the case being discussed here, i.e. the utilisation of CO<sub>2</sub> to produce a PtX fuel, the GHG emissions savings included in the carbon inventory are limited to the savings in GHG emissions that would otherwise have been generated from a fossil fuel source. If the captured CO<sub>2</sub> were used to synthesise a chemical product, the GHG emissions savings would be determined by comparison with the (petroleum-based) product being replaced.

Fig. 117:  
Option 4: CO<sub>2</sub> from biogas or bioethanol production facilities

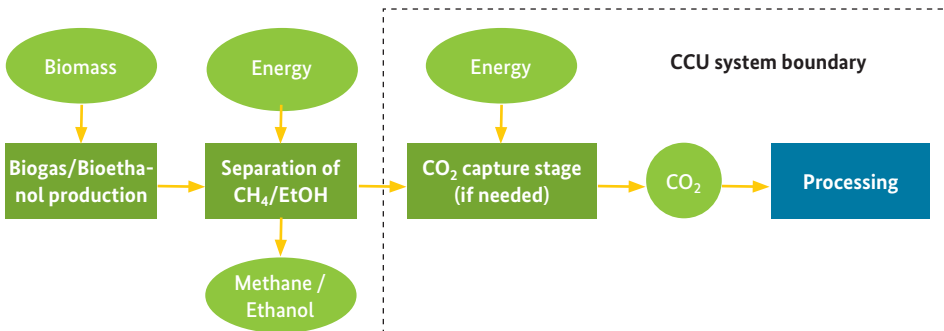

**Option 5: The CO<sub>2</sub> is industrially produced for a specific purpose**

In this case, the upstream process that generates the CO<sub>2</sub> (including the carbon source) is included within the CO<sub>2</sub> utilisation stage. Boundaries to other systems do not therefore need to be drawn in this case.

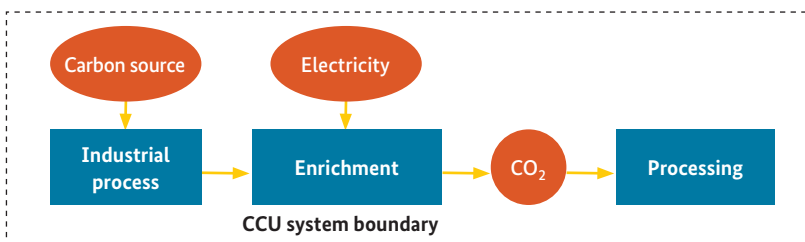

Fig. 118:  
Option 5: CO<sub>2</sub> is industrially produced for a specific purpose

9 e.g. calculation of GHG intensity as per RED Annex V, Part C, No. 15 for the term eCCR (carbon capture and replacement)

**Other options and variants**

The five options discussed above effectively cover the main types of CO<sub>2</sub> sources found in CCU scenarios. There are, however, a very wide variety of technological configurations associated with each of these main CO<sub>2</sub> sources, so that not all conceivable variations can be presented here.

**Coupled systems**

There are, for example, numerous ways in which the upstream process and the CO<sub>2</sub> utilisation stage can be closely coupled together. A variant of Option 2a is presented here as an example: When the hydrogen needed in the synthesis process is produced, oxygen is also generated as a by-product. This oxygen can be used in the upstream industrial process that generates the CO<sub>2</sub> (power plant, cement works), for example, via the oxyfuel process, which minimises the flue gas volume and reduces the energetic cost of separating the CO<sub>2</sub> from the exhaust gas stream. This example will be discussed again in Section 4.4.2.2.

Fig. 119: Option 2 with coupling between the upstream CO<sub>2</sub> generating process and the CO<sub>2</sub> utilisation stage

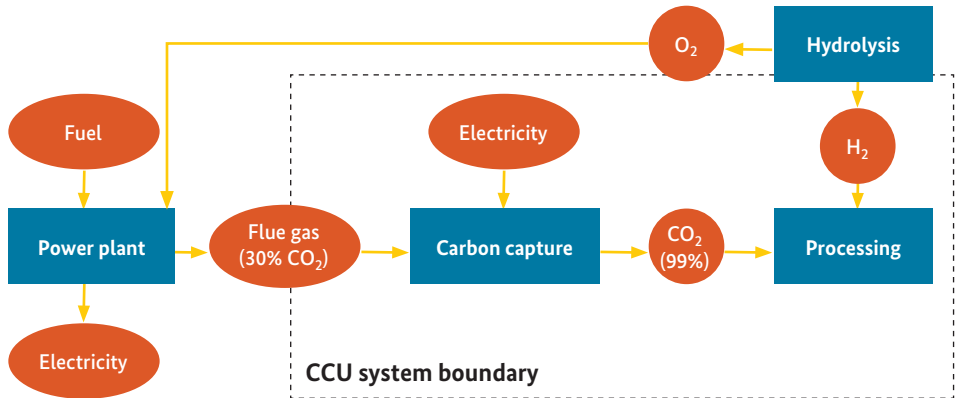

**4.4.2 Processing**

The process chain involved in synthesising chemical products from CO<sub>2</sub> also raises a number of questions that can have a potentially crucial influence on the carbon inventory. The main issues can be represented in the following simplified schematic.

The questions can be grouped into the following categories:

- Defining the boundary line to upstream processes (interface to 4.1)
- Dealing with multifunctional systems
- Identifying the conditions for including RES electricity in the carbon accounting scheme.

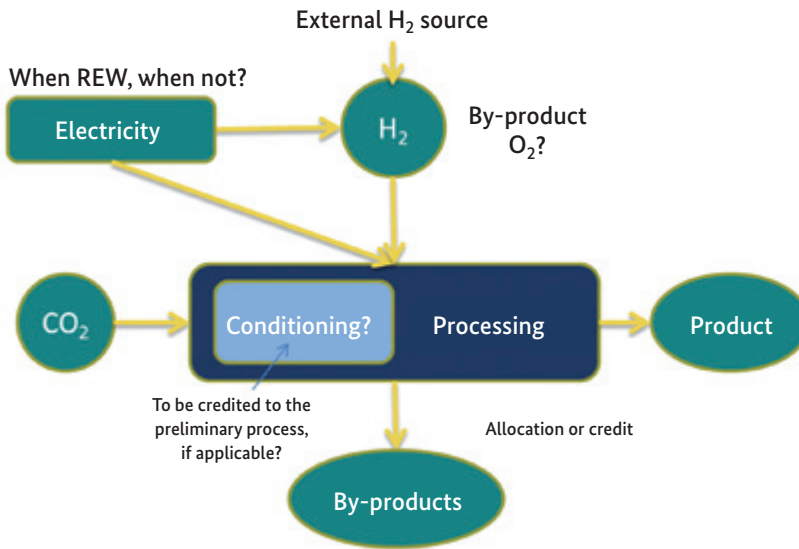

Fig. 120: Highly simplified scheme for processing CO<sub>2</sub> into chemical products

#### 4.4.2.1 Defining the boundary to upstream processes

The options for dealing with the various upstream processes that generate CO<sub>2</sub> were dealt with in Section 4.1. We reiterate here the importance of defining the boundary in a coherent manner. Any processing steps that need to be carried out before the CO<sub>2</sub> can be utilised are always assigned to the CCU system.

In the case of coupled systems, the decision where to draw the boundary line requires detailed justification. The primary and crucial question is how the burdens and benefits are partitioned between the systems. It is essentially a politically motivated convention that ascribes ‘CO<sub>2</sub> neutrality’ to the product of a CO<sub>2</sub> utilisation stage, e.g. a PtX transport fuel or ‘electrofuel’.

#### 4.4.2.2 Dealing with multifunctional systems

In practical industrial production processes, it is the rule rather than the exception that co-products are generated. As was demonstrated in detail in Section 3, the question of how co-products should be incorporated into the LCA framework remains a central issue that has not been unambiguously resolved by experts studying and working in the field. While the ISO standards on life cycle assessments and carbon footprints of products express a preference for system expansion over allocation, practical reality demonstrates that system expansion is often complex and allocation is frequently unavoidable.

Irrespective of the computational methodology employed, the first question that arises is whether an output flow should be categorised as a co-product

Co-product or waste

or as waste. As with the issue of allocation/substitution, no consensus has been reached on how this question is best answered. In this report, we have discussed the question in terms of the waste properties of the CO<sub>2</sub>. The proposal introduced in the ILCD Handbook (JRC 2010), which focuses on market value, is regarded as the most substantive, as, ultimately, it is economic value that is used to distinguish between the two categories.

Despite all of the understandable reservations concerning the use of economic quantities in technical and scientific calculations, we recommend the use of a positive market price as the most suitable indicator for delineating the boundary between the two fundamental categories ‘co-product’ and ‘waste’.

Allocation or credit

The debate on allocation vs. system expansion has been ongoing for decades and we make no claim to have resolved it in this report. The sheer quantity of material that has been written on this matter is legion. The discussion presented here is a very simplified one and recognises that in many practical applications, system expansion is equated with the emissions credit method. A ‘real’ system expansion would mean that the carbon inventory would no longer refer to the final product of interest, but rather to a system with expanded functionality. The substitution approach is based on the assumption that the target product is the driver of the whole process. That means that all burdens remain associated with the target product. The impact from substitution is assigned wholly to the target product by subtracting the carbon footprint associated with the substituted production processes.

Fig. 121: Simplified schematic comparing allocation (left) and substitution (right)

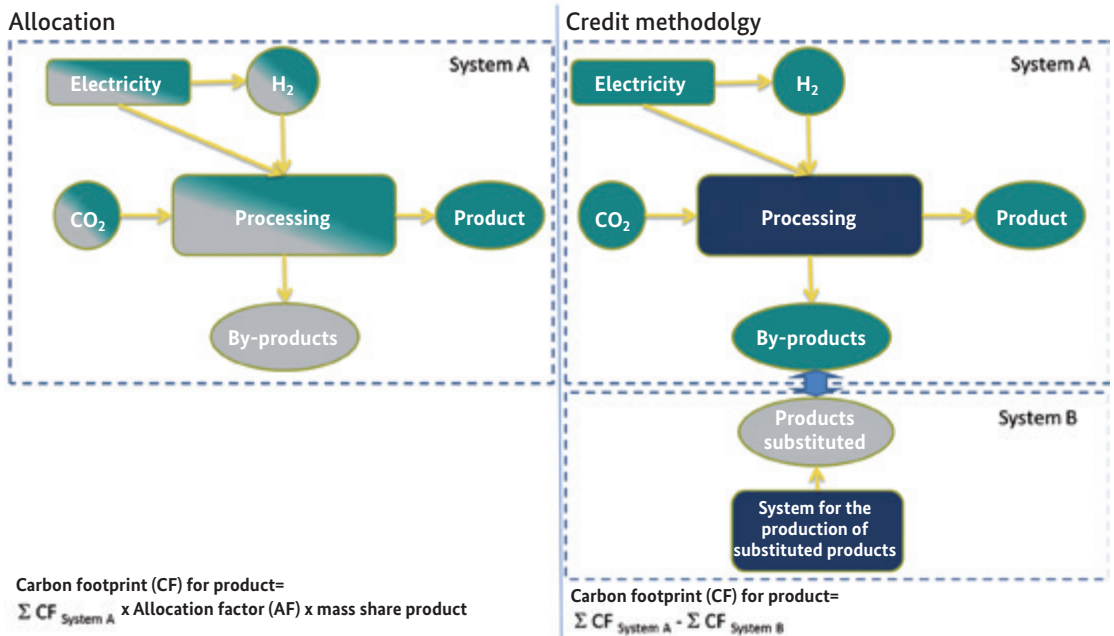



When deciding on which approach to adopt, the following points must be taken into account:

- The choice of approach must be retained throughout the entire LCA. It is not acceptable for the allocation method to be adopted for one co-product, while an emissions credit approach is selected for another co-product elsewhere in the system.<sup>10</sup>
- Depending on the goal of the LCA study, external specifications may have to be followed. For example, in Annex V to the RED, the methodology for calculating the GHG impact of biofuels specifies allocation as the method of choice. LCAs that are associated in some way with the RED or the FQD (e.g. GHG emissions reductions through the use of PtX products) will therefore have to make consistent use of the allocation method.
- If the allocation method is selected, reasons must be given for this choice, which must be relatable to co-product functionality (e.g. calorific value).
- The substitution method requires detailed reasons to be given as to which processes are to be substituted. What is to be substituted within the ‘consequential LCA model’? The answer to this question requires, at a minimum, a comprehensive analysis of what would happen if the co-product were to be introduced in to the market. For example, in the case of excess electricity, one question to be addressed would be: ‘Which power plants would be shut down if the excess electricity is fed into the grid?’
- It should be noted that the effect of credits on the carbon inventory can be far more significant than allocation (Fehrenbach et al. 2016). The magnitude of potential fluctuation margins in the results is considerably larger than in the case of allocation, where fluctuations always remain within the actual system boundary. In certain cases, emission credits can therefore lead to negative overall carbon inventories.
- The emissions credit methodology can lead to conflicts that are hard to resolve, such as when co-products are to be included in the inventory in the same way as CCU products. A co-product may not be included as a credit in the GHG emissions inventory of another co-product, as the overall carbon inventory would no longer be consistent.

<sup>10</sup> It is, however, important to note that in the most commonly used datasets (e.g. Ecoinvent, Gabi, Probas etc.) allocations or credits are already included for upstream products or precursors (e.g. chemicals or grid electricity). Achieving complete consistency within an LCA is illusory.

Carbon accounting in multifunctional (coupled) systems

By their very nature coupled (i.e. multifunctional) systems are more complex, so it is essential to state precisely:

- how the systems are coupled
- what the alternatives to the coupled system are and/or what special benefits accrue from coupling
- where systems boundaries need to be drawn and what consequences this has for the carbon accounting scheme.

This approach will be illustrated below using the example introduced at the end of section 4.4.1, which concerned the use of oxygen in CO<sub>2</sub>-supplying combustion processes. The coupling (or multifunctionality) relates to the O<sub>2</sub> formed in the (hydrogen-generating) hydrolysis reaction and its capture and use in the upstream combustion process that produces utilisable CO<sub>2</sub>. For coupling to be effective, the combustion process needs to be technically configured to make use of the oxygen (in what is known as the oxy-fuel process), which leads to reduced flue gas volumes, which, in turn, substantially reduces the energy needed to capture the CO<sub>2</sub>. Both subsystems are therefore actively coupled and each needs additional technical input.

The benefits of coupling are all acquired by the CCU system, as it receives the CO<sub>2</sub> feed-stock for a lower energetic cost. The additional energetic cost is actually borne by the combustion process, though efficiency improvements

Fig. 122: Example of an emissions accounting scheme for a coupled (multifunctional) system

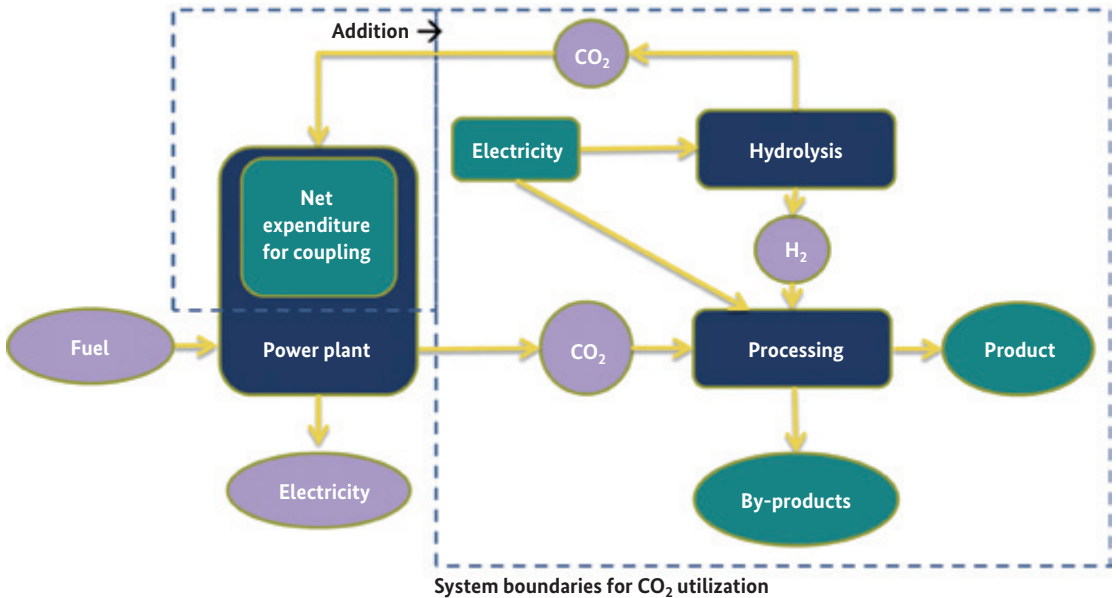

may also result elsewhere within the power plant, as lower flue gas volumes may reduce the cost and effort associated with flue gas treatment. The net burden borne by the CO<sub>2</sub> supplying system as a result of coupling must therefore be assigned to the system that utilises the CO<sub>2</sub>. Carbon accounting methods therefore need to be applied to the adapted upstream process. This requires calculating the energetic cost incurred minus any beneficial effects arising from the coupling of the systems. The net burden would then be assigned to the CCU system.

**4.4.2.3 Systems in which the CO<sub>2</sub> is recycled**

From a technical perspective, there are a number of different recycling concepts that could be applied to the CCU system. Here, the focus is placed on carbon recycling. One obvious concept would be to recycle the CO<sub>2</sub> after use, returning it as input to the carbon utilisation process. This would replace an external carbon or CO<sub>2</sub> source and would avoid any final carbon emissions or the need for carbon sequestration. This concept of carbon recycling could be implemented as a large loop that includes the product use phase, or as a smaller-scale recycling loop within the production process. In the latter case, it would be necessary to define what the function of this pathway is, as the carbon product never leaves the production cycle.

No matter how the carbon recycling loop is defined, it is crucial that the system boundaries are preserved. As recycling loops are never loss-free, particular care needs to be taken to ensure that inputs are correctly assigned at the beginning of the loop and that losses are compensated for.

The temporary storage of carbon by keeping CO<sub>2</sub> within the recycling loop can be considered irrelevant if the recycling loop is internal to the produc-

Fig. 123:  
Example of a CO<sub>2</sub> recycling loop

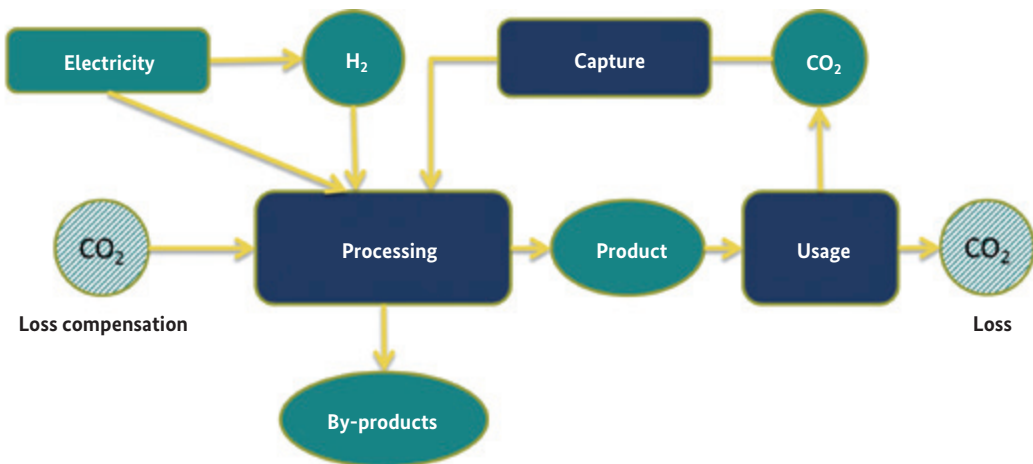

tion process, i.e. the CO<sub>2</sub> or carbon acts only as a carrier medium.<sup>11</sup> If the recycling loop is more extensive, the question of product lifetimes arises (see also Section 4.3.2), which, if these are of short duration, can make it difficult to maintain a recycling loop.

**4.4.2.4 When can RES electricity be included in the carbon emissions inventory?**

This question is of fundamental importance to the entire concept of carbon utilisation. The assumed availability of excess RES electricity provides the underlying justification for promoting the albeit rather inefficient storage of energy in chemicals synthesised from CO<sub>2</sub>. Were one to use electricity drawn from the average grid mix or from fossil fuel power plants, the GHG emissions would be very high. In the most extreme cases (e.g. using coal as the primary energy source), the associated GHG intensity can be several times greater than that achieved using a conventional fossil fuel (see example from Commission Directive (EU) 2015/652 discussed in Section 4.3.1.1 above).

In practice, however, incorporating RES electricity proves complex. As far as the current state of development in Germany is concerned, the supply of electricity from renewable sources is affected by a number of technical, economic and societal factors. If PtX products are to be produced and used in greater quantities in future, an overall strategy will be required under which the requisite amounts of RES electricity can be allocated (Zech et al. 2016). At present, the quantities of excess RES electricity available are simply insufficient. In view of this, initial emphasis in Germany should be placed on getting verified proof that CCU processes are being powered by RES electricity that has been certified as such in accordance with the German Renewa-

Fig. 124: Requirements for incorporating RES electricity into an emissions accounting mechanism

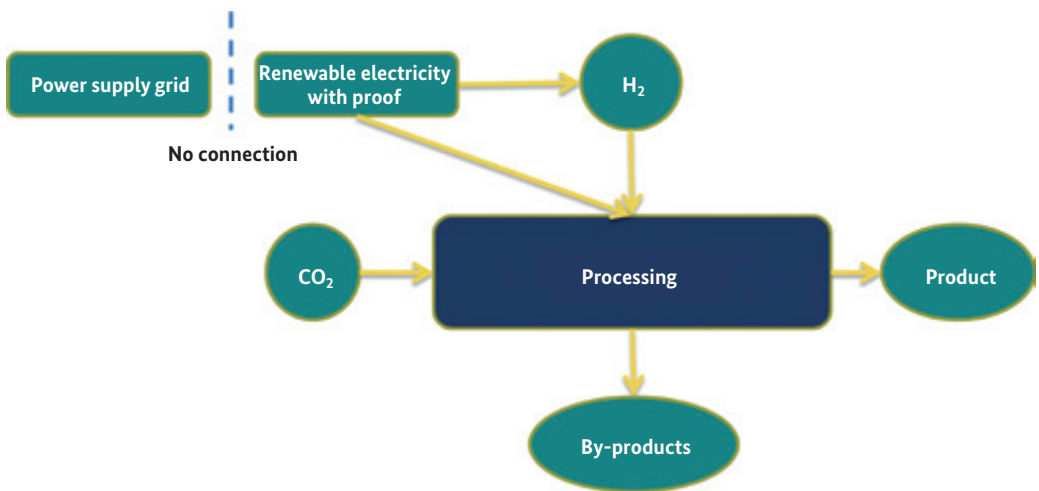

<sup>11</sup> In this case, the actual product is not the CO<sub>2</sub> within the recycling loop, but some other substance (depicted in the diagram as 'co-product').

ble Energy Act. This is stipulated in the draft of the 37th Ordinance on the Implementation of the Federal Immission Control Act concerning PtX fuels (BMUB 2016a), which states that if the (very low) default value for the GHG intensity<sup>12</sup> is claimed, the electricity may only come from verifiable non-biological sources of renewable energy.

On the basis of what has just been presented, two further conditions become apparent:

- Renewable electricity certificates or emissions trading certificates cannot be used. This has received broad support from a number of standards, such as the rules set out in the GHG Protocol.
- Over the longer term, both additionality and the issue of excess RES electricity will need to be included in the verification process in order to facilitate the incorporation of RES electricity into carbon accounting systems. If CCU concepts are widely implemented in future, simply providing proof that RES electricity is being used will not suffice if that same RES electricity could otherwise have been used in the general grid supply.

#### 4.4.2.5 Dealing with other inputs

The hydrolysis of water is not the only potential source of hydrogen. Numerous process gases in the chemical industry exhibit potentially exploitable concentrations of hydrogen. If these gases are used for the synthesis of CO<sub>2</sub>-based chemicals, the generally accepted rules of good accounting practice will still apply exactly as they do, for example, to alternative sources of CO<sub>2</sub> (see Section 4.4.1, Option 3, industrial LCV as source of CO<sub>2</sub>).

#### 4.4.2.6 Creating a consistent and coherent emissions accounting scheme

In light of the complexity of the CCU processes, we strongly recommend producing a full carbon inventory when calculating a carbon footprint. This allows inconsistencies between the input and output flows to be identified and corrected as required. Particular attention should be given to losses within the process chain. Losses not only contribute to the carbon inventory in the form of CO<sub>2</sub> emissions (if of fossil origin), but also on the input side in the case of carbon removals (CO<sub>2</sub> from biological sources or captured from ambient air).

<sup>12</sup> In the EU Directive (EU) 2015/652 (Annex 1, Part 2) and in the German draft ordinance on PtX (Annex 1), a default value of 3.3 g CO<sub>2</sub>-eq/MJ is given for compressed synthetic methane manufactured via the Sabatier reaction using hydrogen from non-biological renewable energy electrolysis.

### 4.4.3 Utilisation

The use phase of a CCU product represents the third large complex of questions that need to be examined when establishing a carbon footprint accounting methodology. This phase includes both the service life and the end-of-life stage of the CCU product, which in the case of a fuel are one and the same thing.

When an individual product (e.g. a car’s centre console manufactured from a special plastic) is being assessed, the complexity of the assessment reflects the complexity of the product’s function. However, when alternative products are compared, the use phase is frequently ignored. Exceptions can arise if, using the example of the automobile console mentioned above, the life cycle of the vehicle is explicitly included in the LCA goal, and a more light-weight console would affect the calculation of fuel consumption.

Similar arguments apply at the end of the product’s life, where the typical end-of-life options (reconditioning/reuse, material recycling, combustion) are assumed to lead to the same carbon inventory result irrespective of whether the plastic used comes from a conventional production source or from a CCU process.

It is therefore common practice to position the system boundary at that point at which a functionally identical reference product exists to enable meaningful comparisons to be made. This is illustrated in Figure 15, which is from the tutorial review presented by von der Assen (2013a). The ‘gate-to-grave’ phase is identical for methanol from ‘traditional’ (i.e. fossil-based) production and for CCU-based methanol. The system boundary can therefore be limited to the processes in the ‘cradle-to-gate’ phase.

Fig. 125: Limiting the system boundary to the cradle-to-gate phase, when the use phases and end-of-life phases of the systems being compared are identical (from von der Assen et al. (2013a))

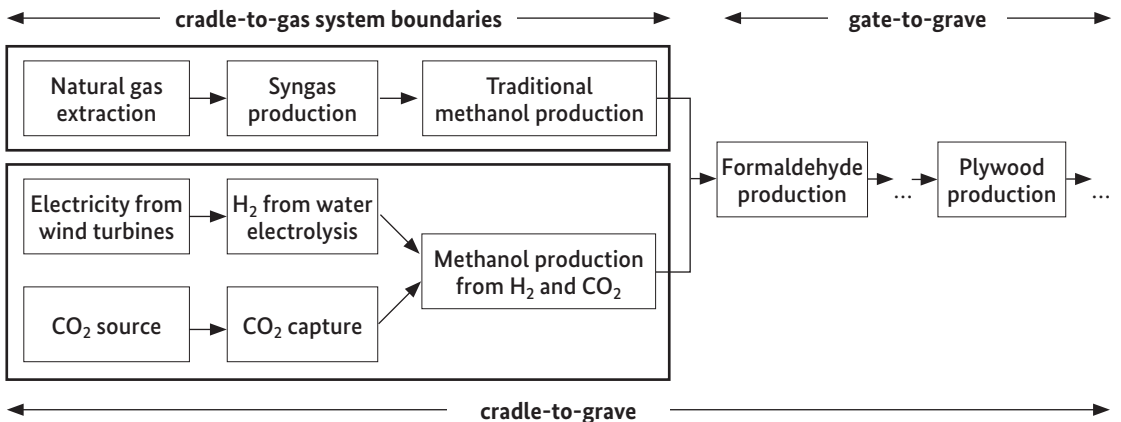

It is important to remember in a pure cradle-to-gate analysis that bound CO<sub>2</sub> is actually released (emitted) at the end of the product’s life cycle – unless carbon sequestration occurs. The following two aspects must therefore be taken into account:

- If the CO<sub>2</sub> is sequestered, we return to the distinction between biogenic CO<sub>2</sub> and fossil-based or mineral-based CO<sub>2</sub>, which was made earlier when discussing accounting methods for the source of the raw material (in this case: CO<sub>2</sub>).
- The question of temporary storage of CO<sub>2</sub> in products. Utilising CO<sub>2</sub> removes this greenhouse gas from the atmosphere and therefore renders it climatically inactive for a certain period.

This issue is highly controversial among experts in the field and so far, no consensus has been achieved as to how this should be included in GHG inventories.

The authors’ proposals on how best to deal with these two overlapping aspects are presented in the following sections.

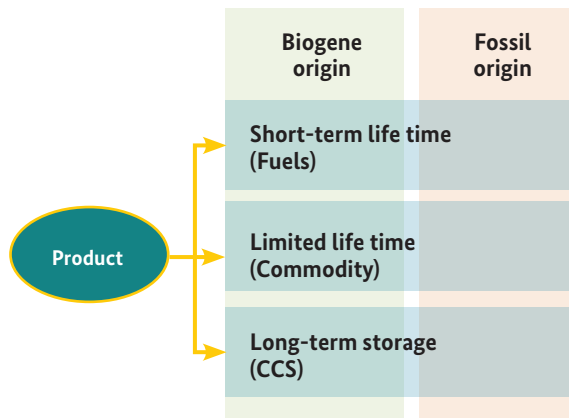

Fig. 126: Options matrix for use and storage of CCU products

**4.4.3.1 Distinction between biogenic and fossil/mineral CO<sub>2</sub>**

In Section 4.1, two biological sources of CO<sub>2</sub> are described in Options 1, 2b and 4. For the carbon inventory, removal of CO<sub>2</sub> from the atmosphere due to the growth of biomass is treated as a ‘negative emission’ for accounting purposes.

This negative emission is countered at the end of the life cycle when the CCU product is used (burned as a fuel) or disposed of (after use as a material) resulting in a zero net contribution to the CO<sub>2</sub> inventory.

Biogenic CO<sub>2</sub>

If the CO<sub>2</sub> undergoes end-of-life sequestration (CCS for combustion sources or permanent storage of the product), no such balancing of negative and positive emissions occurs and the negative emission is retained in the carbon inventory. It is therefore possible to end up with an overall negative carbon emissions value (net carbon sink).

Fossil or mineral sources

The other sources of CO<sub>2</sub> discussed in Section 4.4.1 are fossil sources and mineral sources (e.g. from cement production facilities). The distinction was made between those sources in which the CO<sub>2</sub> was available for utilisation as a waste substance with no net burden (Options 2a and 3) and those sources that specially produced CO<sub>2</sub> for utilisation (Option 5). In the first case, the net balance between carbon removal and carbon emissions is zero, as the emissions burden is completely assigned to the upstream (CO<sub>2</sub>-generating) process, unless an allocation approach has been adopted and the burden has been reasonably partitioned between the upstream CO<sub>2</sub>-generating process and the CO<sub>2</sub>-utilising process.

In the second case, the CCU product retains fossil-character right through to end of life, resulting in a carbon footprint that is likely to be far larger than that of the original fossil-based raw materials.

#### 4.4.3.2 Temporary storage of CO<sub>2</sub>

The utilisation of CO<sub>2</sub> automatically results in the temporary storage of the gas that would otherwise be released to the atmosphere and contribute to climate change. In the case of direct air capture, temporary storage spans the period from capture up until the end of life of the CCU product (exception: recycling loops). If CO<sub>2</sub> from an industrial combustion flue stream is captured and utilised, no CO<sub>2</sub> is removed from the atmosphere, instead CO<sub>2</sub> that would otherwise have been emitted into the atmosphere is bound in a product. This results in delayed emission of CO<sub>2</sub> at the end of the product's life.

Taking delayed emissions into account

Current LCA or GHG accounting methodologies make no attempt to include the time at which emissions or removals occur. At present the default characterisation factor used is the global warming potential (GWP), which enables the impact of GHG emissions to be taken into account over a fixed time horizon. Typically, a time horizon of 100 years is selected. The decision to use a time horizon of 100 years was more political than scientific (Brandão 2012). The time horizon behind the GWP100 characterisation factor can lead to problems of consistency when considering emissions that are initiated at different times. Choosing to use GWP100 means that the impact of greenhouse gas emissions associated with, say, the manufacture of a product in 2017 will be taken into account up until the year 2117. The impact of greenhouse gas emissions from the end-of-life treatment of a product that has been used for 10 years will be taken into account up until 2127. In this sce-



nario, an LCA or GHG inventory would consider the environmental impact of the emissions not for the politically mandated time horizon of 100 years, but also, in part, for 110 years.

Within the CCU context, this means that the removal of CO<sub>2</sub> and its later release cancel each other out as a result of time-independent characterisation factors. The temporary storage of the CO<sub>2</sub> has no effect on the final carbon inventory. A delayed emission does not have a positive effect, as the same 100-year time horizon is always assumed. A number of researchers have therefore developed methods that allow delayed emissions of CO<sub>2</sub> to be taken into account. Thus far, however, it has not proved possible to find a consensus regarding the methodology to be used. This is in part due to the continuing debate as to whether the temporary storage of CO<sub>2</sub> has any positive impact whatsoever, as discussed by Brandão et al. in several publications (Brandão et al. 2012).

Taking delayed emission into account is not restricted to CCU scenarios and is of relevance within a broader context. Essentially, the problem arises with all bio-based products, but also with attempts to compute carbon footprints for reforestation projects, as the carbon sequestration does not occur in a single year but over a much longer period of time.

Using delayed CO<sub>2</sub> emissions as the basis for assessing the effects of temporary carbon storage means that the time when CO<sub>2</sub> is actually released from all of the upstream and downstream processes must be known if consistent carbon emissions accounting is to be performed. In many cases, however, this requirement cannot be met.

For CCU products, storage duration is primarily determined by product lifetime. For the majority of CCU product groups, product lifetimes tend to be rather short.

Products with short lifetimes include transport fuels or the CO<sub>2</sub> used for carbonated products in the beverage industry. The lifetimes of consumables, such as plastic products, are in most cases limited to less than ten years.

The storage of CO<sub>2</sub> in CCU products differs from that in carbon capture and sequestration/storage because of the significantly longer storage periods involved in CCS schemes. Even CCS schemes cannot guarantee permanent loss-free storage, but sequestration times are typically measured in thousands of years, whereas temporary carbon storage in CCU products is mostly a matter of years or, in some cases, a few decades.

Difference between  
CCU and CCS

Recommended action

In view of the fact that temporary CO<sub>2</sub> storage in CCU products remains a highly contentious issue, and given (I) the lack of a consensus on methodology, (II) the typically short storage periods involved, (III) the common lack of any temporal GHG emission profiles and (IV) the fact that numerous standards (see Section 3, particularly the GHG Protocol and the ILCD Handbook) discuss the issue but choose to retain the conventional approach, we recommend the continued use of the established GWP100 characterisation factor in carbon accounting schemes for CCU systems. Temporary storage of CO<sub>2</sub> should, though, be examined separately in those cases in which a comparatively long storage period is expected (e.g. more than 50 years).

Fig. 127: Possible approaches to dealing with temporary storage of CO<sub>2</sub>

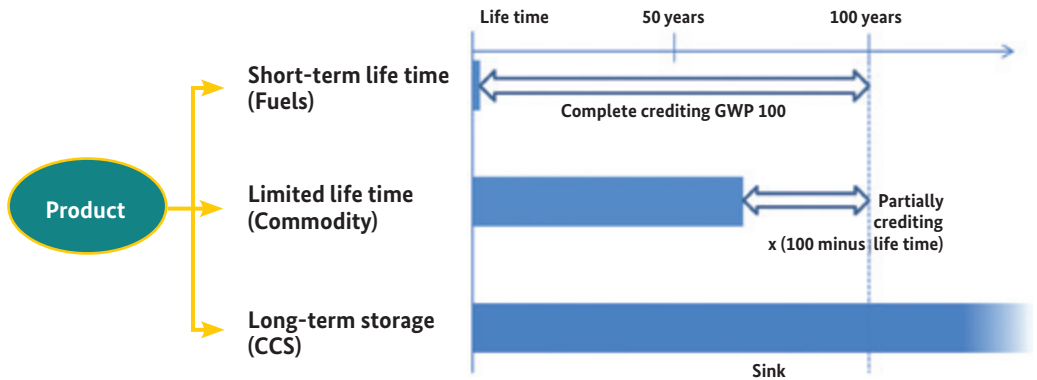

4.4.3.3 When does a carbon sink occur?

In the previous section we discussed the issue of permanent carbon storage (CCS). But how does CCS actually effect the carbon footprint? Including a carbon sink in the CO<sub>2</sub> accounting scheme must always be considered in conjunction with the CO<sub>2</sub> source. The key element is to ensure that the carbon accounting is internally consistent; real emissions must never be defined in such a way that they are no longer within the system boundary and emission reductions must never be counted twice. With respect to the options presented in Section 4.4.1, carbon sequestration can be treated using the approaches set out below.

We start by sketching out the approach adopted when dealing with Options 1, 2a, 3 and 5:

**Option 1:** CO<sub>2</sub> is captured from the ambient air, which generates a negative emission at the beginning of the accounting chain that is retained at the end and is assigned to the CCU process.

In **Options 2a and 3**, the fossil-based CO<sub>2</sub> is received 'burden-free' from the upstream process and the final fossil CO<sub>2</sub> emission remains within the

CCS of fossil-based CO<sub>2</sub> = 'zero net emissions' – not a real carbon sink

boundary of the upstream supply system. As the sequestration of fossil CO<sub>2</sub> represents a ‘net zero emission’, the ‘net bonus’ arising from the CO<sub>2</sub> utilisation phase ‘balances out’ the ‘net burden’ from the upstream CO<sub>2</sub> source.

In **Option 5**, the fossil-based CO<sub>2</sub> is generated specifically for the utilisation phase. Without sequestration, end-of-life emissions are assigned to the CCU product as they would be to any fossil-based product. Sequestration (i.e. ‘permanent’ CO<sub>2</sub> storage) enables the CCU system to attain, at best, ‘zero net emissions’ or ‘carbon neutral’ status.

The situation is more complex for those options that involve biogenic CO<sub>2</sub> (Options 2b and 4). In these cases, the CO<sub>2</sub> is supplied by an upstream process (e.g. bioethanol production) and the carbon capture process lies within the system boundary of the upstream bioethanol production facility. The critical question here is whether or not the upstream process relinquishes its claim on the initial ‘net bonus’ when it supplies the CO<sub>2</sub> to the CCU system or whether it has the right to claim at least some the bonus? Based on current practice, it seems likely that bioethanol manufacturers will want their carbon inventory to include benefits from any downstream CCR for their ‘waste product’ CO<sub>2</sub><sup>13</sup>. If this is done, the CO<sub>2</sub> utilisation stage would not be entitled to claim the same bonus for carbon storage. The question is therefore whether splitting the bonus equally between the two systems offers an adequate way to resolve this issue (see ‘Solution 3’ in Figure 128 below).

Real carbon sink only achieved with biogenic CO<sub>2</sub>

Fig. 128: Possible ways to account for the carbon sink that arises when the CCU system uses biogenic CO<sub>2</sub> from a multi-functional upstream process

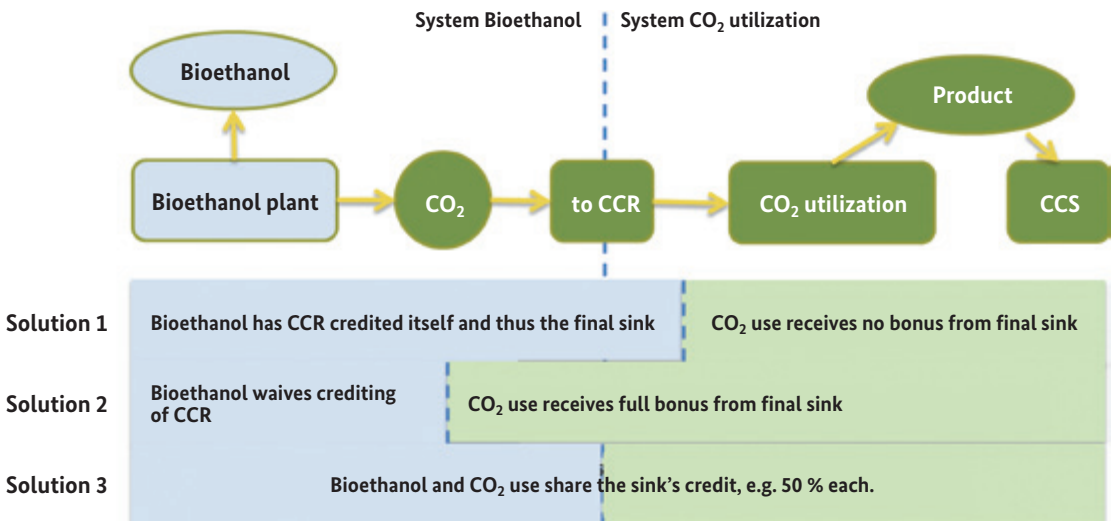

<sup>13</sup> e.g. in complete accordance with the GHG emissions methodology set out in Annex V to the RED.

The issue here is not deciding what is methodologically right or wrong, but preventing a situation in which both systems include the carbon sink in their carbon inventories.

### 4.4.4 Putting the three building blocks together

To compile a carbon inventory for a CCU system, the fundamental building blocks discussed above need to be brought together. This will be demonstrated using a simplified sample calculation described below and illustrated in Figure 129 and Figure 130.

Figure 129 and Figure 130 offer a means of comparing two systems that produce the same amount of thermal energy in the form of a transport fuel (20 MJ methanol or petrol) and the same amount of electrical energy (13.4 MJ). The baseline scenario in Figure 130, which is a reasonable reflection of the situation today, involves the production of petrol from crude oil (15 g CO<sub>2</sub>-eq. per kg of petrol supplied) and its subsequent combustion in a motor vehicle (90 kg CO<sub>2</sub>-eq. per GJ NCV) and the simultaneous generation of electricity in a gas-fired power plant (electric efficiency: 50%, NCV natural gas: 45 MJ/kg). In the other scenario shown in Figure 129, electricity is also generated from natural gas, but in this case the CO<sub>2</sub> formed is captured (capture efficiency: 100%; energy requirements for capture process: 2.5 MJ/kg CO<sub>2</sub>; power plant efficiency: 42%). The captured CO<sub>2</sub> then reacts with hydrogen to produce synthesis gas (a CO/H<sub>2</sub> mix) that is subsequently converted to methanol (with process-related losses of CO<sub>2</sub>). The methanol is combusted in motor vehicles (1.4 kg CO<sub>2</sub>-eq. per kg methanol). As methanol has

Fig. 129: Sankey diagram of a scenario involving the generation of thermal and electrical energy by utilising CO<sub>2</sub> from power plant flue gases to produce methanol

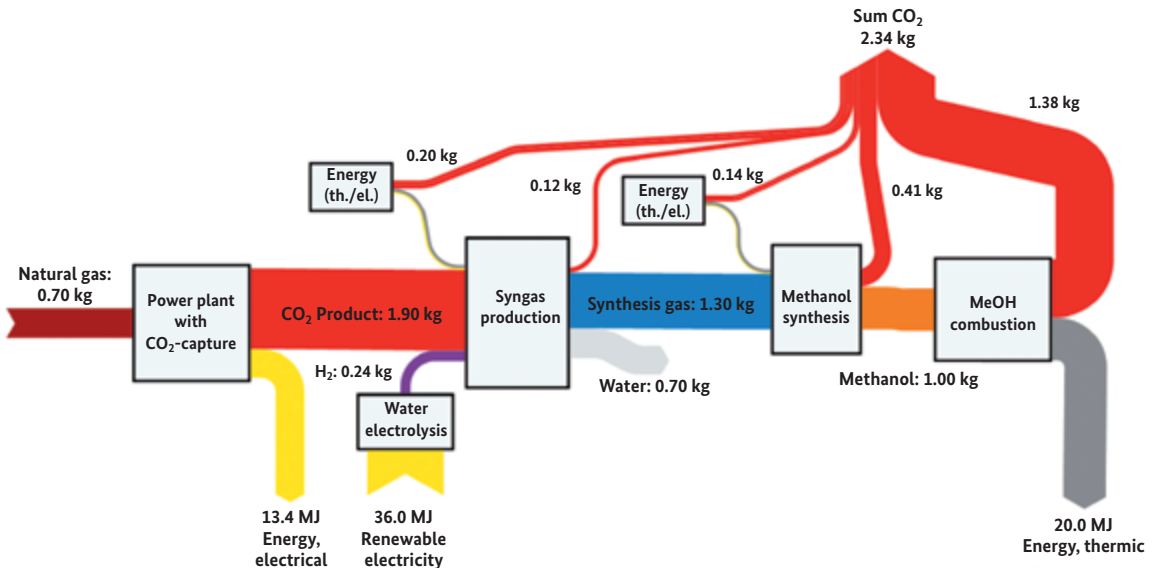

a calorific value of only 20 MJ/kg compared to about 40 MJ/kg for petrol, twice as much methanol needs to be produced. In this example, the hydrogen required for the synthesis is generated by electrolysing water in a process powered by electricity from a renewable (solar/wind/hydro) source that does not introduce any additional CO<sub>2</sub> burden. The electrical and thermal energy needed for the other conversion processes is supplied by a gas-fired CHP plant.

Direct comparison of these two systems, which produce the same beneficial outputs (i.e. generate the same quantities of electrical and thermal energy), shows that secondary utilisation of the CO<sub>2</sub> in a product can lead to a reduction in overall emissions (2.2 kg CO<sub>2</sub>-eq. vs 3.4 kg CO<sub>2</sub>-eq.). It also demonstrates that examining the entire life cycle enables unambiguous conclusions to be drawn regarding the advantages or disadvantages of a particular production system. Nevertheless, the question of how to allocate emissions among the different processes still arises. This will now be done on the basis of the methods presented and discussed earlier:

1. The concept of the ‘recycled portion’ allocates the burdens from primary energy, raw material extraction etc. to the primary product, whereas the environmental costs of collecting and treating waste are assigned to the secondary product (Guinée, Heijungs, & Huppes, 2004). Theoretically separating electricity generation and CO<sub>2</sub> capture shows that GHG emissions of 1.6 kg CO<sub>2</sub>-eq. are associated with the production of 13.4 MJ of electrical energy without carbon capture. If CO<sub>2</sub> is captured, this value increases to 1.9 kg CO<sub>2</sub>-eq. for the production of the same amount of electricity.

Fig. 130: Sankey diagram of a scenario in which thermal and electrical energy are generated in separate processes

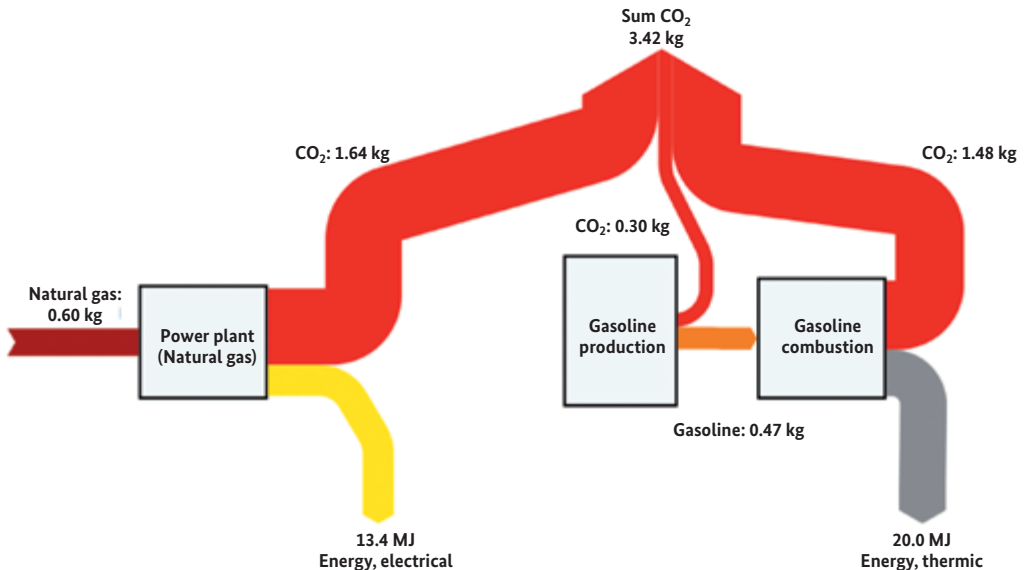

This can be interpreted to mean that the additional 0.3 kg of CO<sub>2</sub> is an unavoidable consequence of the carbon capture process that reflects the additional energy needed for CO<sub>2</sub> capture; if there was no carbon capture, this additional emission would not occur. As a result, a burden of 1.6 kg CO<sub>2</sub>-eq. continues to be allocated to the electricity (as if no CO<sub>2</sub> capture occurs), while the thermal energy stream is allocated 0.3 kg CO<sub>2</sub>-eq. from the power plant and from the CO<sub>2</sub> emissions from the processes involved in methanol production (in total: 0.6 kg CO<sub>2</sub>-eq.).

2. If the '50:50 method' (Detzel et al. 2016) is applied, the CO<sub>2</sub> emissions from the end-of-life combustion stage and the losses incurred during the various conversion processes (= entire quantity of captured CO<sub>2</sub>) are distributed equally between the electricity and thermal energy generating pathways (with 0.95 kg allocated to each). The CO<sub>2</sub> emissions burden from the processes involved in methanol production continue to be assigned to the thermal energy stream, thermal energy production is allocated a total GHG emissions burden of 1.25 kg CO<sub>2</sub>-eq.
3. The requirement in the EU Directives for 'zero emissions' combustion of the methanol means that no emissions burden may be assigned to the thermal energy generated when the methanol is combusted. However, it is not clear how the process-related losses totalling 0.5 kg CO<sub>2</sub>-eq. should be dealt with. If these losses are assigned to the methanol production, the thermal energy stream would have a burden of 0.8 kg CO<sub>2</sub>-eq. and the electrical energy stream a burden of 1.4 kg CO<sub>2</sub>-eq. Otherwise, the electrical energy would be allocated a burden of 1.9 kg CO<sub>2</sub>-eq. while the thermal energy would be generated with a burden of only 0.3 kg CO<sub>2</sub>-eq.

## 4.5 Summary

Carbon dioxide has the potential to play a significant role in future as a raw material for the production of resource-friendly and climatically benign fuels and as feedstock for the chemical industry. CO<sub>2</sub> utilisation is therefore a means to help reduce industry's carbon footprint. It is, however, crucial that the contributions to carbon reduction from CO<sub>2</sub> capture and utilisation (CCU) schemes are calculated using methods that are well-founded and that meet the requirements of generally accepted good accounting practice.

A large number of internationally accepted standards and guidelines (e.g. ISO standards) already exist that provide an established set of general rules and methodological principles. In some areas, statutory requirements (e.g. the EU Directives RED and FQD) also provide appropriate guidance. Achie-

ving a consistent carbon accounting framework for calculating the carbon footprints of CCU products is therefore not an insoluble problem.

Nevertheless, tackling this particular task raises a series of specific challenges concerning the best approach to take and for which the standard publications in the field offer little in the way of guidance. Although there is ongoing research in the field aimed at filling the existing gaps, and although the scientific and professional literature contains recommendations on diverse aspects of the problem, the issues involved are relatively new and the technological processes and techniques that need to be assessed are very varied and are also undergoing very dynamic development at present.

This report aims to

- provide a broad overview of the carbon accounting rules at all levels
- highlight the core aspects that make carbon accounting procedures for CCU products so complex
- provide readers with the guidance necessary to enable them to deal with the main compartments along the entire CCU product life cycle.

This report has been compiled principally as a contribution to the current specialist discussions on what looks to be an increasingly significant area of technology. Nevertheless, this report cannot include and address all of the many questions arising in relation to this important topic.

Finally, we wish to underscore the fact that carbon footprints provide a means of assessing the impact of CCU systems on only one specific environmental aspect, albeit a very significant one. It is frequently the case that the use of fossil resources or the emissions generated from fuel combustion (acidification, eutrophication, summer smog, respirable dust, etc.) result in negative assessments in other environmental impact categories. There are, however, environmental impact categories that do not behave analogously to the GHG emissions inventory. When biomass is used as a replacement for fossil-based energy sources, for example, the associated climate benefits can, in certain circumstances, be obtained to the detriment of biodiversity. It is particularly important when analysing processes that are expected to have a favourable carbon footprint but are technically complex to implement that special care is taken to examine environmental impacts beyond just greenhouse gas emissions.

## References:

- BMUB (2016): Klimaschutzplan 2050 - Klimaschutzpolitische Grundsätze und Ziele der Bundesregierung, BMUB-Hausentwurf vom 06.09.2016 [*Climate Action Plan 2050 – Principles and Objectives of Federal Climate Policy – In-house draft of 6 Sept. 2016 issued by the Federal Ministry for the Environment, Nature Conservation, Building and Nuclear Safety*]; <http://www.klimaschutzplan2050.de/>
- BMUB (2016a): Verordnung zur Anrechnung von strombasierten Kraftstoffen und mitverarbeiteten biogenen Ölen auf die Treibhausgasquote – 37. BImSchV; Referentenentwurf vom 19.08.2016 [*37th Ordinance for the Implementation of the Federal Immission Control Act (BImSchV) Concerning the Crediting of Electrofuels and Concomitantly Processed Biogenic Oils to the GHG Quota; dated 19 August 2016*]
- BMUB (2015): Klimaschutz in Zahlen - Fakten, Trends und Impulse deutscher Klimapolitik, Ausgabe 2015 [*Climate Protection Policy: Facts, Figures, Trends and Initiatives in Germany's Climate Policy; 2015 Edition*]
- Brandão, M.; Levasseur, A.; Kirschbaum, M.; Weidema, B.; Cowie, A.; Jørgensen, V.; Hauschild, M.; Pennington, D.; Chomkham Sri, K. (2012): Key issues and options in accounting for carbon sequestration and temporary storage in life cycle assessment and carbon footprinting, in: *The International Journal of Life Cycle Assessment*, Vol. 18, 2012, Issue 1, p. 230–240.
- Consentec, ifeu, Fraunhofer ISI (2016) *Langfristszenarien und Strategien für den Ausbau der Erneuerbaren Energien in Deutschland unter besonderer Berücksichtigung der nachhaltigen Entwicklung sowie regionaler Aspekte*; in Kooperation mit; im Auftrag des Bundesministeriums für Wirtschaft und Energie; laufendes Projekt [*Long-range Scenarios and Strategies for the Expansion of Renewable Energy Resources in Germany with Special Emphasis on Sustainable Development and Regional Aspects; Ongoing project on behalf of the Federal Ministry for Economic Affairs and Energy*]
- Detzel, A., Kauertz, B., Grahl, B., Heinisch, J. (2016): Prüfung und Aktualisierung der Ökobilanzen für Getränkeverpackungen; im Auftrag des Umweltbundesamts; FKZ-No.: 3711 92 315; Series: 'Texte 19/2016' [*Evaluation and Updating of LCAs for Beverage Packaging; On behalf of the Federal Environment Agency*]; <http://www.umweltbundesamt.de/publikationen/pruefung-aktualisierung-der-oekobilanzen-fuer>
- Edwards (2016): *Proposed Principles for Calculating Emissions from Renewable Fuels of Non-Biological Origin (REFUNOBIOs) and CCU Fuels (CCUFs)*; input into MS expert group on FQD7a implementation 28-06-2016
- EU (2016): Vorschlag für einen Beschluss des Rates über den Abschluss des im Rahmen des Rahmenübereinkommens der Vereinten Nationen über Klimaänderungen geschlossenen Übereinkommens von Paris im Namen der Europäischen Union [*Proposal for a Council Decision on the conclusion, on behalf of the European Union, of the Paris Agreement adopted under the United Nations Framework Convention on Climate Change*]; Brussels, 10 June 2016 COM(2016) 395 final
- EU Directive (EU) 2015/1513 (iLUC Directive) of 9 September 2015: amending Directive 98/70/EC relating to the quality of petrol and diesel fuels and amending Directive 2009/28/EC on the promotion of the use of energy from renewable sources
- EU Directive (EU) 2015/652 of 20 April 2015: laying down calculation methods and reporting requirements pursuant to Directive 98/70/EC of the European Parliament and of the Council relating to the quality of petrol and diesel fuels
- EU Directive (EU) 2009/28/EC (RED) of 23 April 2009: on the promotion of the use of energy from renewable sources and amending and subsequently repealing Directives 2001/77/EC and 2003/30/EC
- EU Directive 2009/30/EC (FQD) of 23 April 2009: amending Directive 98/70/EC as regards the specification of petrol, diesel and gas-oil and introducing a mechanism to moni-



- tor and reduce greenhouse gas emissions and amending Council Directive 1999/32/EC as regards the specification of fuel used by inland waterway vessels and repealing Directive 93/12/EEC
- Frischknecht, R. (2010). LCI modelling approaches applied on recycling of materials in view of environmental sustainability, risk perception and eco-efficiency. *The International Journal of Life Cycle Assessment*, 15(7), 666–671. <https://doi.org/10.1007/s11367-010-0201-6>
- Guinée, J. B., Heijungs, R., & Huppes, G. (2004). Economic allocation: Examples and derived decision tree. *The International Journal of Life Cycle Assessment*, 9(1), 23–33. <https://doi.org/10.1007/BF02978533>
- IPCC (2006): *Guidelines for National Greenhouse Gas Inventories*; <http://www.ipcc-nggip.iges.or.jp/public/2006gl/>
- IPCC (2013): *The Physical Science Basis. Working Group I contribution to the IPCC Fifth Assessment*; Editor: Intergovernmental Panel on Climate Change. 30 September 2013, <http://www.ipcc.ch/report/ar5/wg1/>
- JRC (2010): *International Reference Life Cycle Data System (ILCD) – General guide for Life Cycle Assessment – Detailed guidance*. First edition March 2010. EUR 24708 EN. Luxembourg. Publications Office of the European Union; 2010
- JRC (2016): *Data requirements and principles for calculating the life cycle GHG intensity of novel fuels for transport purposes and invitation to submit data*; internal draft from 16/06/2016
- Rabl, A., Benoist, A., Dron, D., Peupartier, B., Spadaro, J.V., Zoughraib, A. (2007): How to account for CO<sub>2</sub> emissions from biomass in an LCA; *The International Journal of Life Cycle Assessment*, 2007(12), 281.
- UBA (2016): Klimaschutz und regenerativ erzeugte chemische Energieträger – Infrastruktur und Systemanpassung zur Versorgung mit regenerativen chemischen Energieträgern aus in- und ausländischen regenerativen Energien [*Climate Protection and Renewable Chemical Fuels – Infrastructure and System Modifications Relating to the Supply of Chemical Fuels Manufactured using Foreign and Domestic Sources of Renewable Energy*]; 08/2016
- UBA (2013): Treibhausgasneutrales Deutschland im Jahr 2050 [*Achieving Greenhouse Gas Emissions Neutrality in Germany by 2050*]; Federal Environment Agency, Series: *hintergrund* // October 2013
- UBA (2002): Ökobilanz für Getränkeverpackungen II / Phase 2; Studie von Prognos und ifeu; [*LCA for Beverage Packaging II / Phase 2; Study performed by Prognos and ifeu*] On behalf of the Federal Environment Agency; Series: 'Texte 51/02'
- von der Assen, N.; Bardow, A. (2014): Life cycle assessment of polyols for polyurethane production using CO<sub>2</sub> as feedstock: insights from an industrial case study, in: *Green Chemistry*, Vol. 16, 2014, Issue 6, p. 3272–3280.
- von der Assen, N.; Jung, J.; Bardow, A. (2013a): Life-cycle assessment of carbon dioxide capture and utilization: avoiding the pitfalls, in: *Energy Environ. Sci.*, Vol. 6, 2013, Issue 9, p. 2721–2734.
- von der Assen, N.; Voll, P.; Peters, M.; Bardow, A. (2013b): Life cycle assessment of CO<sub>2</sub> capture and utilization: a tutorial review, in: *Chemical Society Reviews*, Vol. 43, 2013, Issue 23, p. 7982–7994.
- von der Assen, N.; Müller, L. J.; Steingrube, A.; Voll, P.; Bardow, A. (2016): Selecting CO<sub>2</sub> Sources for CO<sub>2</sub> Utilization by Environmental-Merit-Order Curves, in: *Environmental science & technology*, Vol. 50, 2016, Issue 3, p. 1093–1101.

- Weidema, B. (2000). Avoiding Co-Product Allocation in Life-Cycle Assessment. *Journal of Industrial Ecology*, 4(3), 11–33. <https://doi.org/10.1162/108819800300106366>
- WRI, WBCSD (2008): *Product Life Cycle Accounting and Reporting Standard*; World Resources Institute und World Business Council for Sustainable Development; <http://ghgprotocol.org/standards/product-standard>
- Yu, C.-H., Huang, C.-H., & Tan, C.-S. (2012). A Review of CO<sub>2</sub> Capture by Absorption and Adsorption. *Aerosol and Air Quality Research*, 12, 745–769.
- Zech, K., K. Naumann, F. Müller-Langer, J. Ponitka, S. Majer, P. Schmidt, W. Weindorf, M. Altmann, J. Michalski, M. Niklaß, H. Meyer, A. Lischke, H. Fehrenbach, J. Jöhrens, S. Markwardt: *Biokerosin und EE-Kerosin für die Luftfahrt der Zukunft – von der Theorie zu Pilotvorhaben; Studie im Rahmen der Mobilität und Kraftstoffstrategie für das Bundesministerium für Verkehr und digitale Infrastruktur (BMVI) [Biokerosene and RES-Kerosene for the Aviation Industry of the Future – From Theory to Pilot Project; Study carried out as part of the mobility and transport fuels strategy of the Federal Ministry of Transport and Digital Infrastructure (BMVI)]*; Leipzig, Munich, Berlin, Heidelberg, 2016

---

---

---

---

---

---

---

---